

INTEGRA[®]
LIMIT UNCERTAINTY

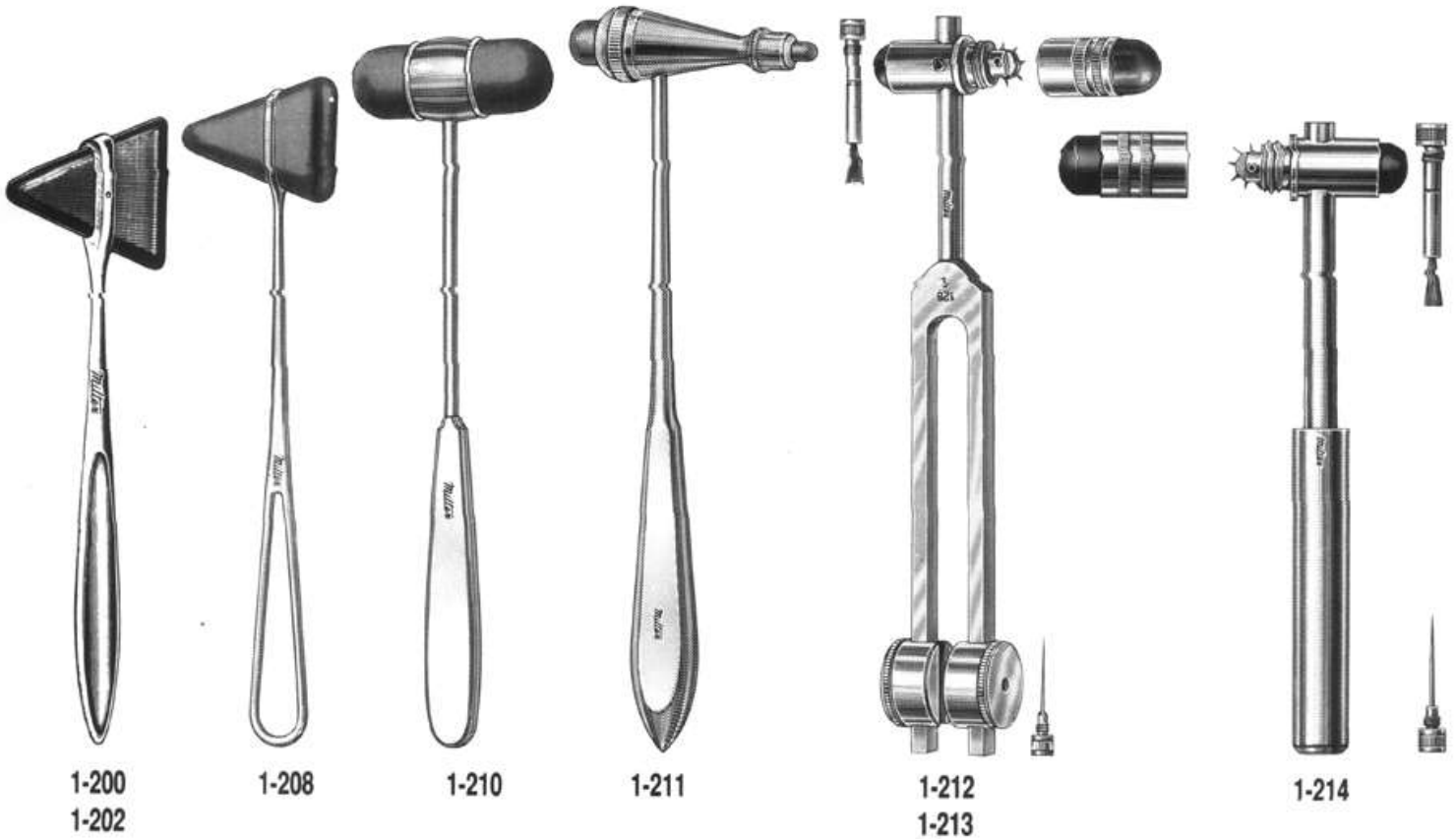

Integra[®] Miltex[®]
Surgical Instruments



- 1-200** TAYLOR Percussion Hammer 7" (17.8 cm), Pediatric Size, solid handle
- 1-202** TAYLOR Percussion Hammer 7 1/2" (19.1 cm), Standard Size, solid handle, chrome
- 1-208** TAYLOR Percussion Hammer 9" (22.9 cm), Large Head, loop handle, chrome
- 1-210** DEJERINE Percussion Hammer 9 1/2" (24.1 cm), chrome
- 1-211** TROMNER Percussion Hammer 9 3/4" (24.8 cm), with Large and Small Rubber Tips, hollow tapered handle with sharp point, chrome
- 1-212** COMBO-5 Neuro Diagnostic Set (C-128 Tuning Fork, Buck Hammer, Pin Wheel, Brush and Needle)
- 1-213** COMBO-5 Neuro Diagnostic Set (C-256 Tuning Fork, Buck Hammer, Pin Wheel, Brush and Needle)
- 1-214** COMBO-4 Neuro Diagnostic Set (Buck Hammer, Pin Wheel, Brush and Needle)
- 1-220** BUCK Neurological Hammer 7 3/4" (19.7 cm), with Brush and Needle (screw into handle), chrome
- 1-222** RABINER Neurological Hammer 9" (22.9 cm), with Brush and Needle (screw into handle), chrome

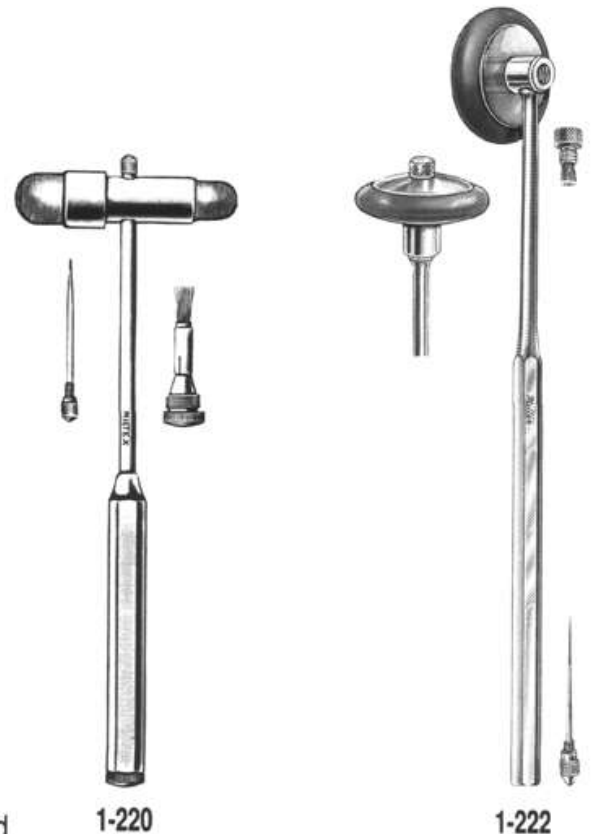



19-100



19-102

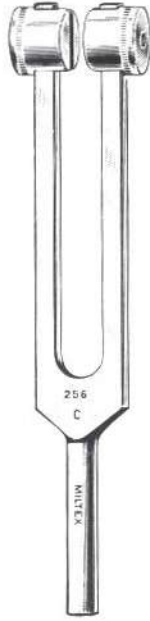

19-104

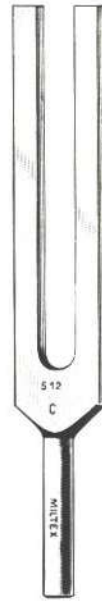

19-106



19-108



19-110



19-112

MILTEX TUNING FORKS,
Aluminum Alloy

- 19-100
- 19-102
- 19-104
- 19-106
- 19-108
- 19-110
- 19-112

- C-64 vibrations
- C-128 vibrations
- C-256 vibrations
- C-512 vibrations
- C-1024 vibrations
- C-2048 vibrations
- C-4096 vibrations

19-120

Set of 5 Tuning Forks,
C-128, C-256, C-512,
C-1024 and C-2048 in
fitted zippered case

19-120A

Fitted zippered case only
for tuning fork set



19-120
19-120A

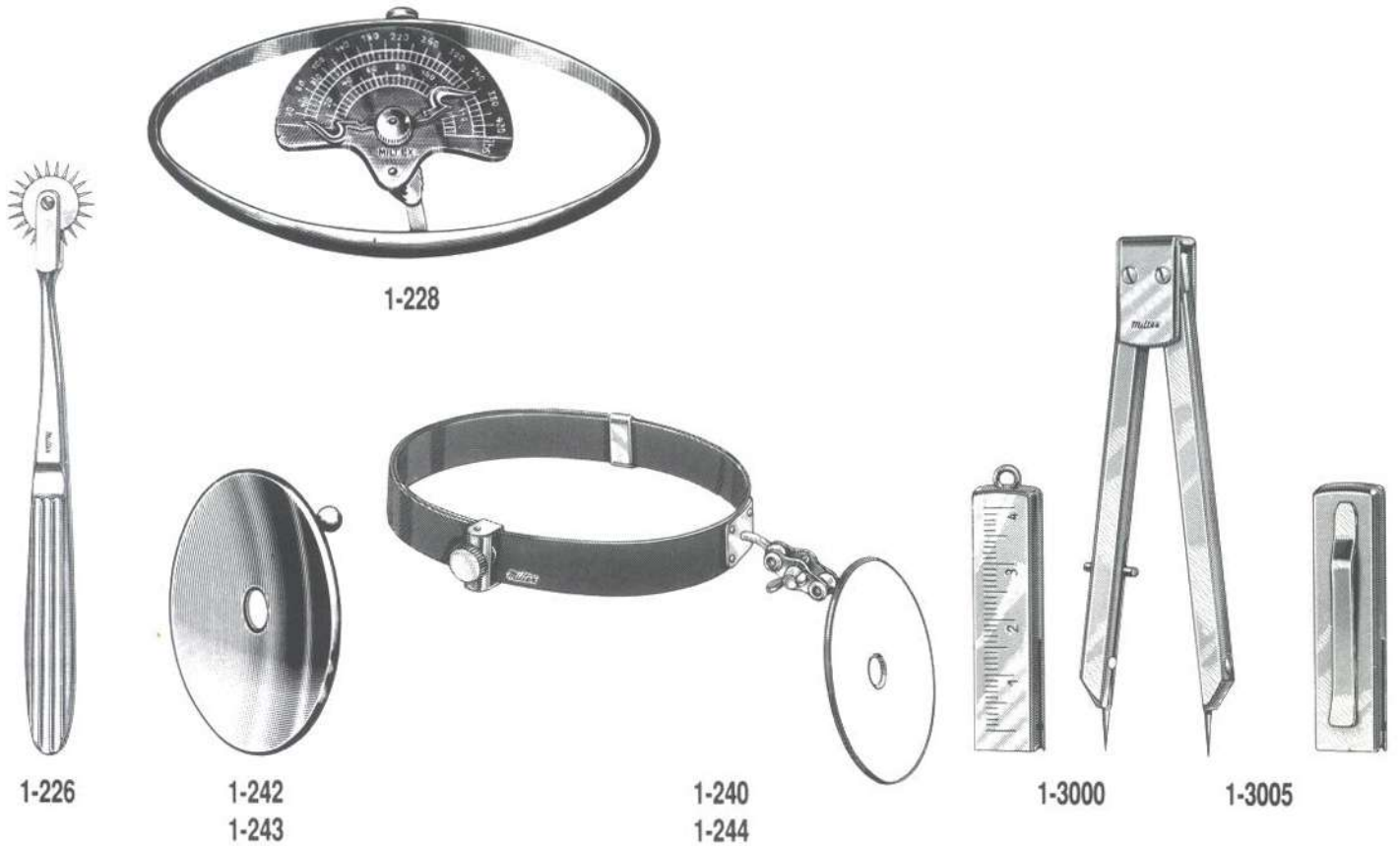

- 1-226** WARTENBERG Neurological Pin Wheel 7" (17.8 cm)
- 1-228** COLLIN Dynamometer, Adult size, 5" x 2 ¼" (12.7 x 5.7 cm)
- 1-240** FRANKEL Head Band and Mirror Set. Includes Standard 3 ½" (8.9 cm) dia. mirror with ½" (1.3 cm) aperture and improved model Frankel Head Band No. 1-244
- 1-242** MILTEX Head Mirror, Standard size 3 ½" (8.9 cm) dia. with ½" (1.3 cm) aperture, boilable
- 1-243** MILTEX Head Mirror, Small size 3" (7.6 cm) dia. with ⅝" (1.6 cm) aperture, boilable
- 1-244** FRANKEL Head Band, Black fibre material, improved pattern with secure thumb screw size adjustment; includes swivel mirror connector
- 1-3000** EKG Caliper, with protective metal cap, graduated in mm, and ring, satin chrome finish
- 1-3005** EKG Caliper, with protective metal cap, graduated in mm, and pocket clip, satin chrome finish
- 1-3015** EKG Caliper, Economy line, with protective black plastic cap, graduated in mm, nickel plated

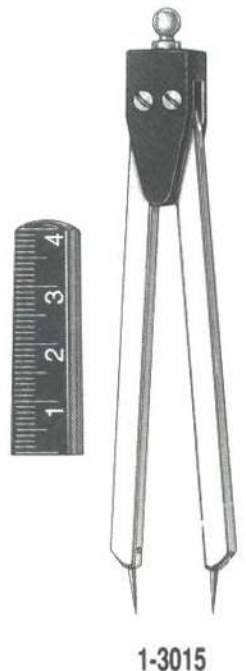



1-3200



1-4000
1-4006



1-4010



1-4

- 1-3200** MILTEX Fibreglass Tape Measure, 1/4" (6.4 mm) wide, graduated to 60" (152.4 cm) on one side, to 150 cm on other side. Plastic case with pushbutton tape return
- 1-4000** MILTEX Binocular Magnifying Loupe, lightweight, coated optics 1.8X magnification, 30 cm focal distance, 10 cm viewing area, pupillary distance adjustment, mounted on spectacle frame. With carrying case
- 1-4006** MILTEX Binocular Magnifying Loupe, same as No. 1-4000, but without spectacle frame and without case
- 1-4010** Accessory Clip-On Lenses, for No. 1-4000 and 1-4006 Loupes, increasing magnification to 2.5X, with 17 cm focal distance, 4.5 cm viewing area
- 1-4** FORD Stethoscope with shallow bell and plastic ear tips, chrome



2-20



2-50

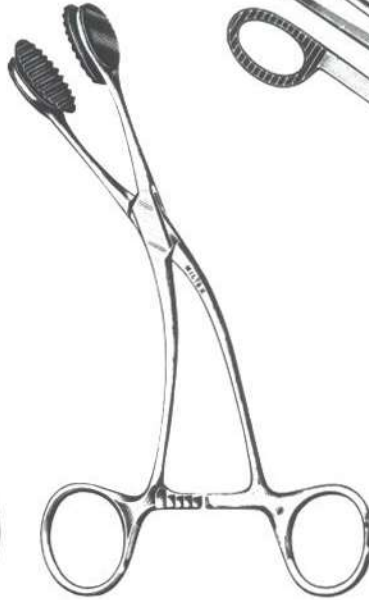

2-60
2-62

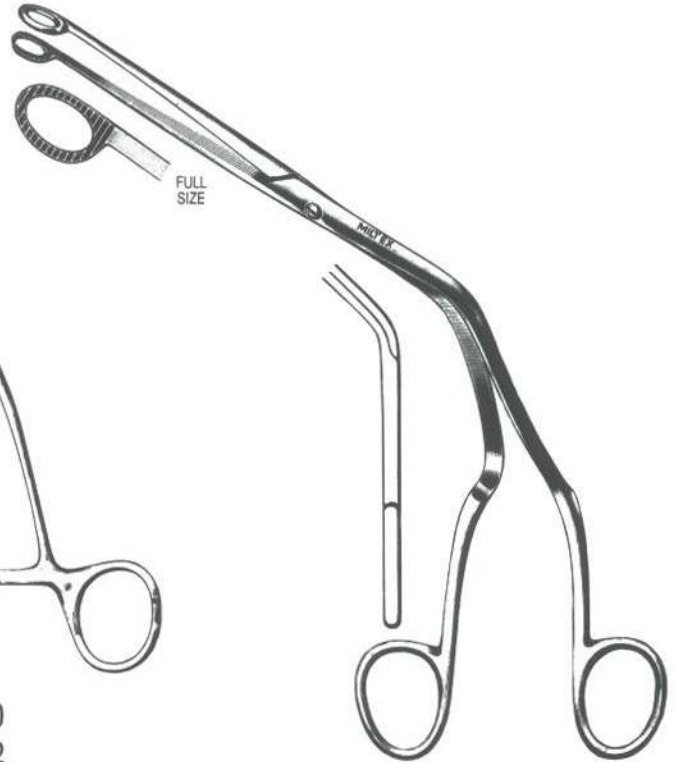

2-70
2-72

- 2-20 MAUNDER Oral Screw, white plastic
- 2-50 COLLIN Tongue Seizing Forceps 6 3/4" (17.1 cm) jaws 25mm wide
- 2-60 YOUNG Tongue Seizing Forceps 6 1/2" (16.5 cm), with soft rubber jaws
- 2-62 RUBBER JAWS for Young Tongue Forceps
- 2-70 MAGILL Endotracheal Catheter Introducing Forceps 9" (22.9 cm), adult size
- 2-72 MAGILL Endotracheal Catheter Introducing Forceps 7" (17.8 cm), child size
- 2-104 YANKAUER Suction Tube 11 3/4" (29.8 cm), with removable tip and tubing connection, chrome
- 2-104SS YANKAUER Suction Tube 11 3/4" (29.8 cm), with removable tip and tubing connection
- 2-106 Tip for YANKAUER Suction Tube, chrome
- 2-106SS Tip for YANKAUER Suction Tube



2-104
2-104SS



FULL SIZE

2-106
2-106SS



- 2-100** PYNCHON Suction Tube 11" (27.9 cm), tip with large openings, with removable tubing connection, chrome
- 2-109** YANKAUER Pediatric Suction Tube 8 1/2" (21.6 cm), with removable tip, delicate pattern
- 2-110** ANDREWS-PYNCHON Suction Tube 10" (25.4 cm), delicate pattern, chrome
- 2-110SS** ANDREWS-PYNCHON Suction Tube 10" (25.4 cm), delicate pattern
- 2-120** DAVIS Mouth Gag 6 1/4" (15.9 cm), double bite, left, without blades
- 2-122** DAVIS Mouth Gag 6 1/4" (15.9 cm), double bite, right, without blades

BLADES FOR DAVIS OR McIVOR MOUTH GAGS

W/o Ether Tube	Size No.	Size		W/Ether Tube
2-130	1	3/4" x 1"	(1.9 x 2.5 cm) Tooth Plate	—
2-132	2	1" x 2 3/4"	(2.5 x 7 cm) Tongue Blade	2-132A
2-134	3	1" x 3 1/4"	(2.5 x 8.3 cm) Tongue Blade	2-134A
2-136	4	1" x 3 3/4"	(2.5 x 9.5 cm) Tongue Blade	2-136A
2-138	5	1" x 4"	(2.5 x 10.2 cm) Tongue Blade	2-138A

RING TONGUE RETRACTOR BLADES

For use with Davis or McIvor Mouth Gags. Grooved blade holds endotracheal tube firmly in place.

Left	Size No.	Size	Right
2-140	2	7/8" x 2 1/4"	(2.2 x 5.7 cm) 2-144
2-141	3	1 1/8" x 3"	(2.9 x 7.6 cm) 2-145
2-142	4	1 1/4" x 3 1/2"	(3.2 x 8.9 cm) 2-146
2-143	5	1 1/2" x 3 3/4"	(3.8 x 9.5 cm) 2-147



2-140 to 2-147

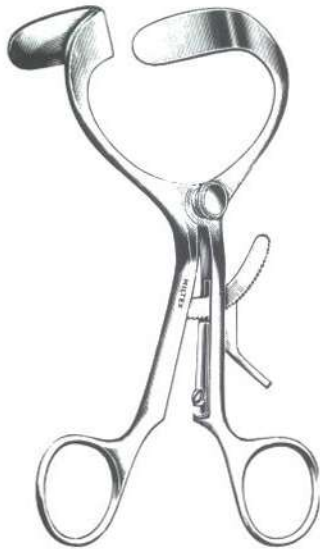

2-150



2-154



2-160
2-162
2-164

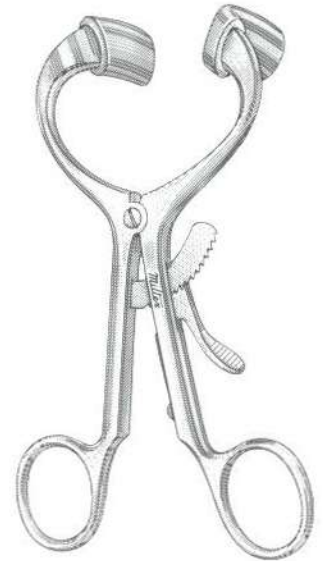

63-10
63-15
63-20

- 2-150** DOYEN-JANSEN Mouth Gag 5½" (14 cm), with grip lock
 - 2-154** DENHARDT Mouth Gag 5" (12.7 cm), with grip lock
 - 2-160** JENNINGS Mouth Gag, adult size, 6" (15.2 cm) wide
 - 2-162** JENNINGS Mouth Gag, child size, 4¾" (12.1 cm) wide
 - 2-164** JENNINGS Mouth Gag, infant size, 3¾" (9.5 cm) wide
 - 2-180** McIVOR Mouth Gag, 5¾" (14.6 cm), complete with 3 tongue blades, one each Nos. 2-132, 2-134 and 2-136
 - 2-182** McIVOR Mouth Gag, 5¾" (14.6 cm), frame only
- MOLT Mouth Gags with silicone guards
- 63-10** Pediatric 4" (10.7 cm)
 - 63-15** Child 4½" (11.4 cm)
 - 63-20** Adult 5½" (14 cm)

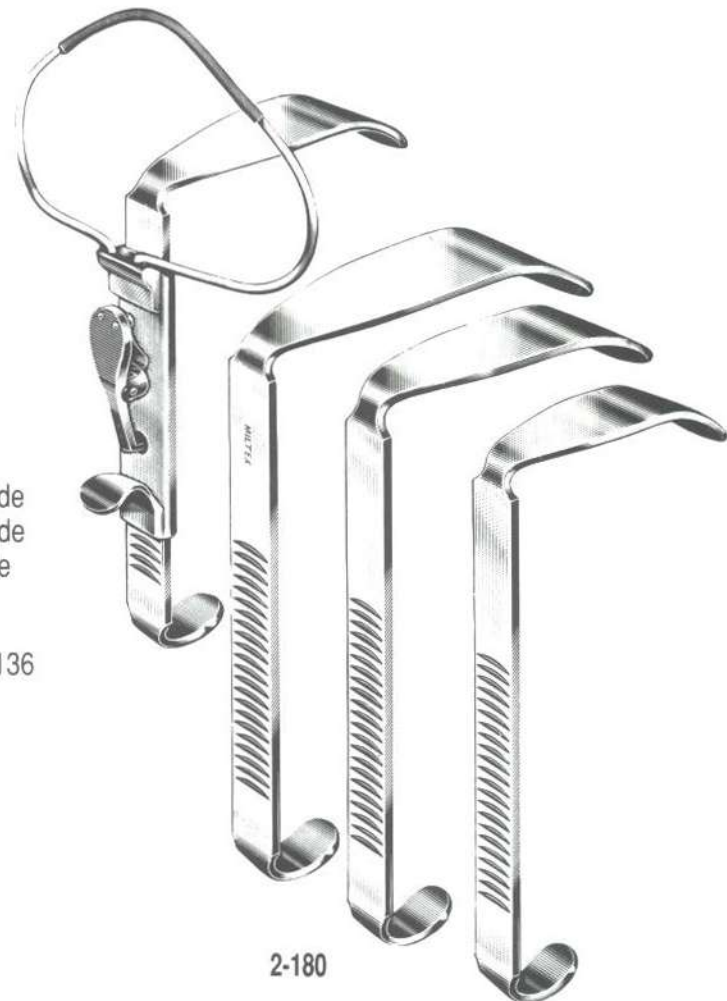

2-180

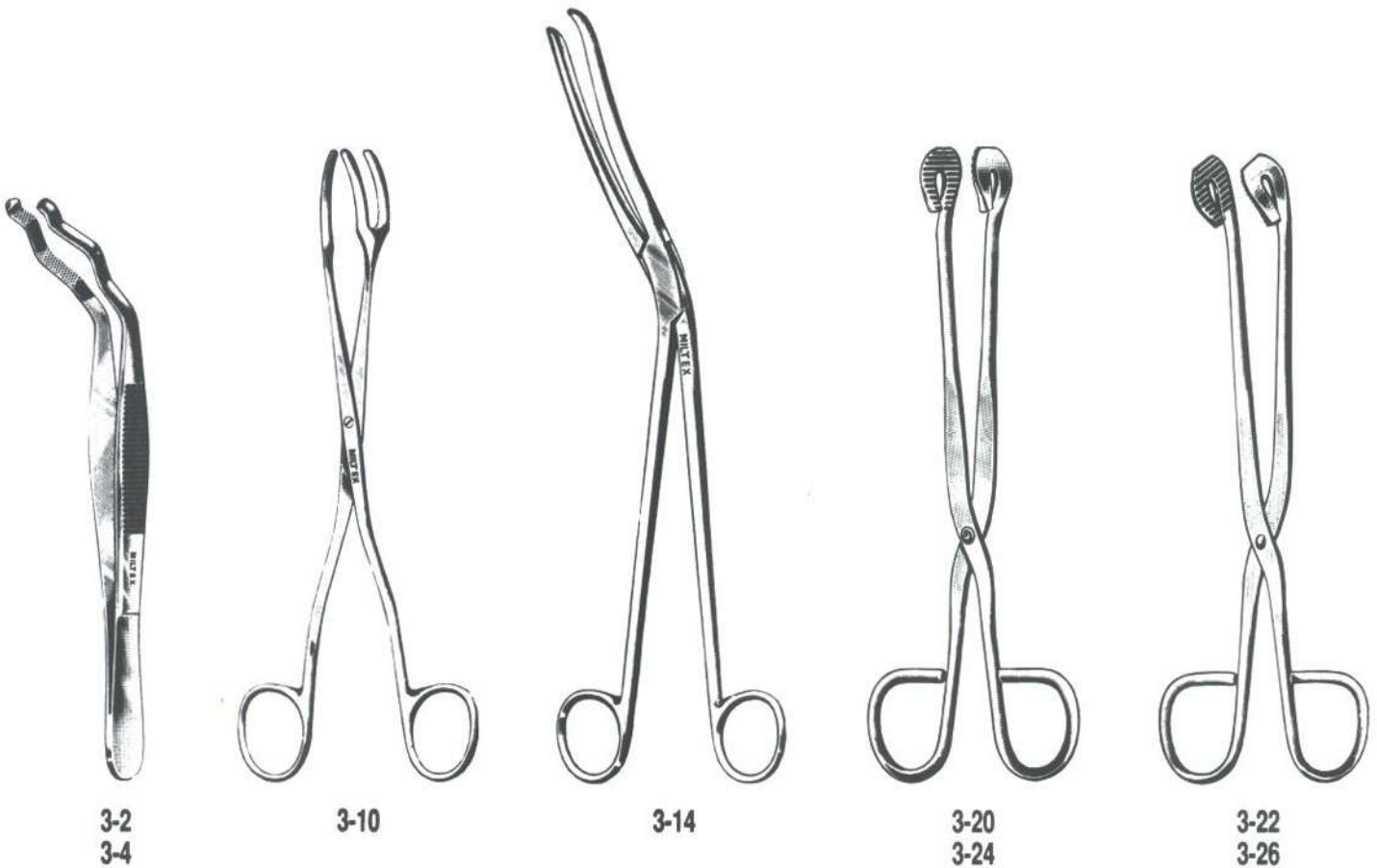

- 3-2 DAVIS Sterilizer Forceps 6" (15.2 cm)
- 3-4 DAVIS Sterilizer Forceps 10" (25.4 cm)
- 3-10 Three Prong Sterilizer Forceps 8" (20.3 cm)
- 3-14 CHEATLE Sterilizer Forceps 11" (27.9 cm)
- 3-20 Utility-Sterilizer Forceps 8" (20.3 cm), straight
- 3-22 Utility-Sterilizer Forceps 8" (20.3 cm), curved
- 3-24 Utility-Sterilizer Forceps 11" (27.9 cm), straight
- 3-26 Utility-Sterilizer Forceps 11" (27.9 cm), curved

- 3-50 Sterilizer Spiral Rack for surgical needles
- 3-60 BUNT Forceps Holder

- 65-25 Grasping Forceps 6 1/4" (15.9 cm)
Designed to grasp instruments from the ultrasonic and cold sterilization solution trays, containers and baskets.

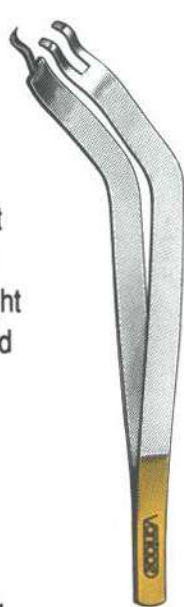

65-25



3-50



3-60



3-70 to 3-74

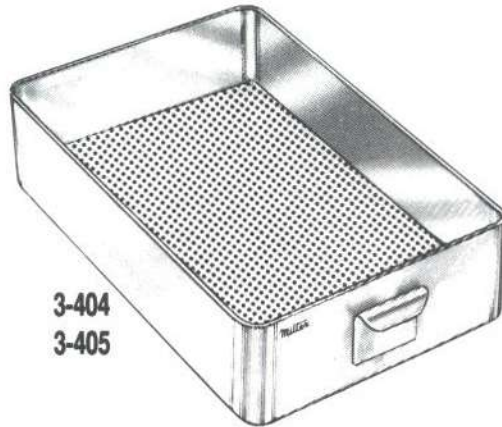

3-404
3-405

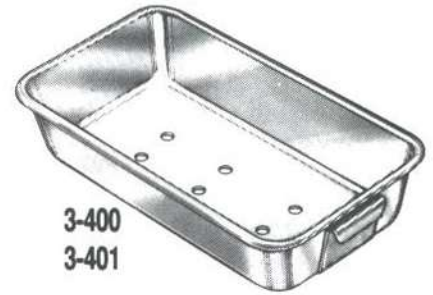

3-400
3-401

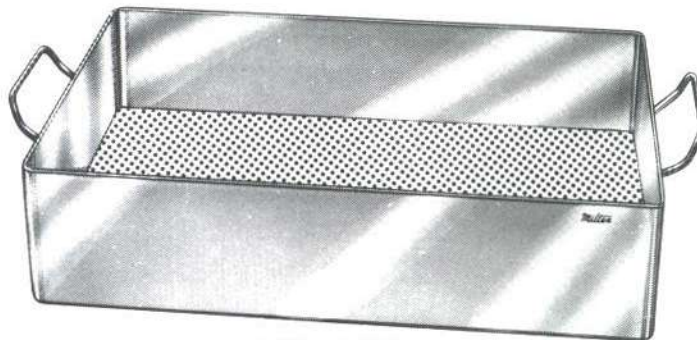

3-499 to 3-502



3-402



65-28

- 3-70 MILTEX Forceps Holder 8" (20.3 cm), with secure locking device
- 3-71 MILTEX Forceps Holder 10" (25.4 cm), with secure locking device
- 3-72 MILTEX Forceps Holder 12" (30.5 cm), with secure locking device
- 3-74 MILTEX Forceps Holder 16" (40.6 cm), with secure locking device

- 3-400 Flash Autoclaving Pan 9" x 5" x 2" (22.9 x 12.7 x 5.1 cm) with drainage holes, including safety handle
- 3-401 Flash Autoclaving Pan only
- 3-402 Safety Handle only
- 3-404 Flash Autoclaving Tray 10" x 6 1/2" x 2 1/2" (25.4 x 16.5 x 6.4 cm) with perforated bottom, including safety handle
- 3-405 Flash Autoclaving Tray only

INSTRUMENT STERILIZING TRAYS

With handles. Rolled safety edges. Perforated bottoms assure complete steam penetration with no build-up of condensation.

- 3-499 Outside Dimensions 10" x 6 1/2" x 2 1/2" (25.4 x 16.5 x 6.4 cm)
- 3-500 Outside Dimensions 10" x 10 1/2" x 3 1/2" (25.4 x 26.7 x 8.9 cm)
- 3-501 Outside Dimensions 15" x 10 1/2" x 3 1/2" (38.1 x 26.7 x 8.9 cm)
- 3-502 Outside Dimensions 20" x 10 1/2" x 3 1/2" (50.8 x 26.7 x 8.9 cm)

- 65-28 Mesh Holder, 6 3/4" (17.1 cm), 2 1/8" (5.4 cm) inside diameter of basket, securely holds small items such as micro clips, screws, burs etc., during cleaning, rinsing or sterilization



3-550 to 3-554



3-620 3-628
3-624 3-640



3-570 to 3-576

MICRO INSTRUMENT STERILIZING CASES

With handles and removable cover. Double rows of pins welded to bottom hold instruments in place. Strips of silicone rubber cushions on bottom and cover give added protection to instruments. Perforated cover and bottom assure complete heat penetration with no build-up of condensation. All edges rolled for safety. Easily operated lock holds cover securely.

- 3-550 Outside Dimensions 8" x 8 1/2" x 1 1/4" (20.3 x 21.6 x 3.2 cm)
- 3-552 Outside Dimensions 8" x 12 1/4" x 1 1/4" (20.3 x 31.1 x 3.2 cm)
- 3-554 Outside Dimensions 10 1/2" x 10" x 1 1/2" (26.7 x 25.4 x 3.8 cm)

Same features as described above, except double rows of silicone rubber cushions on bottom are adjustable to lengths of instruments. Upper silicone rubber strips hold instruments securely.

- 3-570 Outside Dimensions 8 1/2" x 8" x 1 1/4" (21.6 x 20.3 x 3.2 cm)
- 3-572 Outside Dimensions 8 1/2" x 12" x 1 1/4" (21.6 x 30.5 x 3.2 cm)
- 3-574 Outside Dimensions 10 1/2" x 10" x 1 1/2" (26.7 x 25.4 x 3.8 cm)
- 3-576 Outside Dimensions 10 1/2" x 15" x 1 1/4" (26.7 x 38.1 x 3.2 cm)

"CTS" COLOR TRAY SYSTEM

Each tray measures 11 1/8" x 7 1/4" x 1 9/16" (28.2 x 18.4 x 4.1 cm). Lightweight anodized aluminum. Tops available in red, blue and silver. All tray bottoms are silver. Each tray supplied with 2 sets of pre-cut foam which are steam and EO permeable. *Not for use with Dry Heat or Cold Sterilizing Solutions.*

- 3-620 Red
- 3-624 Blue
- 3-628 Silver
- 3-640 Pre-Cut "CTS" Foam, 6 sets of 2

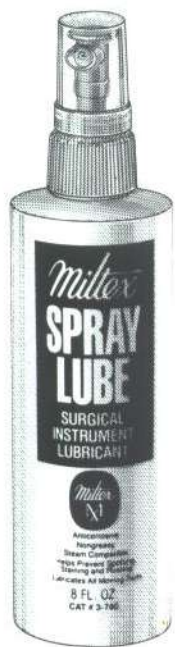

3-700



3-720

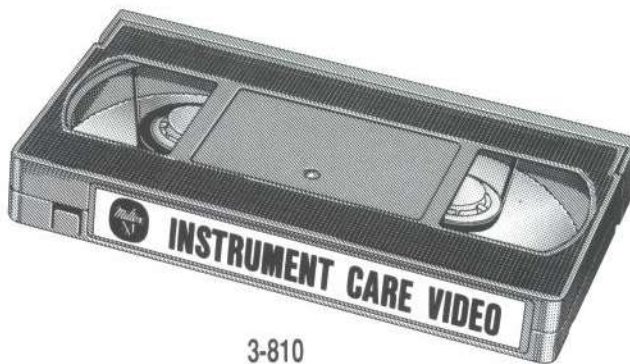

3-810



3-740



3-1000
3-1001

- 3-700** MILTEX Spray Lube. 8 oz. (.24 liter) bottles. Pre-mixed non-silicone water soluble formula in convenient pump spray bottles. Lubricates all moving parts on surgical instruments. (Case of 12)
- 3-720** MILTEX Surgical Instrument Cleaner. 8 oz. (.24 liter) bottles. Neutral pH formula for use in ultrasonic or manual cleaning of surgical instruments, glassware, plastic, metal or rubber goods. 8 oz. (.24 liter) yields 32 gal. (121 liters) of solution. (Case of 12)
- 3-740** MILTEX Surgical Instrument Stain Remover. 3 oz. (85 g) jars. Special powdered formula removes stains and tarnish, restores luster to surgical instruments, autoclaves, ultrasonic cleaners, stainless steel countertops, trays and stands. (Case of 12)
- 3-810** MILTEX Instrument Care Video. 25 minute instructional video offers step-by-step guidance on handling, cleaning, rinsing, inspecting, lubricating and sterilizing surgical instruments.
- 3-1000** MILTEX Instrument Cleaning Brushes 7 ¼" (18.4 cm). Nylon bristles. Designed to clean instruments without scratching or harming delicate surfaces. (Set of 3), Autoclavable
- 3-1001** MILTEX Instrument Cleaning Brushes 7 ¼" (18.4 cm). Stainless steel bristles. Designed to clean instrument serrations, rasps, files and burs. (Set of 3), Autoclavable
- 3-800** MILTEX Instrument Care System Kit (not shown). Kit contains one bottle of MilteX Spray Lube, one bottle of MilteX Surgical Instrument Cleaner, one jar of MilteX Surgical Instrument Stain Remover, one MilteX Instrument Care Video, one MilteX Nylon Bristle Cleaning Brush and one MilteX Stainless Steel Bristle Cleaning Brush. *This unique package of products also includes a copy of an instrument care instructional booklet for permanent reference.*

MSDS supplied with 3-700, 3-720, 3-740 & 3-800



3-2000



V97-584

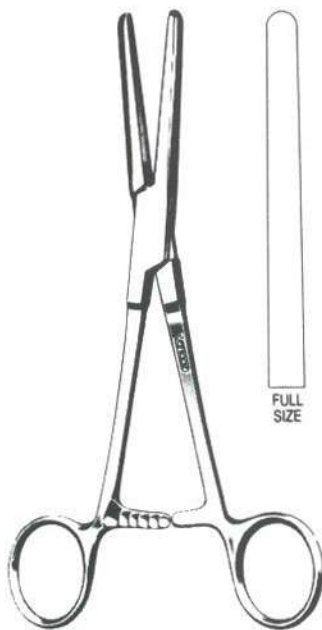

V97-590



FULL
SIZE

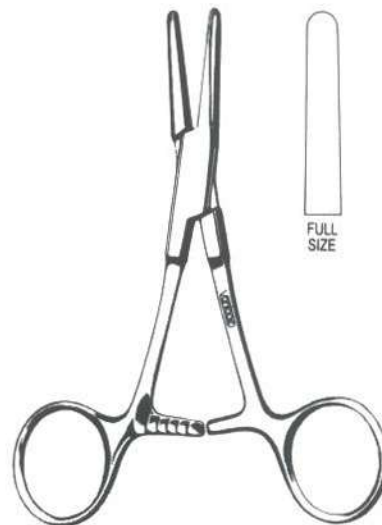

V97-588



FULL
SIZE

3-2000 MILTEX Occlusion Clamp for arteriovenous cannula, 1 3/4" (4.4 cm), cross action

V97-584 ST. VINCENTS Tube Occluding Clamp 6 1/2" (16.5 cm), curved, smooth jaws

V97-590 PRESBYTERIAN HOSPITAL Tube Occluding Clamp 7" (17.8 cm), straight, smooth jaws, heavy pattern

V97-588 English Pattern Tube Occluding Clamp 4 1/2" (11.4 cm), straight, smooth jaws

V97-585 U.S. Pattern Tube Occluding Clamp 5 3/4" (14.6 cm), straight, serrated jaws, with guard

V97-591 U.S. Pattern Tube Occluding Clamp 7 1/2" (19.1 cm), straight, serrated jaws, with guard

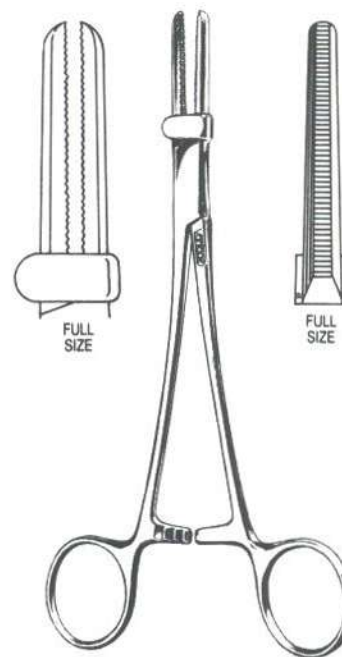

FULL
SIZE

FULL
SIZE

V97-585
V97-591

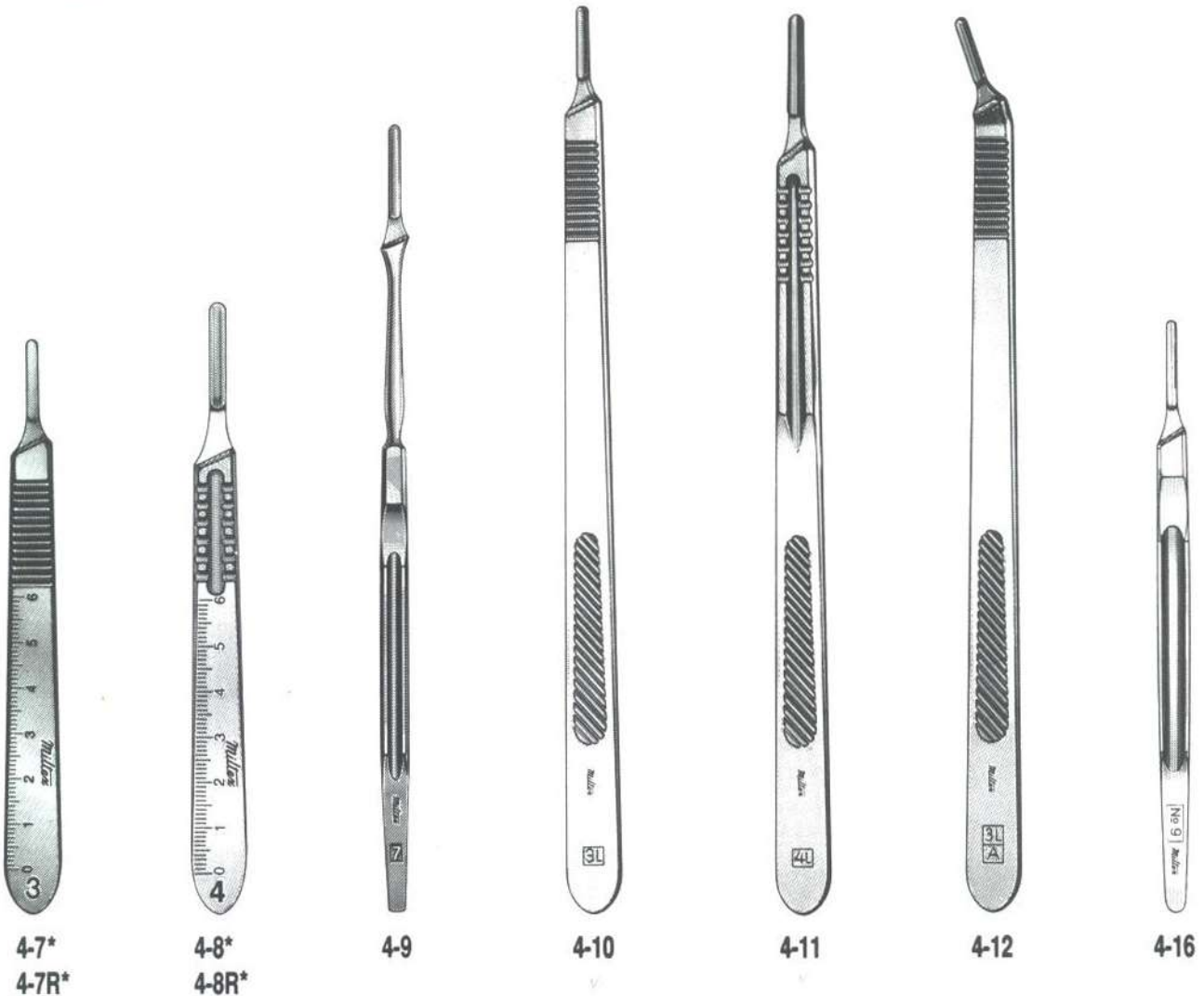

- 4-7 *KNIFE HANDLE No. 3 fitting surgical blades Nos. 10 thru 15, Extra Fine
- 4-7R *Same as No. 4-7, but Economy Grade, Rustless, Nickel Plated
- 4-8 *KNIFE HANDLE No. 4 fitting surgical blades Nos. 20 thru 25, Extra Fine
- 4-8R *Same as No. 4-8, but Economy Grade, Rustless, Nickel Plated
- 4-9 KNIFE HANDLE No. 7, fitting surgical blades Nos. 10 thru 15, Extra Fine
- 4-10 KNIFE HANDLE No. 3L, for deep surgery, fitting blades Nos. 10 thru 15, Extra Fine
- 4-11 KNIFE HANDLE No. 4L, for deep surgery, fitting blades Nos. 20 thru 25, Extra Fine
- 4-12 KNIFE HANDLE No. 3LA, angled tip, for deep surgery, fitting blades Nos. 10 thru 15, Extra Fine
- 4-16 KNIFE HANDLE, No. 9, fitting blades Nos. 10 thru 15, Extra Fine

*Handles have mm and cm graduations



- 4-17** SIEGEL Knife Handle 6" (15.2 cm) round, fitting blades Nos. 10 thru 15
- 4-18** Knife Handle Style No. 5, 5" (12.7 cm), green plastic w/stainless tip, fitting blades Nos. 10 thru 15
- 4-20** Knife Handle Style No. 6, 5¼" (13.3 cm), red plastic w/stainless tip, fitting blades Nos. 20 thru 25
- E-Z-OFF Reusable Plastic Knife Handles (Pat. Pend.), autoclavable, permitting quick and safe removal of blade, box of 10
- 4-30** Style No. 3, fitting blades Nos. 10 thru 15, grey color
- 4-31** Style No. 4, fitting blades Nos. 20 thru 25, blue color
- 4-400** Miniature Blade Handle w/chuck, 3¾" (9.5 cm), round knurled (3K type)
- 4-401** Miniature Blade Handle w/self-locking chuck, 3¾" (9.5 cm), round knurled (3K type)



Sterile Surgical Blades

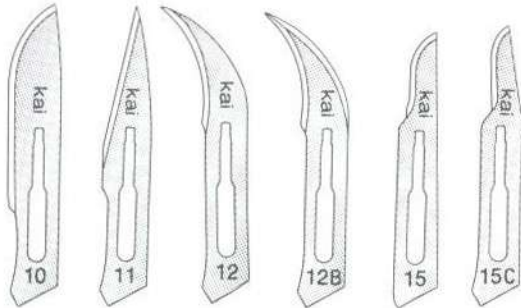

(Fits handles #'s 3, 3L, 3LA, 5, 7, 9, SIEGEL)

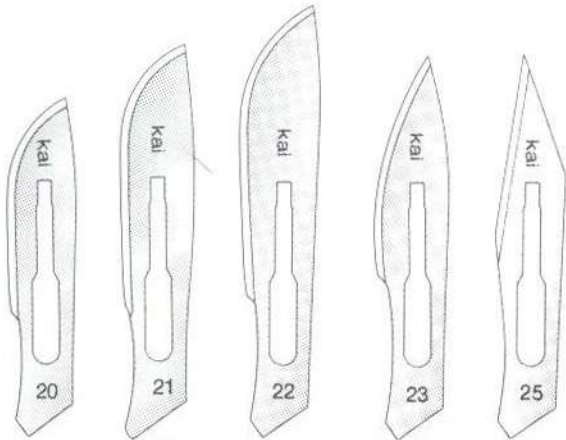

(Fits handles #'s 4, 4L, 6)



4-110 to 4-125

MILTEX SURGICAL BLADES — Made by Kai

Individually sealed in Foil Peel Packs.
Packed 100 blades to a Dispenser Box.
Sterilized by Gamma Radiation 2.5M Rads.

CARBON STEEL — STERILE

	Blade Size
4-110	10
4-111	11
4-112	12
4-112B	12B
4-115	15
4-115C	15C
4-120	20
4-121	21
4-122	22
4-123	23
4-125	25
4-100	

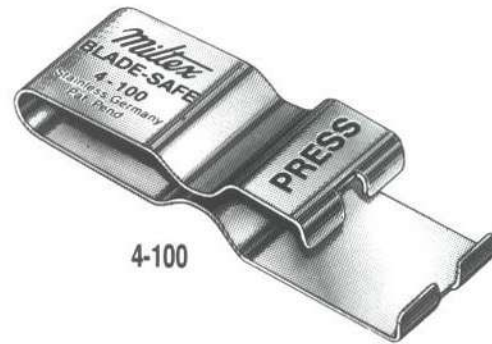

BLADE SAFE Surgical Blade Remover, will remove blades easily and safely from any style surgical handle.

Sterile Surgical Blades

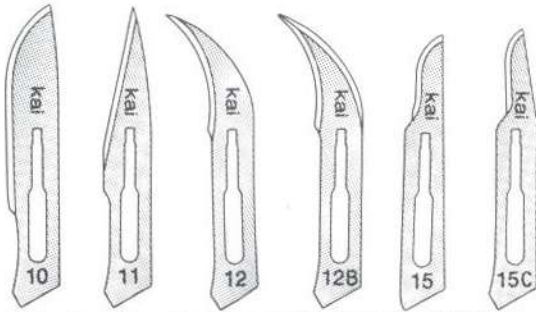

(Fits handles #'s 3, 3L, 3LA, 5, 7, 9, SIEGEL)

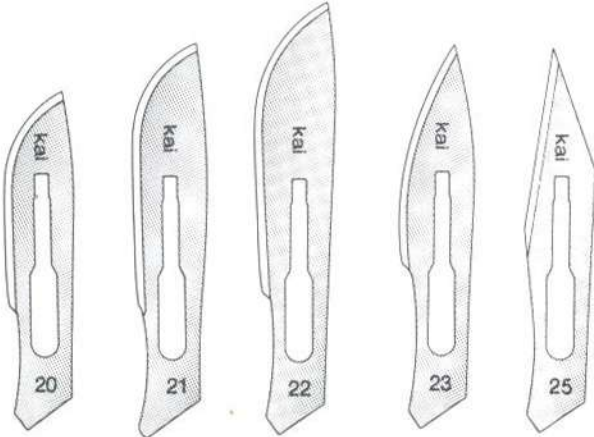

(Fits handles #'s 4, 4L, 6)



4-310 to 4-325

MILTEX SURGICAL BLADES — Made by Kai

Individually sealed in Foil Peel Packs.
Packed 100 blades to a Dispenser Box.
Sterilized by Gamma Radiation 2.5M Rads.

STAINLESS STEEL — STERILE

	Blade Size
4-310	10
4-311	11
4-312	12
4-312B	12B
4-315	15
4-315C	15C
4-320	20
4-321	21
4-322	22
4-323	23
4-325	25



Sterile Disposable Scalpels

Miltex single-use Scalpels are pre-assembled: Stainless steel surgical blades mounted on plastic handles with fluted finger-grips. The scalpel blade is safely protected by a new type easy pull-off protector.

Each sterile scalpel is sealed in a peel-apart see-through package. 10 scalpels are packaged in a handy dispenser box for convenient use. Scalpels are supplied sterile - ready-to-use.

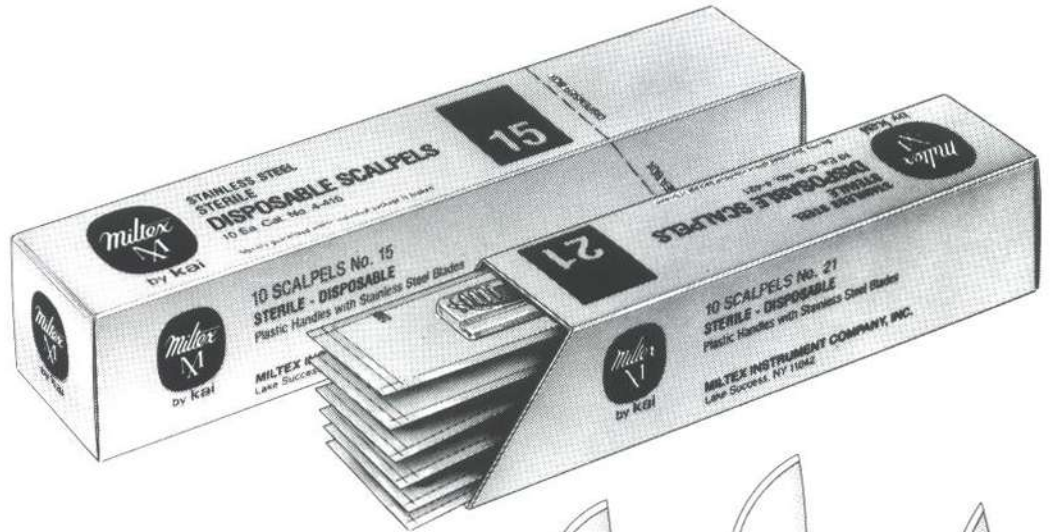

MILTEX DISPOSABLE SCALPELS — Made by Kai

Packed 10 Scalpels to a Dispenser Box.
Sterilized by EO.

STAINLESS STEEL — STERILE

	Blade Size
4-410	10
4-411	11
4-412	12
4-415	15
4-420	20
4-421	21
4-422	22
4-423	23



5-2 to 5-8



5-12 to 5-19



5-22 to 5-28



5-32 to 5-38



5-42 to 5-49



5-52 to 5-58

STANDARD PATTERN OPERATING SCISSORS

Straight

Curved

Straight

Curved

Sharp-sharp points

Sharp-blunt points

5-2	4½" (11.4 cm)	5-32	5-12	4½" (11.4 cm)	5-42
5-4	5" (12.7 cm)	5-34	5-14	5" (12.7 cm)	5-44
5-6	5½" (14 cm)	5-36	5-16	5½" (14 cm)	5-46
5-7	6" (15.2 cm)	5-37	5-17	6" (15.2 cm)	—
5-8	6½" (16.5 cm)	5-38	5-18	6½" (16.5 cm)	5-48
			5-19	7½" (19.1 cm)	5-49

Straight

Curved

Blunt-blunt points

5-22	4½" (11.4 cm)	5-52
5-24	5" (12.7 cm)	5-54
5-26	5½" (14 cm)	5-56
5-27	6" (15.2 cm)	—
5-28	6½" (16.5 cm)	5-58



5-70 to 5-73



5-74 to 5-77



5-60 to 5-62
5-80 to 5-84

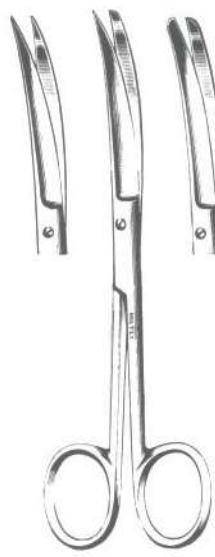

5-63 to 5-65
5-86 to 5-90



5-100 to 5-104



5-106 to 5-108

SERRATEX OPERATING SCISSORS

Standard Pattern Operating Scissors. One blade with fine serrations reduces tissue slippage.

Straight		Curved
5-70	5½" (14 cm) Sharp-sharp points	5-74
5-72	5½" (14 cm) Sharp-blunt points	5-76
5-73	5½" (14 cm) Blunt-blunt points	5-77

NOTE: Serrated blades are available on all types of scissors, on special request.

LIGHTWEIGHT OPERATING SCISSORS

Delicate pattern designed for pediatric, vascular and other delicate procedures.

Straight		Curved
Sharp-sharp points		
5-60	5" (12.7 cm)	5-63
5-80	5½" (14 cm)	5-86
Sharp-blunt points		
5-61	5" (12.7 cm)	5-64
5-82	5½" (14 cm)	5-88
Blunt-blunt points		
5-62	5" (12.7 cm)	5-65
5-84	5½" (14 cm)	5-90

DEAVER SCISSORS 5½" (14 cm)

5-100	Straight, sharp-sharp points	5-106	Curved, sharp-sharp points
5-102	Straight, sharp-blunt points	5-108	Curved, sharp-blunt points
5-104	Straight, blunt-blunt points		



5-112



5-114



5-115
5-116



5-120
5-124



5-122
5-126

- 5-112 MIXTER Scissors 6¼" (15.9 cm), straight, blunt points
- 5-114 MIXTER Scissors 6¼" (15.9 cm), curved, blunt points
- 5-115 MAYO Operating Scissors 5½" (14 cm), straight, heavy pattern, sharp points
- 5-116 MAYO Operating Scissors 5½" (14 cm), curved, heavy pattern, sharp points
- 5-120 MAYO Dissecting Scissors 5½" (14 cm), straight, standard beveled blades
- 5-122 MAYO Dissecting Scissors 5½" (14 cm), curved, standard beveled blades
- 5-124 MAYO Dissecting Scissors 6¾" (17.1 cm), straight, standard beveled blades
- 5-126 MAYO Dissecting Scissors 6¾" (17.1 cm), curved, standard beveled blades
- 5-128 MAYO Dissecting Scissors 9" (22.9 cm), straight, standard beveled blades
- 5-130 MAYO Dissecting Scissors 9" (22.9 cm), curved, standard beveled blades

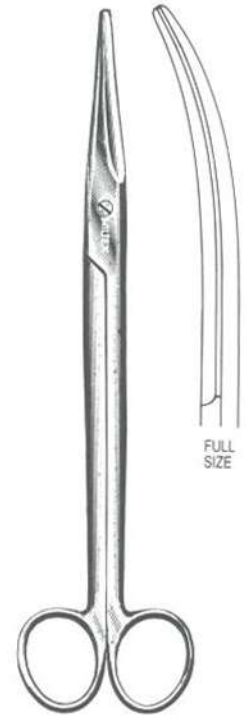

5-128
5-130



5-132



5-134



5-136
5-140



5-138
5-142

- 5-132 SERRATEX-MAYO Dissecting Scissors 6 $\frac{3}{4}$ " (17.1 cm), straight, one fine serrated blade
- 5-134 SERRATEX-MAYO Dissecting Scissors 6 $\frac{3}{4}$ " (17.1 cm), curved, one fine serrated blade
- 5-136 MAYO Dissecting Scissors 5 $\frac{1}{2}$ " (14 cm), straight, rounded blades
- 5-138 MAYO Dissecting Scissors 5 $\frac{1}{2}$ " (14 cm), curved, rounded blades
- 5-140 MAYO Dissecting Scissors 6 $\frac{3}{4}$ " (17.1 cm), straight, rounded blades
- 5-142 MAYO Dissecting Scissors 6 $\frac{3}{4}$ " (17.1 cm), curved, rounded blades



5-144



5-146



5-148

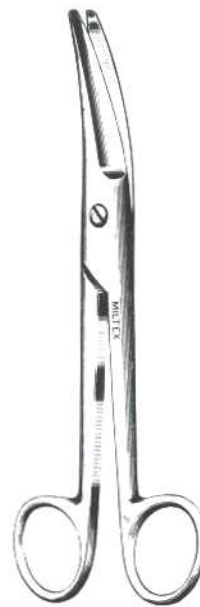

5-150



5-152
5-154

- 5-144 MAYO-NOBLE Dissecting Scissors 6½" (16.5 cm), straight, rounded blades
- 5-146 MAYO-NOBLE Dissecting Scissors 6½" (16.5 cm), curved, rounded blades
- 5-148 MAYO-NOBLE Dissecting Scissors 6½" (16.5 cm), straight, beveled blades
- 5-150 MAYO-NOBLE Dissecting Scissors 6½" (16.5 cm), curved, beveled blades
- 5-152 SISTRUNK Scissors 5½" (14 cm), straight
- 5-154 SISTRUNK Scissors 5½" (14 cm), slightly curved

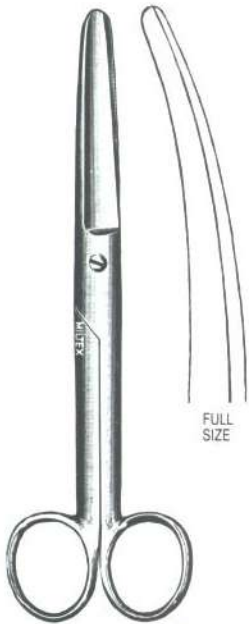

5-160
5-162



5-166



5-172 to 5-178



30-2190
30-2195



30-2575

- 5-160** DOYEN Abdominal Scissors 7" (17.8 cm), straight
- 5-162** DOYEN Abdominal Scissors 7" (17.8 cm), curved
- 5-166** FERGUSON Abdominal Scissors 7" (17.8 cm), angled on flat
- 5-172** REYNOLDS Dissecting Scissors 6" (15.2 cm), curved, tenotomy type dissecting tips
- 5-174** REYNOLDS Dissecting Scissors 6" (15.2 cm), curved, tenotomy type dissecting tips, one serrated blade
- 5-176** REYNOLDS Dissecting Scissors 7" (17.8 cm), curved, tenotomy type dissecting tips
- 5-178** REYNOLDS Dissecting Scissors 7" (17.8 cm), curved, tenotomy type dissecting tips, one serrated blade
- 30-2190** BRAUN Episiotomy Scissors 5½" (14 cm), angled to side, guarded lower blade
- 30-2195** BRAUN Episiotomy Scissors 8½" (21.6 cm), angled to side, guarded lower blade
- 30-2575** Umbilical Scissors 4⅞" (10.5 cm), American Pattern
- 30-2580** BUSCH Scissors 6½" (16.5 cm), curved on side



30-2580



5-180
5-182
5-184



5-188
5-192
5-196



5-284
5-286
5-288



5-185
5-189
5-193



5-200
5-202

METZENBAUM SCISSORS – STANDARD PATTERN

Straight	Length	Curved
5-179	5½" (14 cm) (Lahey)	5-180
5-181	7" (17.8 cm)	5-182
—	8" (20.3 cm)	5-184
5-186	9" (22.9 cm) (Nelson)	5-188
5-190	11" (27.9 cm) (Nelson)	5-192
5-194	14½" (36.8 cm) (Nelson)	5-196

METZENBAUM SCISSORS – DELICATE PATTERN

Straight	Length	Curved
5-283	5" (12.7 cm)	5-284
—	6" (15.2 cm)	5-286
—	7" (17.8 cm)	5-288
5-183	8" (20.3 cm)	5-185
5-187	9" (22.9 cm)	5-189
—	11" (27.9 cm)	5-193

5-200 HARRINGTON Scissors 11½" (29.2 cm), straight
5-202 HARRINGTON Scissors 11½" (29.2 cm), curved



5-220
5-222
5-224



5-226
5-228
5-230



5-243



5-244
5-245

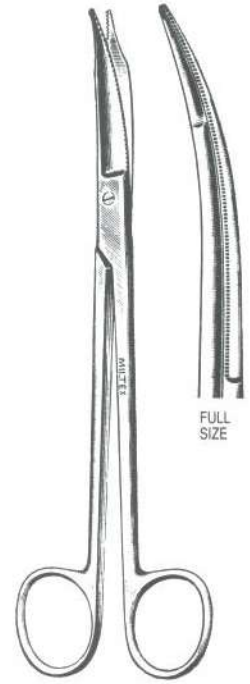

27-1000

- 5-220 SIMS Scissors 8" (20.3 cm), straight, sharp-sharp points
- 5-222 SIMS Scissors 8" (20.3 cm), straight, sharp-blunt points
- 5-224 SIMS Scissors 8" (20.3 cm), straight, blunt-blunt points
- 5-226 SIMS Scissors 8" (20.3 cm), curved, sharp-sharp points
- 5-228 SIMS Scissors 8" (20.3 cm), curved, sharp-blunt points
- 5-230 SIMS Scissors 8" (20.3 cm), curved, blunt-blunt points
- 5-243 JORGENSEN Scissors 9" (22.9 cm), strongly curved blades
- 5-244 THOREK Scissors 7 1/4" (18.4 cm), full curve
- 5-245 THOREK Scissors 10" (25.4 cm), full curve
- 27-1000 MARTIN Cartilage Scissors 8" (20.3 cm), serrated non-slip cutting edges
- 30-2605 DUBOIS Scissors 10 1/2" (26.7 cm), curved, extra heavy pattern, blunt points

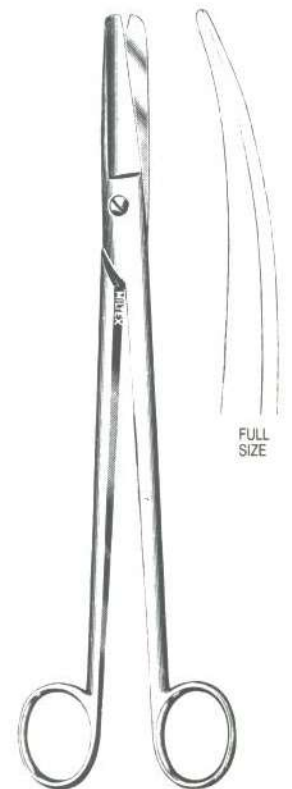

30-2605



5-246
FULL
SIZE

5-247
FULL
SIZE

5-248
FULL
SIZE



5-249A
FULL
SIZE

5-249B
FULL
SIZE

5-249C
FULL
SIZE

- 5-246** POTTIS-SMITH Scissors 7½" (19.1 cm), angled on side 25°, 20 mm blades
- 5-247** POTTIS-SMITH Scissors 7½" (19.1 cm), angled on side 45°, 20 mm blades
- 5-248** POTTIS-SMITH Scissors 7½" (19.1 cm), angled on side 60°, 20 mm blades
- 5-249A** POTTIS-SMITH Scissors 7" (17.8 cm), delicate, angled on side 25°, 13 mm blades
- 5-249B** POTTIS-SMITH Scissors 7" (17.8 cm), delicate, angled on side 45°, 13 mm blades
- 5-249C** POTTIS-SMITH Scissors 7" (17.8 cm), delicate, angled on side 60°, 13 mm blades
- 25-1240B** DeBAKEY-POTTIS Scissors 6¾" (17.1 cm), dull tips, angled on side 45°
- 25-1240C** DeBAKEY-POTTIS Scissors 6¾" (17.1 cm), dull tips, angled on side 60°



25-1240B
FULL
SIZE

25-1240C
FULL
SIZE



25-1280



28-240



5-250
5D-251



5-252
5D-253



5-254
5D-255



5D-328

- 25-1280** SATINSKY Scissors 10" (25.4 cm), S-curved
- 28-240** MILLER Rectal Scissors 6 $\frac{3}{4}$ " (17.1 cm), bayonet shape, delicate serrated blades with blunt points
- 5-250** KELLY Fistula Scissors 6 $\frac{1}{4}$ " (15.9 cm), sharp points, straight
- 5D-251** KELLY Fistula Scissors 6 $\frac{1}{4}$ " (15.9 cm), sharp points, straight, with one serrated blade
- 5-252** KELLY Fistula Scissors 6 $\frac{1}{4}$ " (15.9 cm), sharp points, curved
- 5D-253** KELLY Fistula Scissors 6 $\frac{1}{4}$ " (15.9 cm), sharp points, curved, with one serrated blade
- 5-254** KELLY Fistula Scissors 6 $\frac{1}{4}$ " (15.9 cm), sharp points, angled on side
- 5D-255** KELLY Fistula Scissors 6 $\frac{1}{4}$ " (15.9 cm), sharp points, angular, with one serrated blade
- 5D-328** LOCKLIN Scissors 6 $\frac{1}{4}$ " (15.9 cm), angled on side 25°, with one serrated blade
- 5D-329** LOCKLIN Scissors 6 $\frac{1}{4}$ " (15.9 cm), curved shanks, angled on side 25°, with one serrated blade



5D-329

Operating Scissors



- 5-256** BOETTCHER Dissecting Scissors 7¼" (18.4 cm), double edged, curved
- 22-962** LILLY Dissecting Scissors 7½" (19.1 cm), strong curve
- 5-260** SWEET Scissors 8½" (21.6 cm), angled on flat
- 5-262** STRULLY Dissecting Scissors 8" (20.3 cm), slightly curved blades with probe tips
- 5-264** DEAN Dissecting Scissors 6¾" (17.1 cm), blades angled on flat, one serrated blade
- 5-265** KAHN Dissecting Scissors 5½" (14 cm), straight
- 5-266** KAHN Dissecting Scissors 5½" (14 cm), curved
- 5-267** KAHN Dissecting Scissors 7" (17.8 cm), straight
- 5-268** KAHN Dissecting Scissors 7" (17.8 cm), curved





5-270
5-271



5-272
5-273

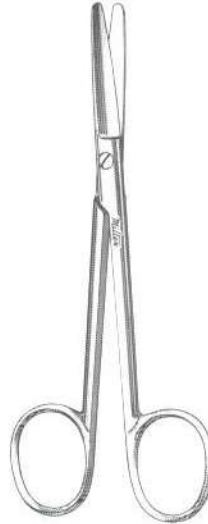

5-274
5-275



5-276
5-277

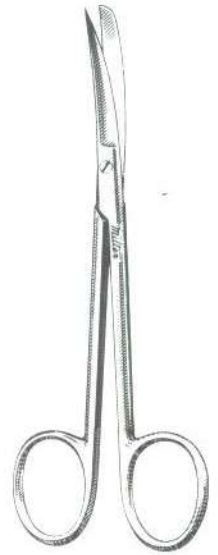

5-278
5-279

PLASTIC SURGERY SCISSORS 4¾" (12.1cm)

Straight

- 5-270 Sharp-sharp points
- 5-271 Sharp-sharp points, serrated blade
- 5-272 Sharp-blunt points
- 5-273 Sharp-blunt points, serrated blade
- 5-274 Blunt-blunt points
- 5-275 Blunt-blunt points, serrated blade

Curved

- 5-276
- 5-277
- 5-278
- 5-279
- 5-280
- 5-281

Angled on side

- 5-282 Sharp-sharp points
- 5-282A Sharp-sharp points, serrated blade



5-280
5-281



5-282
5-282A

Operating Scissors



5-290
5-291



5-300



5-302



5D-303



5-304

5-290 RAGNELL Dissecting Scissors 5" (12.7 cm), flat tip, curved

5-291 RAGNELL Dissecting Scissors 7" (17.8 cm), flat tip, curved

5-300 Iris Scissors 4" (10.2 cm), straight

5-302 Iris Scissors 4" (10.2 cm), curved

5D-303 Iris Scissors 4½" (11.4 cm), curved sideways

5-304 Iris Scissors 4½" (11.4 cm), straight

5-306 Iris Scissors 4½" (11.4 cm), curved

5-308 Iris Scissors 4½" (11.4 cm), angled on side



5-306



5-308



- 18-1392** BONN Miniature Iris Scissors 3½" (8.9 cm), with 15 mm blades, straight
- 18-1394** BONN Miniature Iris Scissors 3½" (8.9 cm), with 15 mm blades, curved
- 18-1396** Iris Scissors 3½" (8.9 cm), with 20 mm blades, straight, delicate
- 18-1398** Iris Scissors 3½" (8.9 cm), with 20 mm blades, curved, delicate
- 18-1404** MILTEX Iris Scissors 4" (10.2 cm), straight, heavy pattern
- 18-1405** MILTEX Iris Scissors 4" (10.2 cm), curved, heavy pattern
- 18-1415*** Iris Scissors 4" (10.2 cm), straight, standard pattern, ribbon type
- 18-1416*** Iris Scissors 4" (10.2 cm), curved, standard pattern, ribbon type
- 18-1417*** Iris Scissors 3¾" (9.5 cm), straight, miniature pattern with 14 mm blades, ribbon type
- 18-1418*** Iris Scissors 3¾" (9.5 cm), curved, miniature pattern with 14 mm blades, ribbon type
- 18-1419*** Utility Scissors 3¾" (9.5 cm), curved blunt blades, 15 mm long, ribbon type



*Ribbon Type Scissors have extra large finger rings; shanks and rings have satin finish; blades are highly polished

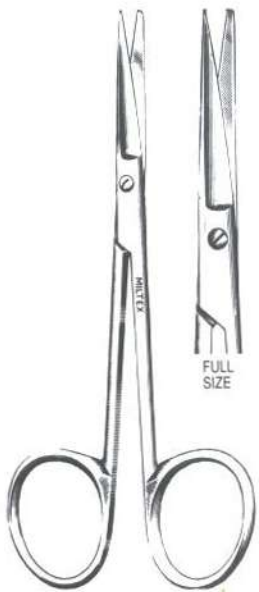

18-1420
18-1422



18-1426
18-1428



18-1440



18-1510
18-1512
18-1514



18-1516

- 18-1420 KNAPP Iris Scissors 4" (10.2 cm), straight, sharp-blunt points
- 18-1422 KNAPP Iris Scissors 4" (10.2 cm), straight, blunt-blunt points
- 18-1426 KNAPP Iris Scissors 4" (10.2 cm), curved, sharp-blunt points
- 18-1428 KNAPP Iris Scissors 4" (10.2 cm), curved, blunt-blunt points
- 18-1440 WILMER Conjunctival and Utility Scissors 4" (10.2 cm), angled on flat

- 18-1510 NOYES Iris Scissors 4½" (11.4 cm), straight, sharp-sharp points
- 18-1512 NOYES Iris Scissors 4½" (11.4 cm), straight, sharp-blunt points
- 18-1514 NOYES Iris Scissors 4½" (11.4 cm), straight, blunt-blunt points
- 18-1516 NOYES Iris Scissors 4½" (11.4 cm), curved, sharp-sharp points

- 18-1520 BARRAQUER Iris Scissors 2¼" (5.7cm), angled 7 mm blades, sharp points
- 18-1521 BARRAQUER Iris Scissors 2¼" (5.7cm), angled 7 mm blades, blunt points

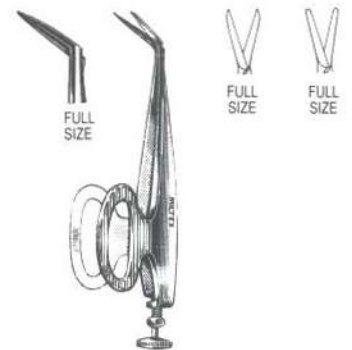

18-1520
18-1521

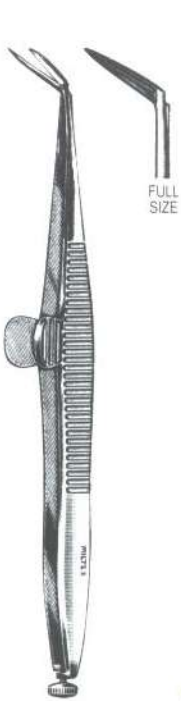

18-1524
18-1526



18-1550
18-1552



18-1554

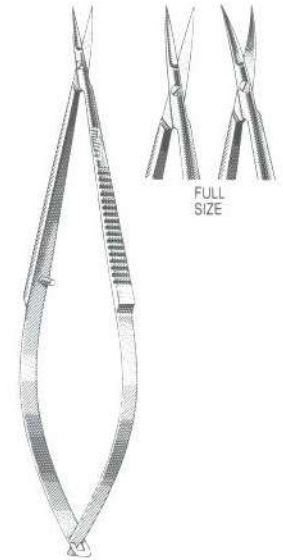

18-1618
18-1619

18-1524 DeWECKER Iris Scissors 4¼" (10.8 cm), angled 7 mm blades, sharp-sharp points
18-1526 DeWECKER Iris Scissors 4¼" (10.8 cm), angled 7 mm blades, sharp-blunt points

18-1550 McCCLURE Iris Scissors 3¾" (9.5 cm), angled over edge, 4 mm blades with very delicate sharp points

18-1552 McCCLURE Iris Scissors 3¾" (9.5 cm), angled on flat, 4 mm blades with very delicate sharp points

18-1554 McCCLURE Iris Scissors 4" (10.2 cm), angled on flat, regular 10 mm blades with sharp points

18-1618 Micro Iris Scissors 4" (10.2 cm), straight, sharp points

18-1619 Micro Iris Scissors 4" (10.2 cm), curved, sharp points

18-1625 McPHERSON-VANNAS Micro Iris Scissors 3¼" (8.3 cm), straight, sharp points

18-1626 McPHERSON-VANNAS Micro Iris Scissors 3¼" (8.3 cm), curved, sharp points



18-1625
18-1626



18-1430



18-1432



5-310



5-312



5-314

- 18-1430** Eye Scissors with probe points 4" (10.2 cm), straight
- 18-1432** Eye Scissors with probe points 4" (10.2 cm), curved
- 5-310** Eye Scissors with probe points 4½" (11.4 cm), angled on side
- 5-312** Strabismus Scissors 4" (10.2 cm), straight
- 5-314** Strabismus Scissors 4" (10.2 cm), curved
- 18-1453*** Strabismus Scissors 4¼" (10.8 cm), curved, ribbon type
- 18-1454*** Strabismus Scissors 4¼" (10.8 cm), curved, ribbon type



18-1453*
18-1454*

*Ribbon Type Scissors have extra large finger rings; shanks and rings have satin finish; blades are highly polished



5-316



5-318



5D-326



5-320

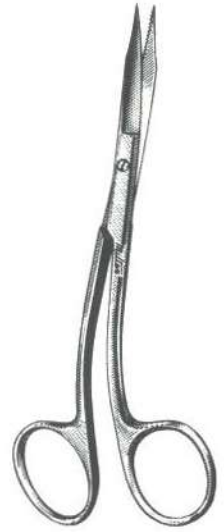

5D-322

- 5-316 BROPHY Scissors 5½" (14 cm), straight, sharp points
- 5-318 BROPHY Scissors 5½" (14 cm), curved, sharp points
- 5D-326 BROPHY Scissors 5½" (14 cm), curved, one serrated blade
- 5-320 GOLDMAN-FOX Wound Debridement Scissors 5" (12.7 cm), curved fine tips with one serrated blade
- 5D-322 GOLDMAN-FOX Wound Debridement Scissors 5" (12.7 cm), curved, one serrated blade, angled shanks
- 5D-324 LA GRANGE Scissors 4¼" (10.8 cm), curved, one serrated blade, angled shanks
- 21-539 KLEINERT-KUTZ Tenotomy Scissors 4⅞" (12.4 cm), curved, rounded dissecting blades



5D-324



21-539



21-558
21D-559



21-560



21-600



21-602



21-604

21-558 QUIMBY Scissors 5" (12.7 cm), blades 15 mm, strongly curved and pointed
21D-559 QUIMBY Scissors 5" (12.7 cm), blades 15 mm, strongly curved and pointed, one serrated blade

21-560 TAYLOR Dural Scissors 5½" (14 cm), with probe tip

21-600 FOMON Saber-Back 5" (12.7 cm), slightly curved blades with semi-sharp outer edges used for dissection

21-602 FOMON Lower Lateral Scissors 5" (12.7 cm), strong curve, dissecting blades

21-604 FOMON Dorsal Scissors 5½" (14 cm), light pattern, angular shanks

21-605 MILTEX Saber-Back Rhytidectomy Scissors 6½" (16.5 cm), curved with semi-sharp outer edges used for dissection



21-605



- 21-606** CASTANARES Facelift Scissors 6¼" (15.9 cm), straight, short strong blades
- 21-607** GORNEY Facelift Scissors 7¾" (19.7 cm), straight, one serrated blade
- 21-608** GORNEY Facelift Scissors 7¾" (19.7 cm), slightly curved, one serrated blade
- 21-610** COTTLE Dorsal Scissors 6½" (16.5 cm), heavy pattern with rounded blades, angular shanks
- 21-612** COTTLE Bulldog Nasal Scissors 4½" (11.4 cm), slightly curved blunt blades



21-621



21-622



21-630
21-632



33-240

- 21-621 GORNEY Septal Scissors 7¾" (19.7 cm), double action, angled handle, serrated blades with 1¾" (4.4 cm) cut
- 21-622 CAPLAN Nasal Bone Scissors 8" (20.3 cm), double action, serrated blades
- 21-630 JOSEPH Nasal Scissors 5¾" (14.6 cm), straight, sharp points
- 21-632 JOSEPH Nasal Scissors 5¾" (14.6 cm), curved, sharp points
- 33-240 BIRO Dermal Naevus Scissors 4" (10.2 cm), angled on flat, with sharp outside edges
- 33-242 MILTEX Undermining Scissors 4½" (11.4 cm), curved blades, with flat pointed tip



33-242



9-96



9-98

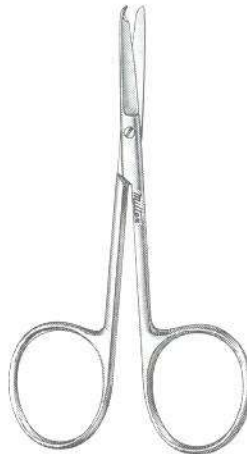

9-100



9-101

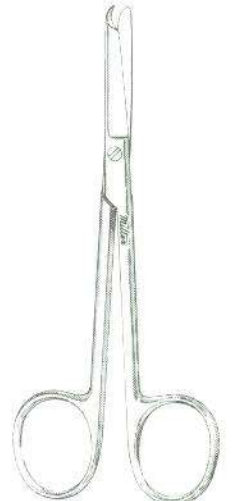

9-102

- 9-96 HEATH Suture Scissors 6¼" (15.9 cm), serrated blade
- 9-98 NEW'S Suture Scissors 5½" (14 cm), angled on flat
- 9-100 SPENCER Stitch Scissors 3½" (8.9 cm), delicate
- 9-101 SHORTBENT Stitch Scissors 3½" (8.9 cm), curved, delicate
- 9-102 LITTAUER JR. Stitch Scissors 4½" (11.4 cm), light pattern
- 9-103 NORTHBENT Stitch Scissors 4¾" (12.1 cm), curved, light pattern
- 9-104 LITTAUER Stitch Scissors 5½" (14 cm), standard pattern



9-103

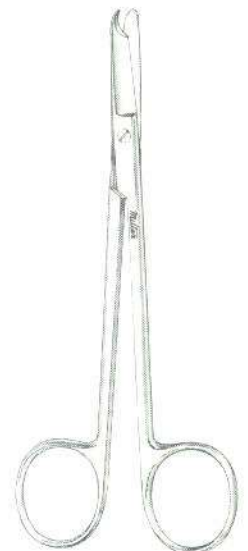

9-104

Operating Scissors



9-106



9-108

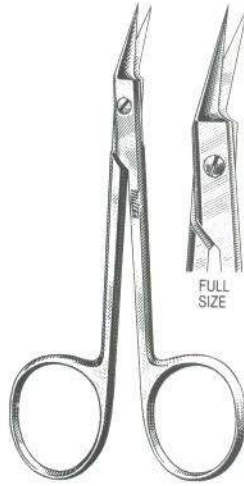

9-110



9-120
9D-121

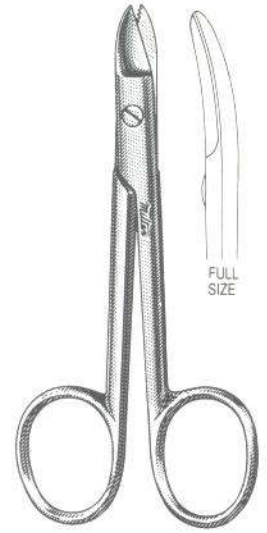

9-122
9D-123

- 9-106 LONG Oral Surgery Stitch Scissors 6" (15.2 cm)
- 9-108 MILTEX Stitch Scissors 4½" (11.4 cm), angled, delicate
- 9-110 O'BRIEN Stitch Scissors 3¾" (9.5 cm), angled, sharp points
- WIRE CUTTING SCISSORS 4¾" (12.1 cm)
- 9-120 Straight, one serrated blade
- 9D-121 Straight
- 9-122 Curved, one serrated blade
- 9D-123 Curved
- 9-124 Angled to side, one serrated blade



9-124

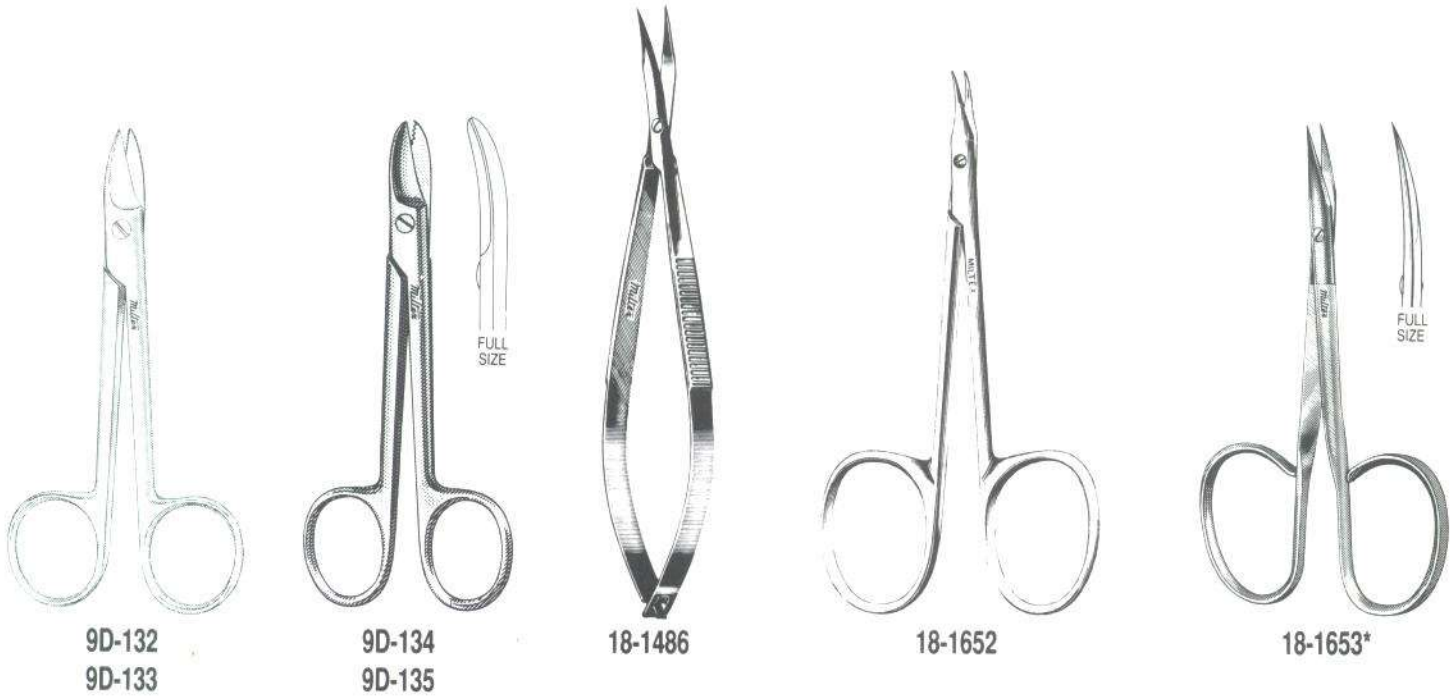

WIRE CUTTING SCISSORS 4¼" (10.8 cm)

- 9D-132** Straight, one serrated blade
- 9D-133** Straight
- 9D-134** Curved, one serrated blade
- 9D-135** Curved

18-1486 WESTCOTT Stitch Scissors 4½" (11.4 cm), curved, sharp points

18-1652 Eye Suture (GRADLE) Scissors ¾" (9.5 cm), slightly curved, sharp points

18-1653* Eye Suture Scissors 4" (10.2 cm), slightly curved, sharp points, ribbon type

21-536 LITTLER Suture Carrying Scissors ⅝" (11.8 cm), with suture hole in blades, curved



21-536

* Ribbon Type Scissors have extra large finger rings; shanks and rings have satin finish; blades are highly polished



17-115
17-120
17-215



FULL
SIZE

17-115
17-215



FULL
SIZE

17-120



17-500

PENCIL-TYPE MICRO SCISSORS

7¼" (18.4 cm) overall length; extremely delicate working ends

- 17-115 Scissors, 4 mm long blades, straight shaft
- 17-120 Scissors, 8 mm long blades, straight shaft
- 17-215 Scissors, 4 mm long blades, angled shaft

- 17-500 MILTEX Micro Dissecting Scissors 5¼" (14.6 cm), double action, sharp points, spring handle



17-2060
17-2040



17-2150
17-2100



17-2160
17-2110



18-1558
18-1559

MILTEX MICRO SURGERY SCISSORS, Sharp points

- 17-2060 6" (15.2 cm) straight, 8 mm blades, flat handles
- 17-2040 6" (15.2 cm) curved, 8 mm blades, flat handles
- 17-2150 6" (15.2 cm) straight, 6 mm blades, round handles
- 17-2100 6" (15.2 cm) curved, 6 mm blades, round handles
- 17-2160 7½" (18.1 cm) straight, 6 mm blades, round handles
- 17-2110 7½" (18.1 cm) curved, 6 mm blades, round handles

- 18-1558 CASTROVIEJO Corneal Scissors 4" (10.2 cm), right, sub-miniature for micro surgery, 6 mm blades
- 18-1559 CASTROVIEJO Corneal Scissors 4" (10.2 cm), left, sub-miniature for micro surgery, 6 mm blades

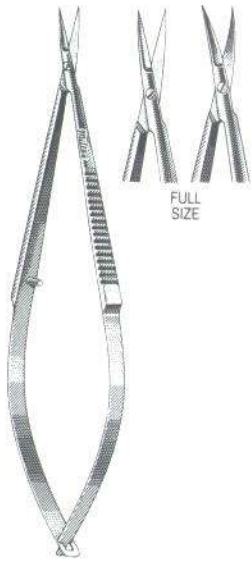

18-1618
18-1619



18-1625
18-1626

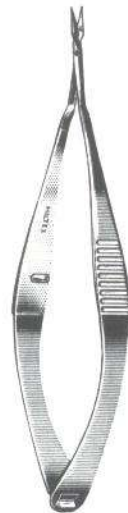

18-1630
18-1631



18-1633
18-1634



- 18-1618 Micro Iris Scissors 4" (10.2 cm), straight, sharp points
- 18-1619 Micro Iris Scissors 4" (10.2 cm), curved, sharp points
- 18-1625 McPHERSON-VANNAS Micro Iris Scissors 3/4" (8.3 cm), straight, sharp points
- 18-1626 McPHERSON-VANNAS Micro Iris Scissors 3/4" (8.3 cm), curved, sharp points
- 18-1630 Micro-VANNAS Scissors 3/4" (8.3 cm), straight, ultrafine blades
- 18-1631 Micro-VANNAS Scissors 3/4" (8.3 cm), curved, ultrafine blades
- 18-1633 Micro Scissors 3/4" (8.3 cm), straight, superfine blades
- 18-1634 Micro Scissors 3/4" (8.3 cm), curved, superfine blades



18-1460 to 18-1476

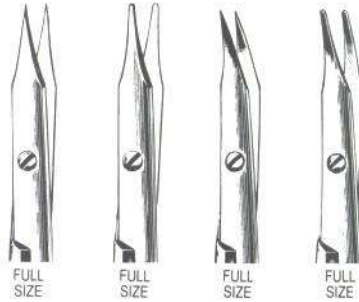

18-1460 to 18-1466

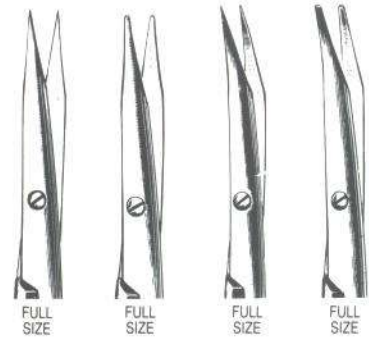

18-1470 to 18-1476

STEVENS TENOTOMY SCISSORS

- 18-1460 Straight sharp points 4 $\frac{1}{8}$ " (10.5 cm), short blades
- 18-1462 Straight blunt points 4 $\frac{1}{8}$ " (10.5 cm), short blades
- 18-1464 Curved sharp points 4 $\frac{1}{8}$ " (10.5 cm), short blades
- 18-1466 Curved blunt points 4 $\frac{1}{8}$ " (10.5 cm), short blades
- 18-1470 Straight sharp points 4 $\frac{1}{2}$ " (11.4 cm), long blades
- 18-1472 Straight blunt points 4 $\frac{1}{2}$ " (11.4 cm), long blades
- 18-1474 Curved sharp points 4 $\frac{1}{2}$ " (11.4 cm), long blades
- 18-1476 Curved blunt points 4 $\frac{1}{2}$ " (11.4 cm), long blades
- 18-1477* STEVENS Tenotomy Scissors 3 $\frac{3}{4}$ " (9.5 cm), straight, blunt points, ribbon type
- 18-1478* STEVENS Tenotomy Scissors 3 $\frac{3}{4}$ " (9.5 cm), curved, blunt points, ribbon type

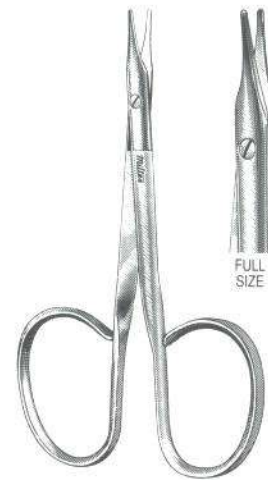

18-1477*
18-1478*

*Ribbon Type Scissors have extra large finger rings; shanks and rings have satin finish; blades are highly polished



18-1480



18-1482



18-1484



18-1487
18-1488

FULL
SIZE

- 18-1480 WESTCOTT Utility Scissors 4½" (11.4 cm), curved, blunt tips
- 18-1482 SCHEIE-WESTCOTT Corneal Section Scissors 5" (12.7 cm), right, curved, blunt tips
- 18-1484 SCHEIE-WESTCOTT Corneal Section Scissors 5" (12.7 cm), left, curved, blunt tips
- 18-1487 WESTCOTT Tenotomy Scissors 5¼" (13.3 cm), right, wide handles
- 18-1488 WESTCOTT Tenotomy Scissors 5¼" (13.3 cm), left, wide handles
- 18-1494 Enucleation Scissors 5" (12.7 cm), light curve
- 18-1496 Enucleation Scissors 5" (12.7 cm), medium curve
- 18-1498 Enucleation Scissors 5" (12.7 cm), full curve



18-1494 to 18-1498

FULL
SIZE



18-1540



18-1560



18-1562

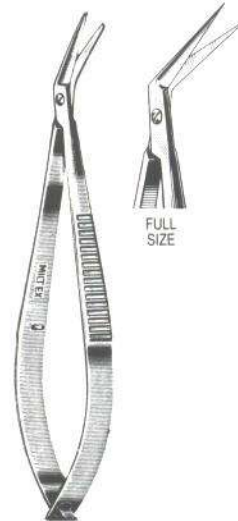

18-1570
18-1572



18-1576



18-1578

- 18-1540 NOYES Iridectomy Scissors 5½" (14 cm), straight, 7 mm blades, sharp-sharp points
- 18-1560 CASTROVIEJO Corneal Section Scissors 4½" (11.4 cm), right, inner blade 1 mm longer, blunt tips
- 18-1562 CASTROVIEJO Corneal Section Scissors 4½" (11.4 cm), left, inner blade 1 mm longer, blunt tips
- 18-1570 CASTROVIEJO Keratoplasty Scissors 3¾" (9.5 cm), angled blades 11 mm, sharp points
- 18-1572 CASTROVIEJO Corneal Scissors 3¾" (9.5 cm), angled blades 11 mm, blunt points
- 18-1576 CASTROVIEJO Corneal Scissors 3¾" (9.5 cm), curved, sharp points
- 18-1578 CASTROVIEJO Corneal Scissors 3¾" (9.5 cm), curved, blunt points
- 18-1594 McGUIRE Corneal Scissors 4⅛" (10.5 cm), right
- 18-1596 McGUIRE Corneal Scissors 4⅛" (10.5 cm), left



18-1594
18-1596

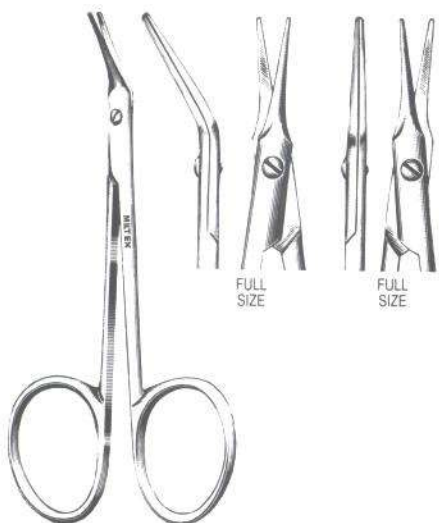

18-1600 to 18-1604



18-1620
18-1622

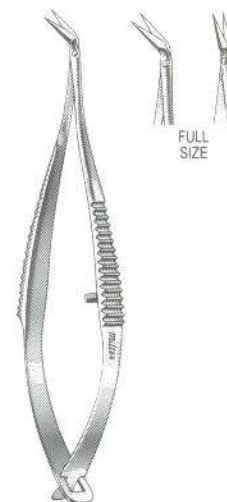

18-1623
18-1624

- 18-1600 AEBLI Corneal Scissors 4" (10.2 cm), straight
- 18-1602 AEBLI Corneal Scissors 4" (10.2 cm), angled on flat, right
- 18-1604 AEBLI Corneal Scissors 4" (10.2 cm), angled on flat, left
- 18-1620 VANNAS Capsulotomy Scissors 3¼" (8.3cm), straight, very delicate sharp points
- 18-1622 VANNAS Capsulotomy Scissors 3¼" (8.3 cm), curved, very delicate sharp points
- 18-1623 VANNAS Capsulotomy Scissors 3¼" (8.3 cm), angled to side, very delicate sharp points
- 18-1624 VANNAS Capsulotomy Scissors 3¼" (8.3 cm), angled on flat, very delicate sharp points
- 19-2060 WULLSTEIN Ear Scissors 3" (7.6 cm) shaft, straight, very delicate



19-2060

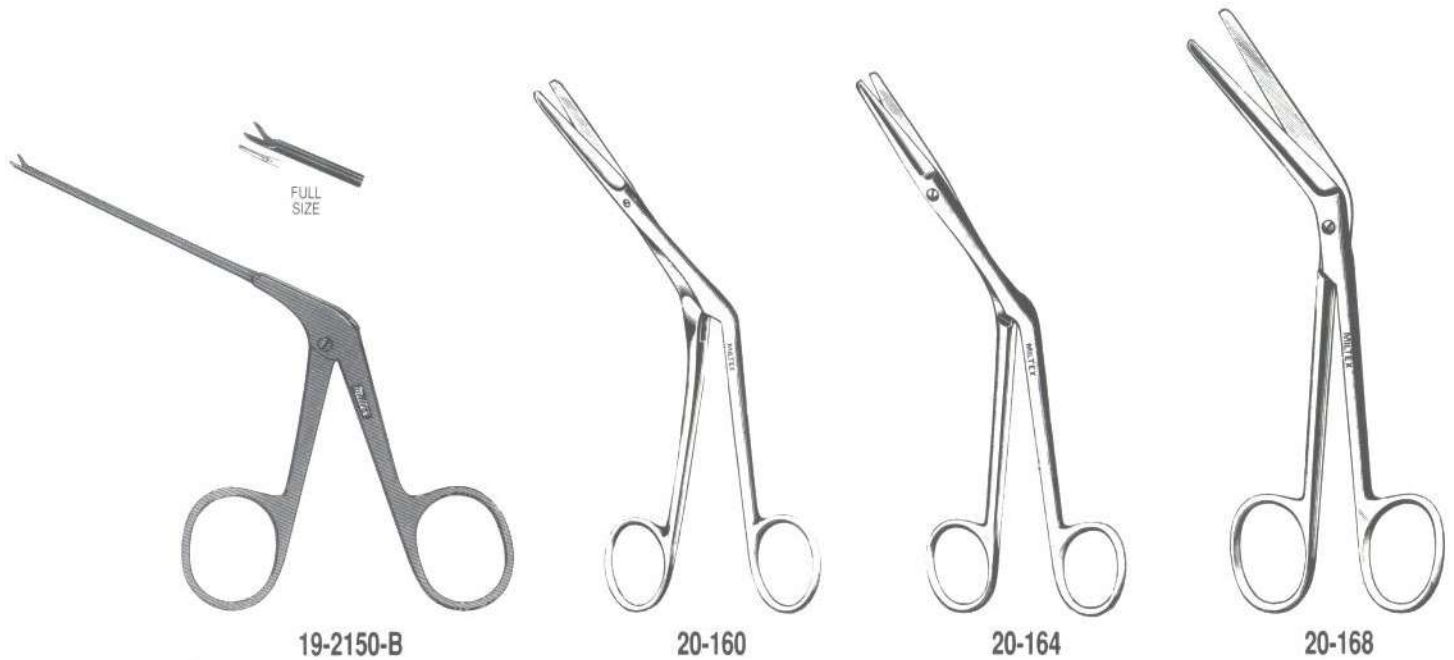

- 19-2150-B** BELLUCCI Micro Ear Scissors $2\frac{3}{4}$ " (7 cm) shaft, 4 mm blades, ebony finish
- 20-160** KNIGHT Nasal Scissors $6\frac{3}{4}$ " (17.1 cm), angled on side, standard pattern
- 20-164** HEYMAN Nasal Scissors $6\frac{3}{4}$ " (17.1 cm), angled on side, rounded blades
- 20-168** SEILER Turbinate Scissors $6\frac{1}{4}$ " (15.9 cm), angled on side



34-80



34-92



34-98



40-260



40-425

- 34-80** Dissecting Scissors 4½" (11.4 cm), straight, two sharp points, economy grade
- 34-92** RICHTER Dissecting Scissors 5" (12.7 cm), angular blades, one sharp and one blunt point
- 34-98** Enterotomy Scissors 8" (20.3 cm), with hook blade
- 40-260** Ingrown Nail Splitting Scissors 6" (15.2 cm), straight one serrated blade.
- 40-425** Nail Scissors 3½" (8.9 cm), curved blades, chrome
- 40-435** Cuticle Scissors 3½" (8.9 cm), curved blades, standard pattern, chrome
- 40-445** Cuticle Scissors 3½" (8.9 cm), curved blades, extra delicate, chrome



40-435



40-445



5-510 to 5-516



5-550



5-560



5-561



5-547

- 5-510 LISTER Bandage Scissors 3½" (8.9 cm), extra fine
- 5-512 LISTER Bandage Scissors 4½" (11.4 cm), extra fine
- 5-514 LISTER Bandage Scissors 5½" (14 cm), extra fine
- 5-516 LISTER Bandage Scissors 7¼" (18.4 cm), extra fine
- 5-550 LISTER Bandage Scissors 8" (20.3 cm), with one large finger ring

- 5-560 KNOWLES Bandage Scissors 5½" (14 cm), straight
- 5-561 KNOWLES Bandage Scissors 5½" (14 cm), shanks angled on side, serrated blade

- 5-547 HERCULES Heavy Duty Bandage and Plaster Shears 7½" (19.1 cm), serrated blade

- 5-564 U.S.A. Gauze Scissors 8" (20.3 cm), chrome



5-564

Bandage and Utility Scissors



5-568



5-600

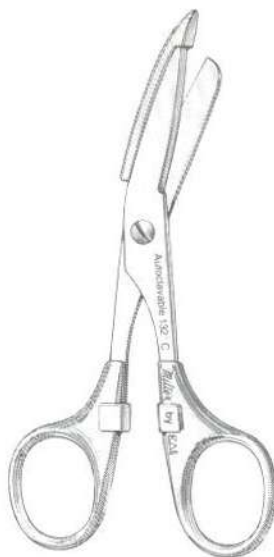

5-700
5-702

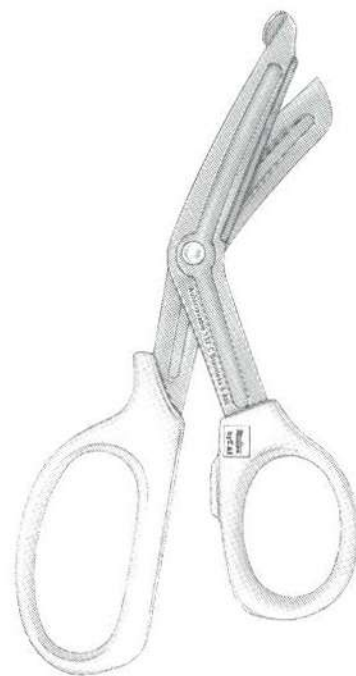

5-800



5-998
5-1000

5-568 ESMARCH Heavy Duty Bandage and Cast Shears 8" (20.3 cm)

5-600 MILTEX First Aid and Utility Shears 8½" (21.6 cm), with wire cutter and serrated blade

5-700 Nurse's Scissors 5½" (14 cm). Fluoride coated blades help prevent adhesive from sticking to the blade surfaces. Scissors have plastic finger rings and safety guard. Supplied in a plastic carrying pouch. Autoclavable

5-700 Pink

5-702 Blue

5-800 Bandage and Utility Scissors 8½" (21.6 cm), with fluoride coated blades to help prevent adhesive or fiberglass casting material from sticking to the blade surfaces. Neon green plastic finger rings, serrated blade. Autoclavable

5-998 Bandage and Utility Scissors 6½" (16.5 cm), with needle destroyer, black plastic finger rings, serrated blade. Autoclavable

5-1000 Bandage and Utility Scissors 7½" (19.1 cm), with needle destroyer, black plastic finger rings, serrated blade. Autoclavable



27-3059 to 27-3062



27-3070

- 27-3059 STILLE Plaster Shears 8" (20.3 cm), Pediatric Size, serrated blades
- 27-3060 STILLE Plaster Shears 11" (27.9 cm), Medium Size, serrated blades
- 27-3062 STILLE Plaster Shears 15" (38.2 cm), Standard Size, serrated blades

- 27-3070 BRUNS Plaster Shears 9¼" (23.5 cm), serrated blade

Carb-N-Sert Scissors



OUR TOP QUALITY LINE OF SURGICAL SCISSORS

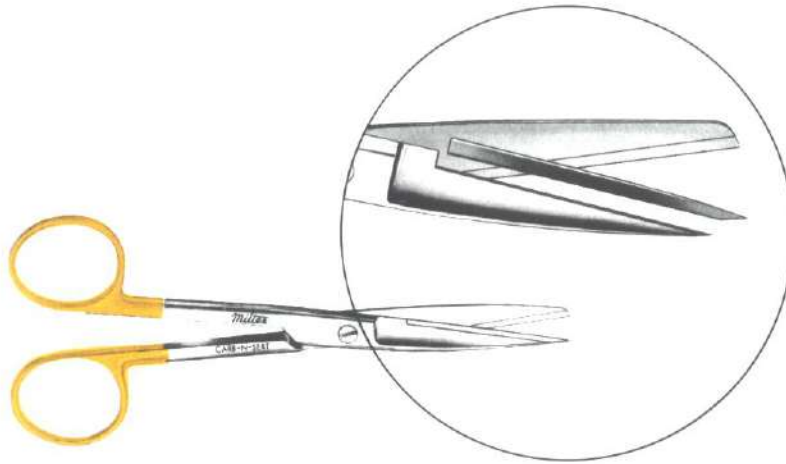

Manufactured to traditionally high Miltex standards, these tungsten carbide blades are bonded to the finest quality stainless steel surgical scissors, then precision ground and honed on diamond wheels.

- Precision screws, fully tempered, will keep these scissors in perfect alignment.
- Scissors shanks are tempered to a hardness that permits proper flexibility.
- Finger rings are well rounded and polished for better "feel" and prevention of finger fatigue, and each instrument is satin finished to reduce glare.

Gold plated finger rings identify these tungsten carbide instruments, and the Miltex catalog number has been etched on each scissors to facilitate re-ordering.

Carb-N-Sert Scissors will rarely require sharpening. While the initial cost of Carb-N-Sert Scissors is higher than standard stainless scissors, Carb-N-Sert Scissors represent a considerable savings to the user in the long run because of superior performance and longer service life.



Carb-N-Sert Scissors

CARB-N-SERT SCISSORS
with tungsten carbide insert blades will stay sharp for years

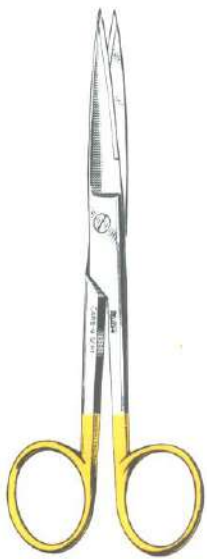

5-6TC

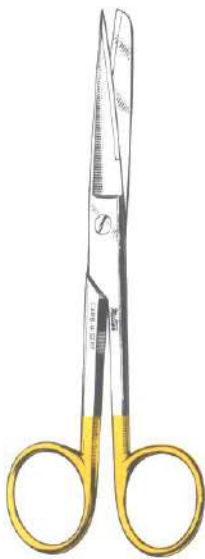

5-16TC

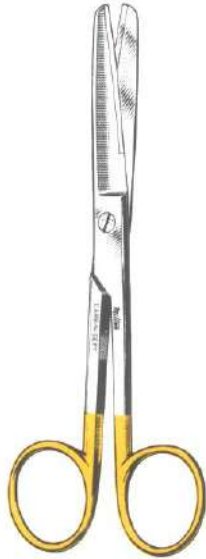

5-26TC

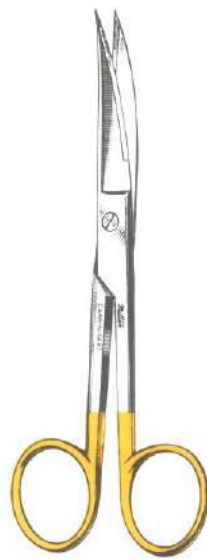

5-36TC



5-46TC

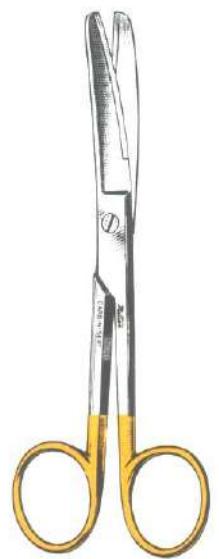

5-56TC

- | | |
|---------------|--|
| 5-6TC | Operating Scissors 5½" (14 cm), straight, sharp-sharp points |
| 5-16TC | Operating Scissors 5½" (14 cm), straight, sharp-blunt points |
| 5-26TC | Operating Scissors 5½" (14 cm), straight, blunt-blunt points |
| 5-36TC | Operating Scissors 5½" (14 cm), curved, sharp-sharp points |
| 5-46TC | Operating Scissors 5½" (14 cm), curved, sharp-blunt points |
| 5-56TC | Operating Scissors 5½" (14 cm), curved, blunt-blunt points |

Carb-N-Sert Scissors



CARB-N-SERT SCISSORS
with tungsten carbide insert blades will stay sharp for years



5-120TC
5-124TC

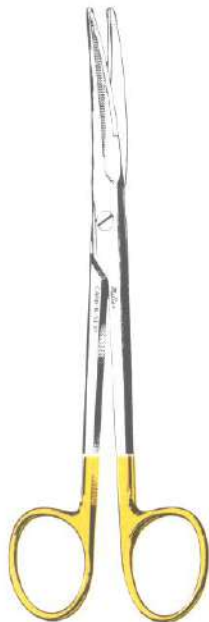

5-122TC
5-126TC

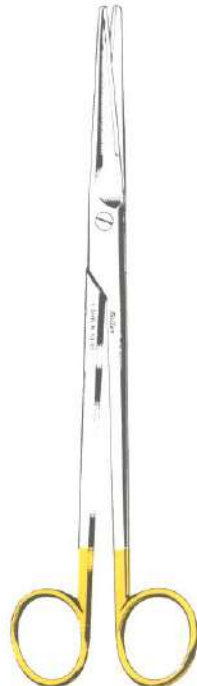

5-128TC
5-130TC

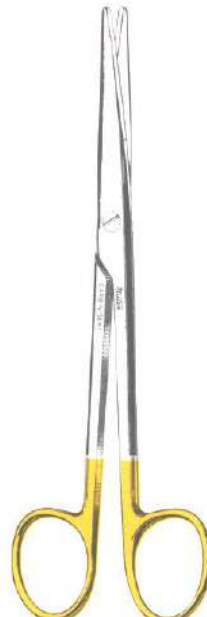

5-136TC
5-140TC

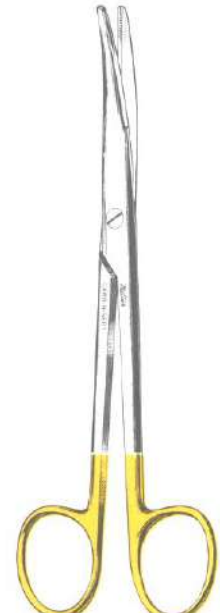

5-138TC
5-142TC

- | | |
|---------|---|
| 5-120TC | MAYO Dissecting Scissors 5½" (14 cm), straight, standard beveled blades |
| 5-122TC | MAYO Dissecting Scissors 5½" (14 cm), curved, standard beveled blades |
| 5-124TC | MAYO Dissecting Scissors 6¾" (17.1 cm), straight, standard beveled blades |
| 5-126TC | MAYO Dissecting Scissors 6¾" (17.1 cm), curved, standard beveled blades |
| 5-128TC | MAYO Dissecting Scissors 9" (22.9 cm), straight, standard beveled blades |
| 5-130TC | MAYO Dissecting Scissors 9" (22.9 cm), curved, standard beveled blades |
| 5-136TC | MAYO Dissecting Scissors 5½" (14 cm), straight, rounded blades |
| 5-138TC | MAYO Dissecting Scissors 5½" (14 cm), curved, rounded blades |
| 5-140TC | MAYO Dissecting Scissors 6¾" (17.1 cm), straight, rounded blades |
| 5-142TC | MAYO Dissecting Scissors 6¾" (17.1 cm), curved, rounded blades |

CARB-N-SERT SCISSORS
with tungsten carbide insert blades will stay sharp for years

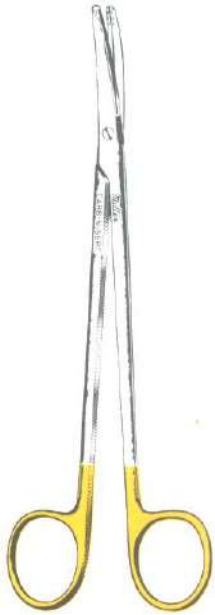

5-180TC
5-182TC

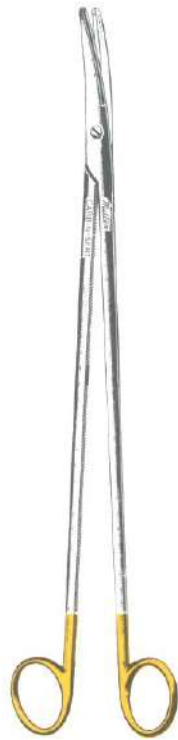

5-184TC 5-192TC
5-188TC 5-193A-TC
5-189A-TC



5-180A-TC

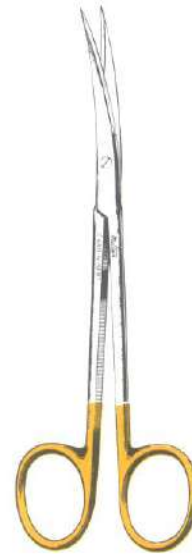

5-180B-TC



5-182A-TC

METZENBAUM SCISSORS STANDARD PATTERN — BLUNT POINTS

Straight	Length	Curved
5-179TC	5½" (14 cm)	5-180TC
5-181TC	7" (17.8 cm)	5-182TC
<i>5-183TC</i>	8" (20.3 cm)	5-184TC
5-186TC	9" (22.9 cm)	5-188TC
<i>5-185TC</i>	10" (25.4 cm)	5-189A-TC
<i>5-187TC</i>	11" (27.9 cm)	5-192TC
<i>5-190TC</i>	12" (30.5 cm)	5-193A-TC
<i>5-191TC</i>		

METZENBAUM SCISSORS - DELICATE PATTERN

Straight	Length	Curved
5-179A-TC	5½" (14 cm) blunt points	5-180A-TC
5-179B-TC	5½" (14 cm) sharp points	5-180B-TC
5-181A-TC	7" (17.8 cm) blunt points	5-182A-TC
5-181B-TC	7" (17.8 cm) sharp points	5-182B-TC
5-187TC	9" (22.9 cm) blunt points	5-189TC



5-189TC

Carb-N-Sert Scissors



CARB-N-SERT SCISSORS
with tungsten carbide insert blades will stay sharp for years



5-304TC



5-306TC



5-312TC



5-314TC

- 5-304TC Iris Scissors 4½" (11.4 cm), straight
- 5-306TC Iris Scissors 4½" (11.4 cm), curved
- 5-312TC Strabismus Scissors 4½" (11.4 cm), straight
- 5-314TC Strabismus Scissors 4½" (11.4 cm), curved



Carb-N-Sert Scissors

CARB-N-SERT SCISSORS
with tungsten carbide insert blades will stay sharp for years

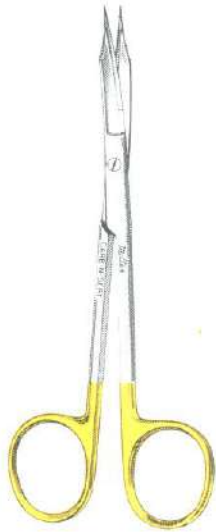

5-320TC



9-124TC



21-537TC



21-604TC

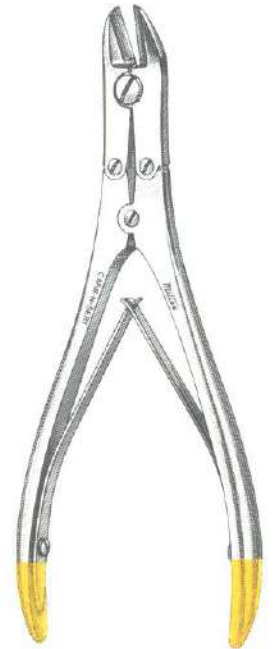

27-159TC

- 5-320TC** GOLDMAN-FOX Wound Debridement Scissors 5" (12.7 cm), curved fine tips, one serrated blade
- 9-124TC** Wire Cutting Scissors 4¾" (12.1 cm), angled to side, one serrated blade
- 21-537TC** MILTEX Blepharoplasty Scissors 4½" (11.4 cm), curved flat tips, one serrated blade
- 21-604TC** FOMON Dorsal Scissors, 5½" (14 cm), angled shanks
- 27-159TC** C-N-S Pin and Wire Cutter 7" (17.8 cm), double action, cuts up to 2 mm (5/64") soft wire or 1.5 mm (1/16") hard wire

SuperCut Scissors



5-SC-16



5-SC-46



5-SC-120
5-SC-124



5-SC-122
5-SC-126

The SuperCut blade has a specially designed Razor Sharp Edge that cuts effortlessly through tissue. The lower blade has micro fine serrations to prevent tissue slippage. For easy identification, Miltex SuperCut Scissors have one gold plated finger ring; SuperCut/Carb-N-Sert TC Scissors have two. The word SuperCut also appears on the specially designed Razor Sharp Blade.



- | | |
|-----------------|---|
| 5-SC-16 | Operating Scissors 5½" (14 cm), straight, sharp/blunt |
| 5-SC-46 | Operating Scissors 5½" (14 cm), curved, sharp/blunt |
| 5-SC-120 | MAYO Scissors 5½" (14 cm), straight |
| 5-SC-122 | MAYO Scissors 5½" (14 cm), curved |
| 5-SC-124 | MAYO Scissors 6¾" (17.1 cm), straight |
| 5-SC-126 | MAYO Scissors 6¾" (17.1 cm), curved |

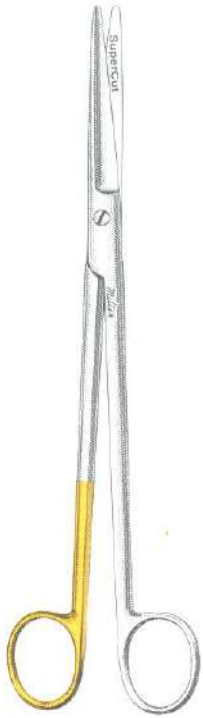

5-SC-128



5-SC-130



5-SC-180



5-SC-182



5-SC-188

5-SC-128 MAYO Scissors 9" (22.9 cm), straight

5-SC-130 MAYO Scissors 9" (22.9 cm), curved

5-SC-180 METZENBAUM Scissors 5½" (14 cm), curved

5-SC-182 METZENBAUM Scissors 7" (17.8 cm), curved

5-SC-188 METZENBAUM Scissors 9" (22.9 cm), curved



5-SC-283



5-SC-284



5-SC-304



5-SC-306



5-SC-320

- | | |
|----------|---|
| 5-SC-283 | METZENBAUM Scissors 4½" (11.4 cm), straight, delicate |
| 5-SC-284 | METZENBAUM Scissors 4½" (11.4 cm), curved, delicate |
| 5-SC-304 | Iris Scissors 4½" (11.4 cm), straight |
| 5-SC-306 | Iris Scissors 4½" (11.4 cm), curved |
| 5-SC-320 | GOLDMAN-FOX Scissors 5" (12.7 cm), curved |



18-SC-1472

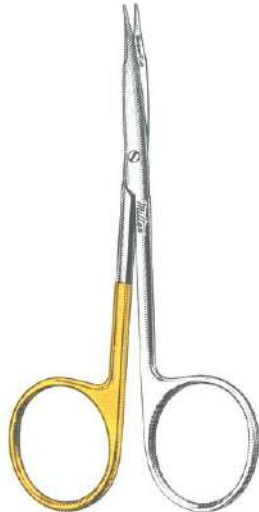

18-SC-1476



5-SC-182TC



5-SC-304TC



5-SC-306TC

18-SC-1472

STEVENS Tenotomy Scissors 4½" (11.4 cm), straight

18-SC-1476

STEVENS Tenotomy Scissors 4½" (11.4 cm), curved

5-SC-182TC

METZENBAUM Scissors 7" (17.8 cm), curved, SuperCut Carb-N-Sert Blades

5-SC-304TC

Iris Scissors 4½" (11.4 cm), straight, SuperCut Carb-N-Sert Blades

5-SC-306TC

Iris Scissors 4½" (11.4 cm), curved, SuperCut Carb-N-Sert Blades

Dressing and Tissue Forceps

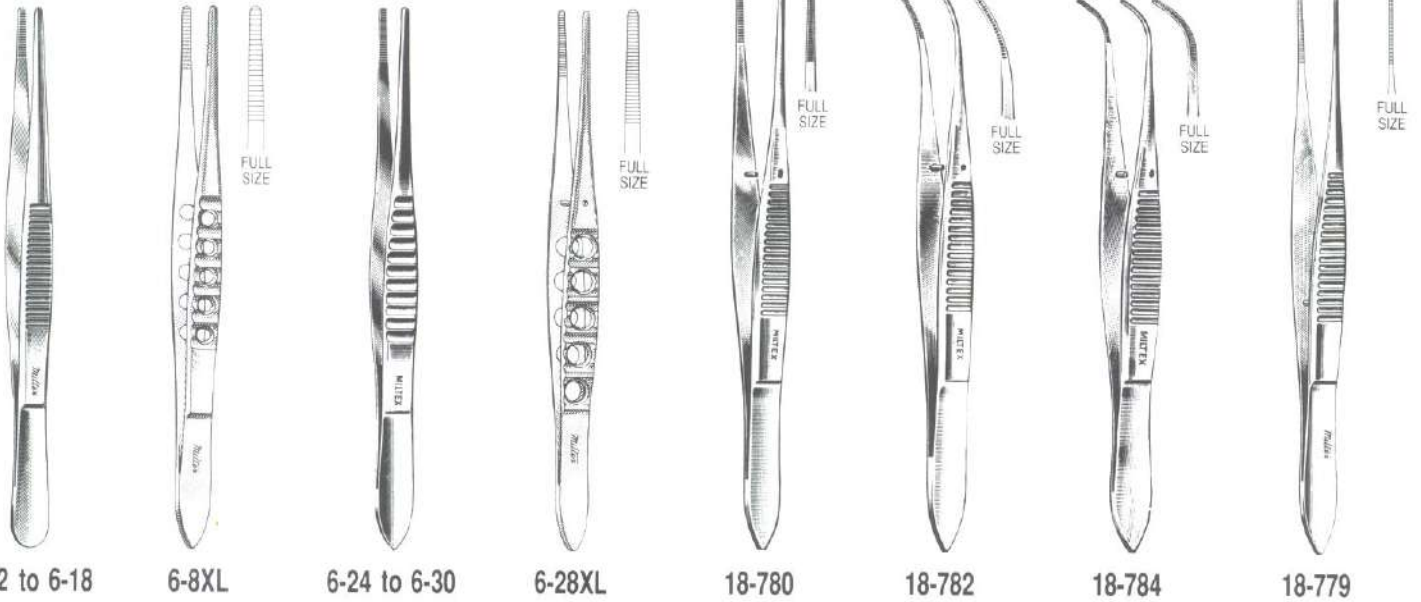

DRESSING FORCEPS, SERRATED TIPS

Standard Pattern Serrated Handles	Standard Pattern Lightweight with Fenestrated Handles	Length	Delicate Pattern Fluted Handles	Delicate Pattern Lightweight with Fenestrated Handles
6-2	—	4" (10.2 cm)	—	—
6-4	—	4½" (11.4 cm)	6-24	—
6-6	—	5" (12.7 cm)	6-26	—
6-8	6-8XL	5½" (14 cm)	6-28	6-28XL
6-10	—	6" (15.2 cm)	6-30	—
6-12	—	7" (17.8 cm)	—	—
6-14	—	8" (20.3 cm)	—	—
6-16	—	10" (25.4 cm)	—	—
6-18	—	12" (30.5 cm)	—	—

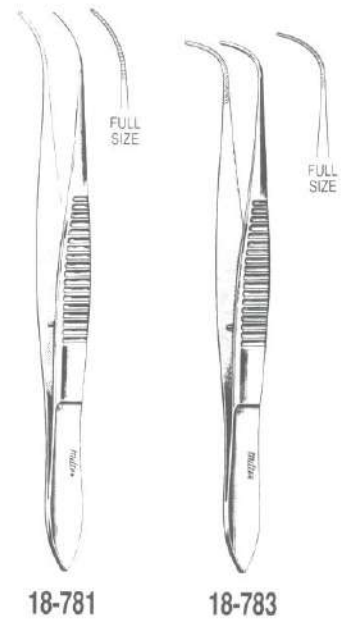

EYE DRESSING FORCEPS 4" (10.2cm), SERRATED TIPS

Standard Pattern 0.8 mm wide tips		Extra Delicate Pattern 0.5 mm wide tips	
18-780	Straight	18-779	Straight
18-782	Half curved	18-781	Half curved
18-784	Full curved	18-783	Full curved



6-40 to 6-86

FULL SIZE



6-44XL

FULL SIZE



6-90 to 6-96

FULL SIZE

TISSUE FORCEPS, 1 X 2 TEETH

Standard Pattern
Serrated Handles

Standard Pattern
Lightweight with
Fenestrated Handles

Length

Delicate Pattern
Fluted Handles

6-40	—	4½" (11.4 cm)	6-90
6-42	—	5" (12.7 cm)	6-92
6-44	6-44XL	5½" (14 cm)	6-94
6-46	—	6" (15.2 cm)	6-96
6-47	—	7" (17.8 cm)	—
6-48	—	8" (20.3 cm)	—
6-50	—	10" (25.4 cm)	—
6-52	—	12" (30.5 cm)	—
6-60	Tissue Forceps	4½" (11.4 cm)	2 x 3 teeth
6-62	Tissue Forceps	5" (12.7 cm)	2 x 3 teeth
6-64	Tissue Forceps	5½" (14 cm)	2 x 3 teeth
6-66	Tissue Forceps	6" (15.2 cm)	2 x 3 teeth
6-72	Tissue Forceps	5" (12.7 cm)	3 x 4 teeth
6-74	Tissue Forceps	5½" (14 cm)	3 x 4 teeth
6-76	Tissue Forceps	6" (15.2 cm)	3 x 4 teeth
6-82	Tissue Forceps	5" (12.7 cm)	4 x 5 teeth
6-84	Tissue Forceps	5½" (14 cm)	4 x 5 teeth
6-86	Tissue Forceps	6" (15.2 cm)	4 x 5 teeth

Dressing and Tissue Forceps



FULL
SIZE

18-786
18-787



FULL
SIZE

18-788



FULL
SIZE

18-790



FULL
SIZE

18-785

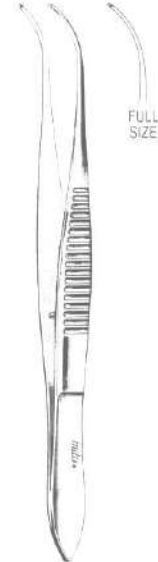

FULL
SIZE

18-789



FULL
SIZE

18-791

IRIS TISSUE FORCEPS 4" (10.2 cm), 1 x 2 TEETH

Standard Pattern
0.8 mm wide tips

- 18-786 Straight
- 18-787 Straight (Non Magnetic)
- 18-788 Half curved
- 18-790 Full curved

Extra Delicate Pattern
0.5 mm wide tips

- 18-785 Straight
- 18-789 Half curved
- 18-791 Full curved



6-100



6-104
6-109



6-106
6-108
6-109A



6-107

- 6-100** Dressing Forceps 5" (12.7 cm), curved narrow tips
- 6-104** SEMKEN Dressing Forceps 5" (12.7 cm), serrated
- 6-106** SEMKEN Tissue Forceps 5" (12.7 cm), 1 x 2 teeth
- 6-107** SEMKEN Tissue Forceps 5" (12.7 cm), 1 x 2 teeth, curved tips
- 6-108** SEMKEN Tissue Forceps 5" (12.7 cm), 2 x 3 teeth
- 6-109** SEMKEN Dressing Forceps 6" (15.2 cm), serrated
- 6-109A** SEMKEN Tissue Forceps 6" (15.2 cm), 1 x 2 teeth

Dressing and Tissue Forceps

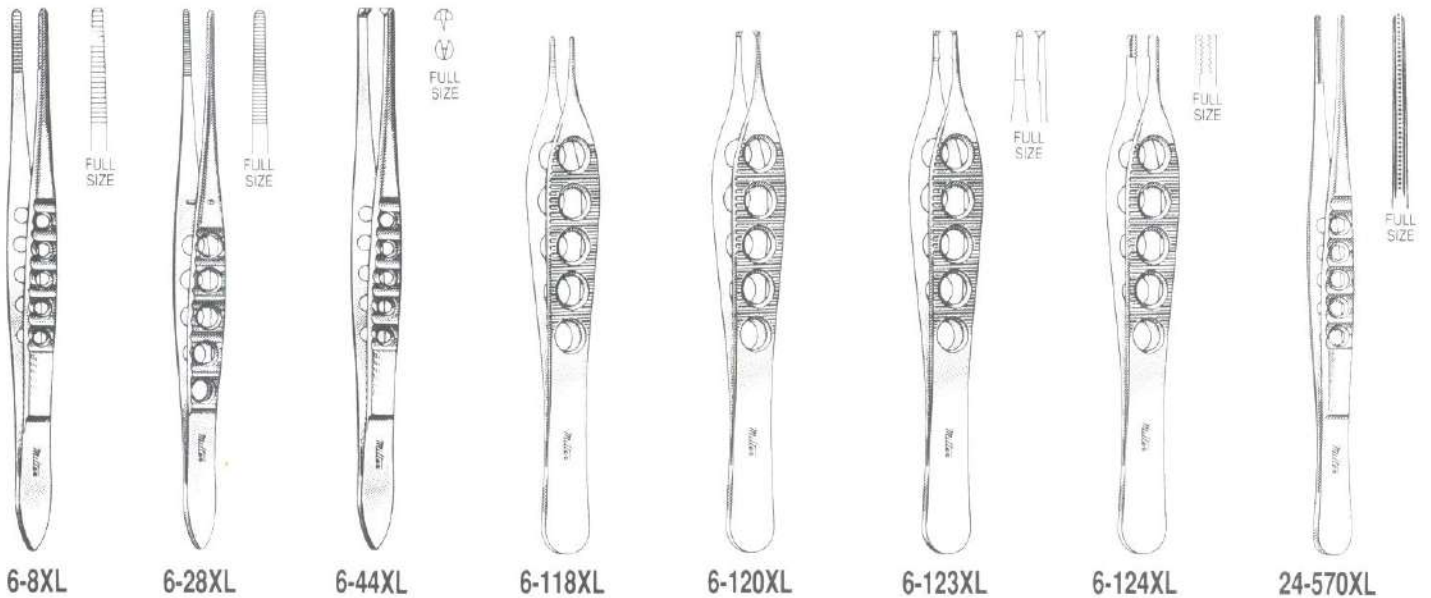

Lightweight Forceps with Fenestrated Handles provide the user with a firm, non-slip grip, reducing hand fatigue.

- 6-8XL** Dressing Forceps 5½" (14 cm), standard pattern
- 6-28XL** Dressing Forceps 5½" (14 cm), delicate pattern
- 6-44XL** Tissue Forceps 5½" (14 cm), 1 x 2 teeth, standard pattern
- 6-118XL** ADSON Dressing Forceps 4¾" (12.1 cm), serrated
- 6-120XL** ADSON Tissue Forceps 4¾" (12.1 cm), 1 x 2 teeth
- 6-123XL** ADSON Tissue Forceps 4¾" (12.1 cm), w/platform, 1 x 2 teeth
- 6-124XL** BROWN-ADSON Tissue Forceps 4¾" (12.1 cm), 7 x 7 side grasping teeth
- 24-570XL** DeBAKEY Tissue Forceps 6" (15.2 cm), atraumatic teeth, 1.5 mm wide tips

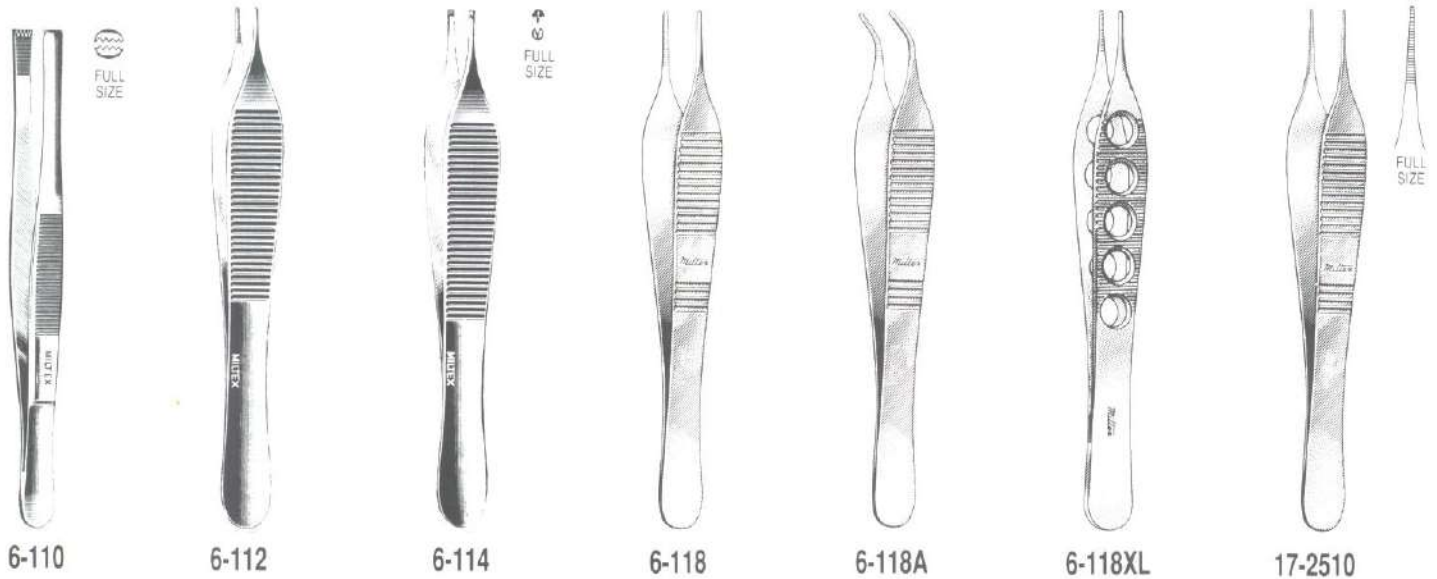

- 6-110** STILLE Pattern Tissue Forceps 5" (12.7 cm), 4 x 5 teeth
- 6-112** HUDSON (EWALD) Dressing Forceps 4¾" (12.1 cm), serrated
- 6-114** HUDSON (EWALD) Tissue Forceps 4¾" (12.1 cm), 1 x 2 teeth
- 6-118** ADSON Dressing Forceps 4¾" (12.1 cm), serrated, delicate
- 6-118A** ADSON Dressing Forceps 4¾" (12.1 cm), serrated, delicate, angled
- 6-118XL** ADSON Dressing Forceps 4¾" (12.1 cm), serrated, lightweight, fenestrated handles
- 17-2510** Micro ADSON Dressing Forceps 4¾" (12.1 cm), serrated tips, 0.5 mm wide

Dressing and Tissue Forceps

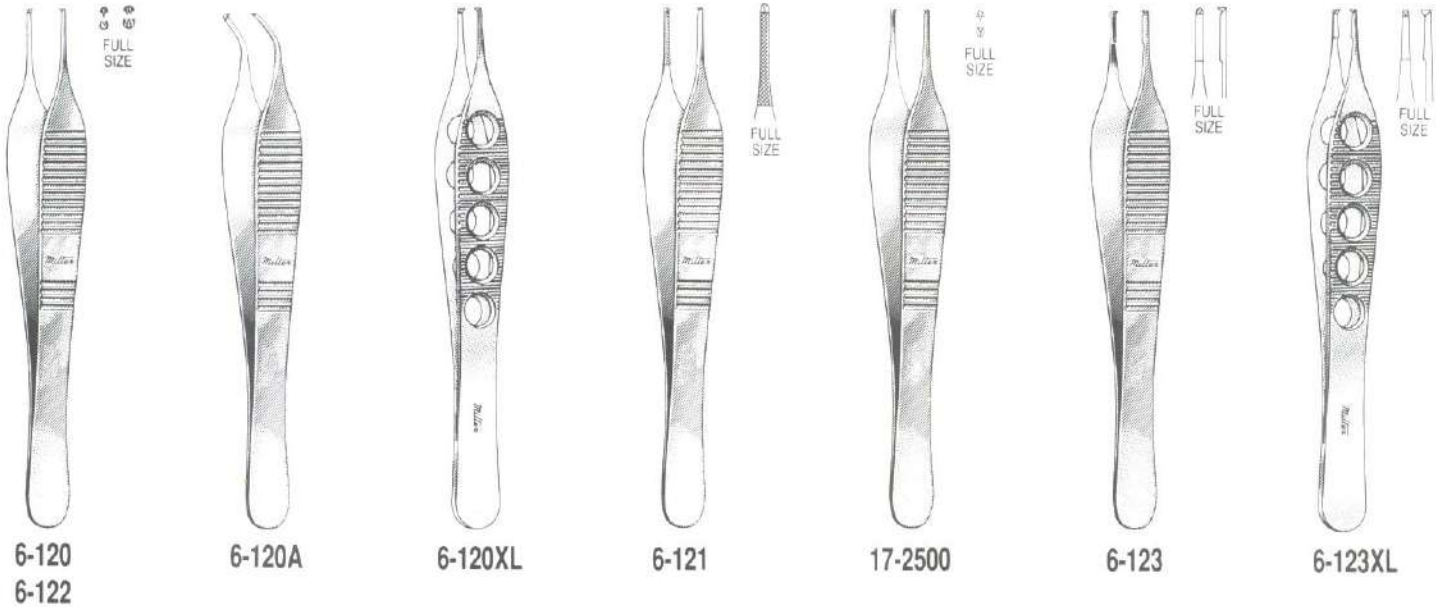

- 6-120** ADSON Tissue Forceps 4¾" (12.1 cm), 1 x 2 teeth, delicate
- 6-120A** ADSON Tissue Forceps 4¾" (12.1 cm), 1 x 2 teeth, delicate, angled
- 6-120XL** ADSON Tissue Forceps 4¾" (12.1 cm), 1 x 2 teeth, lightweight, fenestrated handles
- 6-121** ADSON Tissue Forceps 4¾" (12.1 cm), 1 x 2 teeth and cross serrated tips, delicate

17-2500 Micro ADSON Tissue Forceps 4¾" (12.1 cm), tips 0.5 mm wide, 1 x 2 teeth

- 6-122** ADSON Tissue Forceps 4¾" (12.1 cm), 2 x 3 teeth, delicate
- 6-123** ADSON Tissue and Suture Forceps 4¾" (12.1 cm), 1 x 2 teeth with tying platform
- 6-123XL** ADSON Tissue Forceps 4¾" (12.1 cm), w/platform, 1 x 2 teeth, lightweight, fenestrated handles

- 6-124** BROWN-ADSON Tissue Forceps 4¾" (12.1 cm), 7 x 7 side grasping teeth
- 6-124XL** BROWN-ADSON Tissue Forceps 4¾" (12.1 cm), 7 x 7 side grasping teeth, lightweight, fenestrated handles

6-125 DeBAKEY-ADSON Tissue Forceps 4¾" (12.1 cm), atraumatic tips 1.5 mm wide

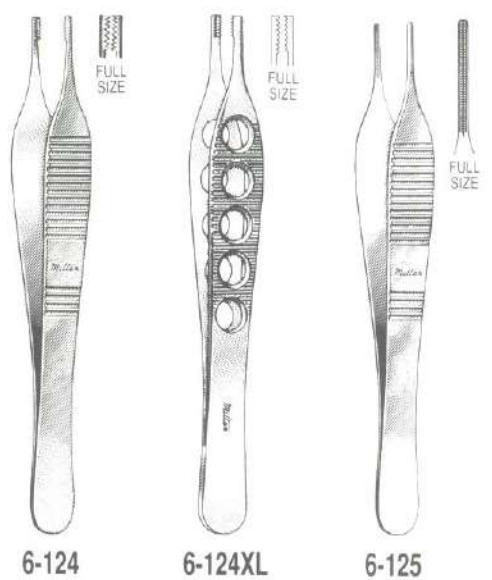

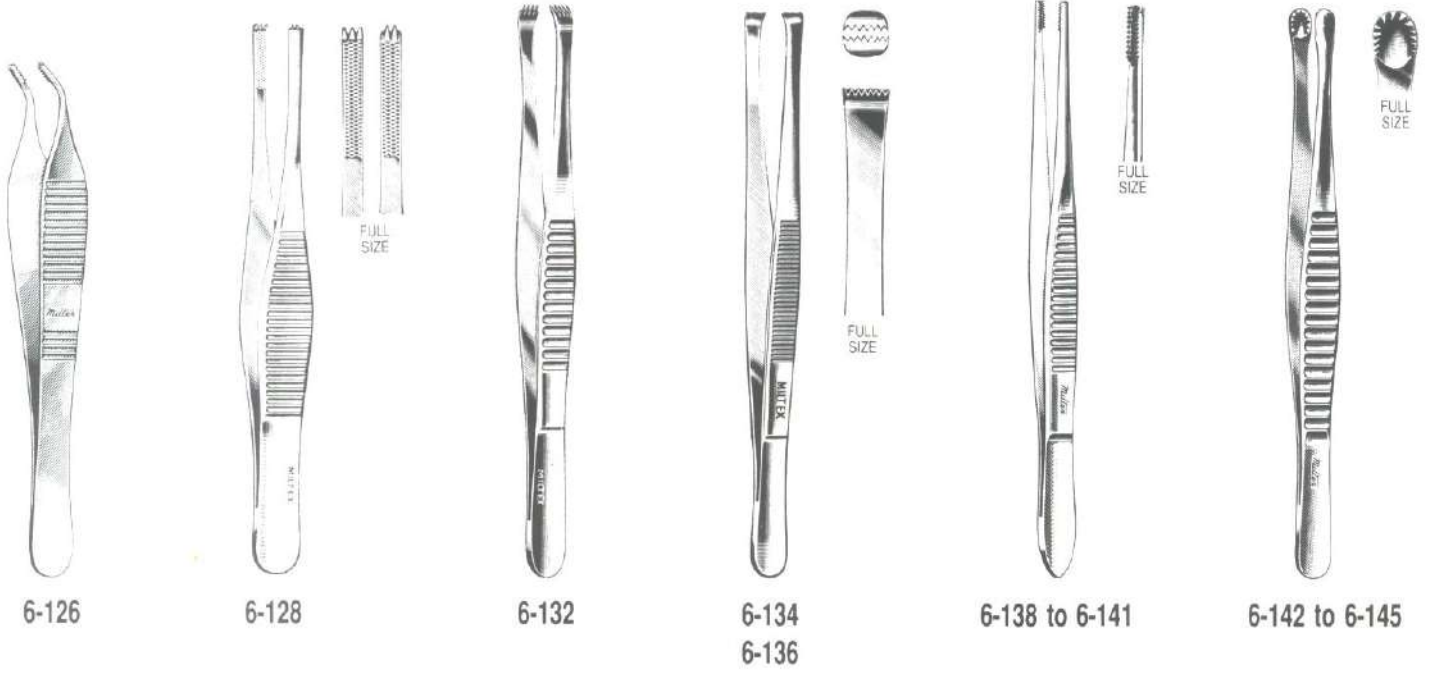

- 6-126 BROWN-ADSON Tissue Forceps 4¾" (12.1 cm), 7 x 7 side grasping teeth, angular
- 6-128 HEANEY Tissue Forceps 5½" (14 cm), 2 x 3 teeth and cross serrated tips
- 6-132 STONE Tissue Forceps 6" (15.2 cm), 4 x 5 teeth
- 6-134 MARTIN Tissue Forceps 6" (15.2 cm), 7 x 8 teeth
- 6-136 MARTIN Tissue Forceps 7½" (19.1 cm), 7 x 8 teeth
- 6-138 BROWN Tissue Forceps 6" (15.2 cm), 8 x 8 side grasping teeth
- 6-140 BROWN Tissue Forceps 8" (20.3 cm), 8 x 8 side grasping teeth
- 6-141 BROWN Tissue Forceps 10" (25.4 cm), 8 x 8 side grasping teeth
- 6-142 RUSSIAN Tissue Forceps 6" (15.2 cm)
- 6-144 RUSSIAN Tissue Forceps 8" (20.3 cm)
- 6-145 RUSSIAN Tissue Forceps 10" (25.4 cm)
- 6-148 BONNEY Tissue Forceps 7" (17.8 cm), 1 x 2 teeth and serrated tips
- 6-150 BONNEY Tissue Forceps 7" (17.8 cm), 2 x 3 teeth and serrated tips
- 6-154 POTTS-SMITH Dressing Forceps 7" (17.8 cm), serrated
- 6-156 POTTS-SMITH Dressing Forceps 8¼" (21 cm), serrated
- 6-158 POTTS-SMITH Dressing Forceps 9½" (24.1 cm), serrated
- 6-159 POTTS-SMITH Dressing Forceps 12" (30.5 cm), serrated

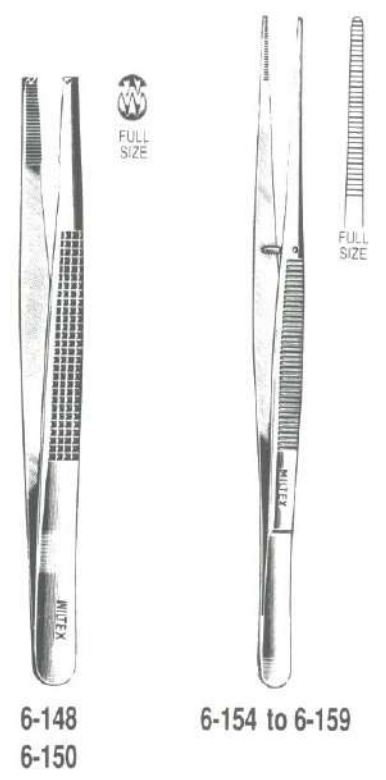

Dressing and Tissue Forceps



6-160 to 6-164A



6-166

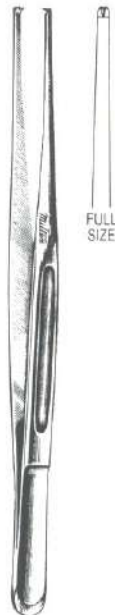

6-168



6-180

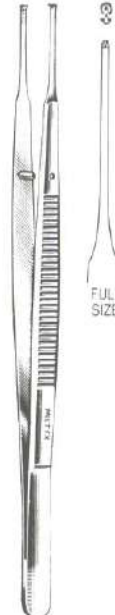

6-182

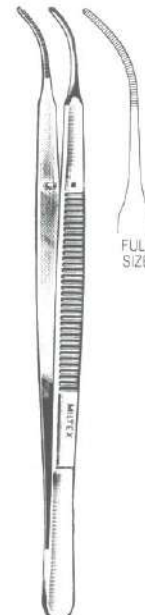

6-184

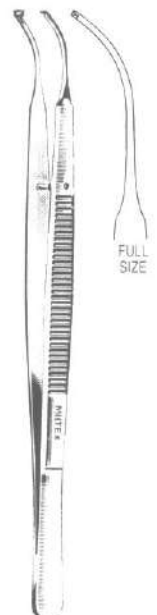

6-186

- 6-160 POTTS-SMITH Tissue Forceps 7" (17.8 cm), 1 x 2 teeth and serrated tips
- 6-162 POTTS-SMITH Tissue Forceps 8¼" (21 cm), 1 x 2 teeth and serrated tips
- 6-164 POTTS-SMITH Tissue Forceps 9½" (24.1 cm), 1 x 2 teeth and serrated tips
- 6-164A POTTS-SMITH Tissue Forceps 12" (30.5 cm), 1 x 2 teeth and serrated tips
- 6-166 CUSHING Dressing Forceps 7" (17.8 cm), serrated, Gutch handle, scraper end
- 6-168 CUSHING Tissue Forceps 7" (17.8 cm), 1 x 2 teeth, Gutch handle, scraper end
- 6-180 GERALD Dressing Forceps 7" (17.8 cm), straight, serrated
- 6-182 GERALD Tissue Forceps 7" (17.8 cm), straight, 1 x 2 teeth
- 6-184 GERALD Dressing Forceps 7" (17.8 cm), curved, serrated
- 6-186 GERALD Tissue Forceps 7" (17.8 cm), curved, 1 x 2 teeth
- 6-188 CUSHING Dressing Forceps 7" (17.8 cm), serrated, scraper end
- 6-189 CUSHING Tissue Forceps 7" (17.8 cm), 1 x 2 teeth, scraper end



6-188



6-189



6-190



6-192



6-197
6-198



6-200 to 6-204



FULL SIZE



6-210



FULL SIZE



6-212

FULL SIZE

- 6-190 CUSHING Dressing Forceps 7¼" (18.4 cm), bayonet, serrated, scraper end
- 6-192 CUSHING Tissue Forceps 7¼" (18.4 cm), bayonet, 1 x 2 teeth, scraper end
- 6-197 GRUENWALD (JANSEN) Bayonet Dressing Forceps 6½" (16.5 cm), serrated
- 6-198 ADSON Bayonet Dressing Forceps 8¼" (21 cm), serrated
- 6-200 KELLY Tissue Forceps 9" (22.9 cm), 1 x 2 teeth, slotted Gutch handle
- 6-202 KELLY Tissue Forceps 9" (22.9 cm), 2 x 3 teeth, slotted Gutch handle
- 6-204 KELLY Tissue Forceps 9" (22.9 cm), 3 x 4 teeth, slotted Gutch handle
- 6-210 MAYO RUSSIAN Tissue Forceps 9" (22.9 cm), fenestrated jaws, slotted grooved handles
- 6-212 DAVIS Tissue Forceps 10" (25.4 cm)
- 6-214 SINGLEY Tissue Forceps 9" (22.9 cm), fenestrated serrated jaws
- 16-80 WANGENSTEEN Tissue Forceps 9" (22.9 cm), rounded jaws with fine cross serrations



6-214



FULL SIZE



16-80

Dressing and Tissue Forceps

Miltex
M

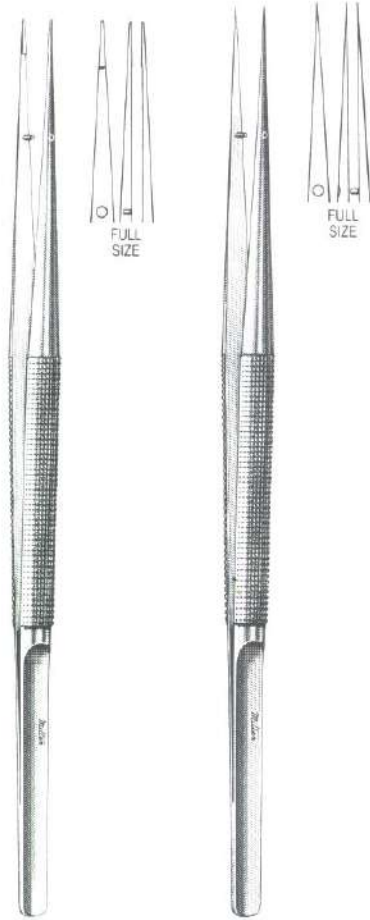

17-1100

17-1150



18-620
18-624



18-632



18-793



18-794

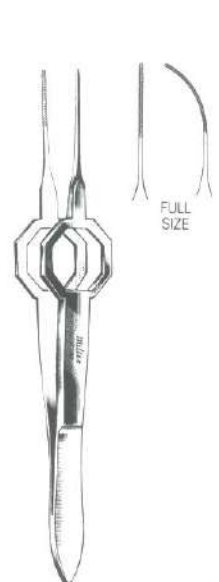

18-795
18-795A



18-796
18-798

- 17-1100 RHOTON Micro Suture Forceps 7" (17.8 cm), straight, with 0.7 mm tying platform
- 17-1150 RHOTON Micro Forceps 7" (17.8 cm), straight, 0.3 mm tips
- 18-620 KIRBY Iris Tissue Forceps 4" (10.2 cm), straight, 1 x 2 teeth
- 18-624 KIRBY Iris Tissue Forceps 4" (10.2 cm), curved, 1 x 2 teeth
- 18-632 KIRBY Tissue Forceps 4" (10.2 cm), angled tips with 1 x 2 teeth
- 18-793 O'CONNOR Iris Tissue Forceps 3¾" (9.5 cm), angular jaws 0.5 x 9 mm with 1 x 2 teeth
- 18-794 BRACKEN Iris Dressing Forceps 4" (10.2 cm), with fine cross-serrated tips
- 18-795 FOERSTER Eye Dressing Forceps 3¾" (9.5 cm), octagonal grip, straight, serrated tips 0.5 mm wide
- 18-795A FOERSTER Eye Dressing Forceps 3¾" (9.5 cm), octagonal grip, full curved, serrated tips 0.5 mm wide
- 18-796 FOERSTER Iris Tissue Forceps 3¾" (9.5 cm), octagonal grip, straight, 1 x 2 teeth, 0.5 mm wide
- 18-798 FOERSTER Iris Tissue Forceps 3¾" (9.5 cm), octagonal grip, full curved, 1 x 2 teeth, 0.5 mm wide

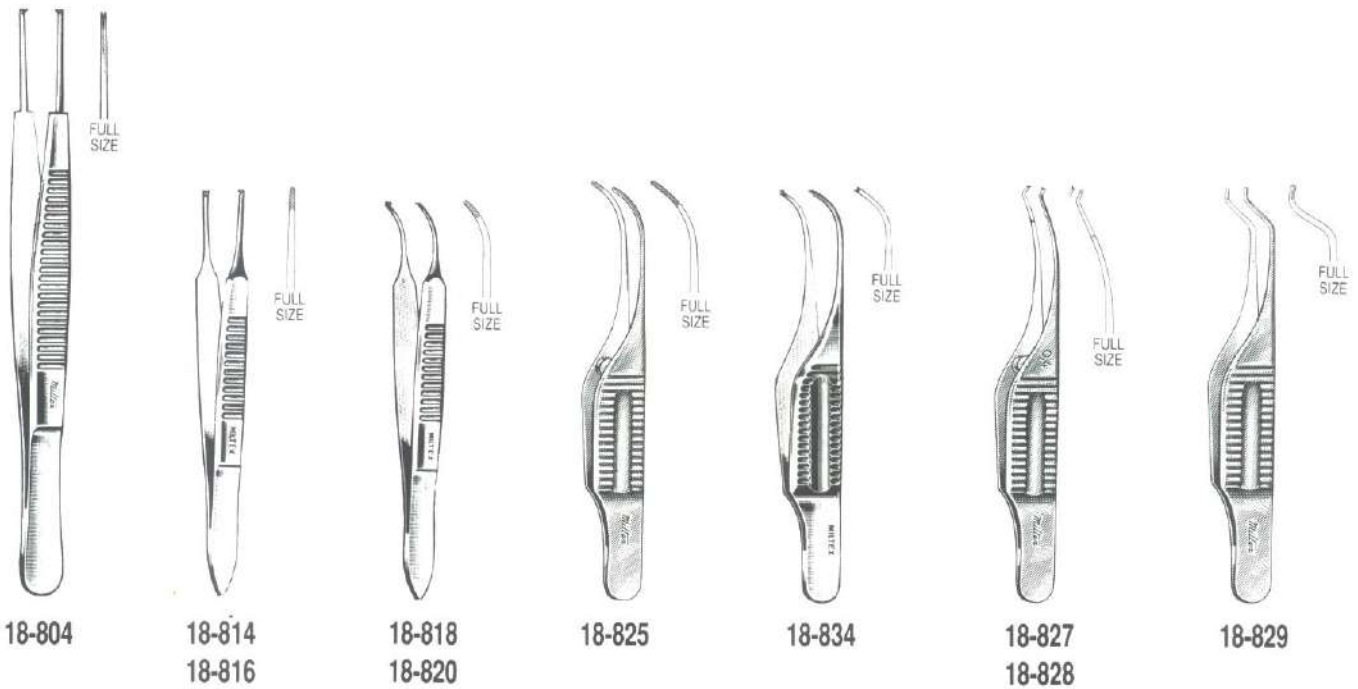

- 18-804** STEVENS Iris Tissue Forceps 4" (10.2 cm), straight, 1 x 2 teeth, 1 mm wide
- 18-814** GRAEFE Eye Dressing Forceps 2¾" (7 cm), straight, serrated
- 18-816** GRAEFE Iris Tissue Forceps 2¾" (7 cm), straight, 1 x 2 teeth
- 18-818** GRAEFE Eye Dressing Forceps 2¾" (7 cm), curved, serrated
- 18-820** GRAEFE Iris Tissue Forceps 2¾" (7 cm), curved, 1 x 2 teeth
- 18-825** GILL (CHANDLER) Iris Dressing Forceps 3" (7.6 cm), fine cross serrated tips, 0.6 mm wide
- 18-834** GILL Iris Tissue Forceps 2⅞" (7.3 cm), tips 0.6 mm wide, with 1 x 2 teeth
- 18-827** TROUTMAN-BARRAQUER Colibri Type Tissue Forceps 3" (7.6 cm), with 1 x 2 teeth, 0.4 mm, set at 45° angle, with tying platform
- 18-828** TROUTMAN-BARRAQUER Colibri Type Tissue Forceps 3" (7.6 cm), with 1 x 2 teeth, 0.12 mm, set at 45° angle, with tying platform
- 18-829** BOTVIN Iris Dressing Forceps 2⅞" (7.3 cm), fine cross serrated tips, 0.5 mm wide
- 18-830** GILL HESS Iris Forceps 2¾" (7 cm), with 1 x 2 teeth forward 0.5 mm
- 18-835** BONN Micro Tissue Forceps 2¾" (7 cm), 1 x 2 teeth 0.12 mm, with tying platform

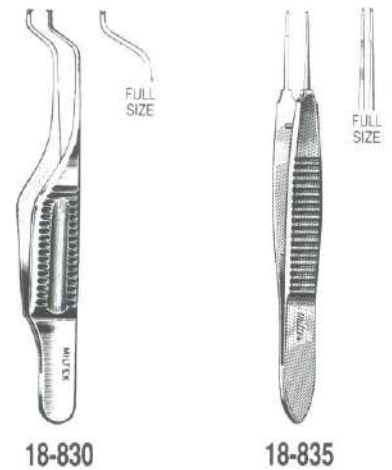

Dressing and Tissue Forceps

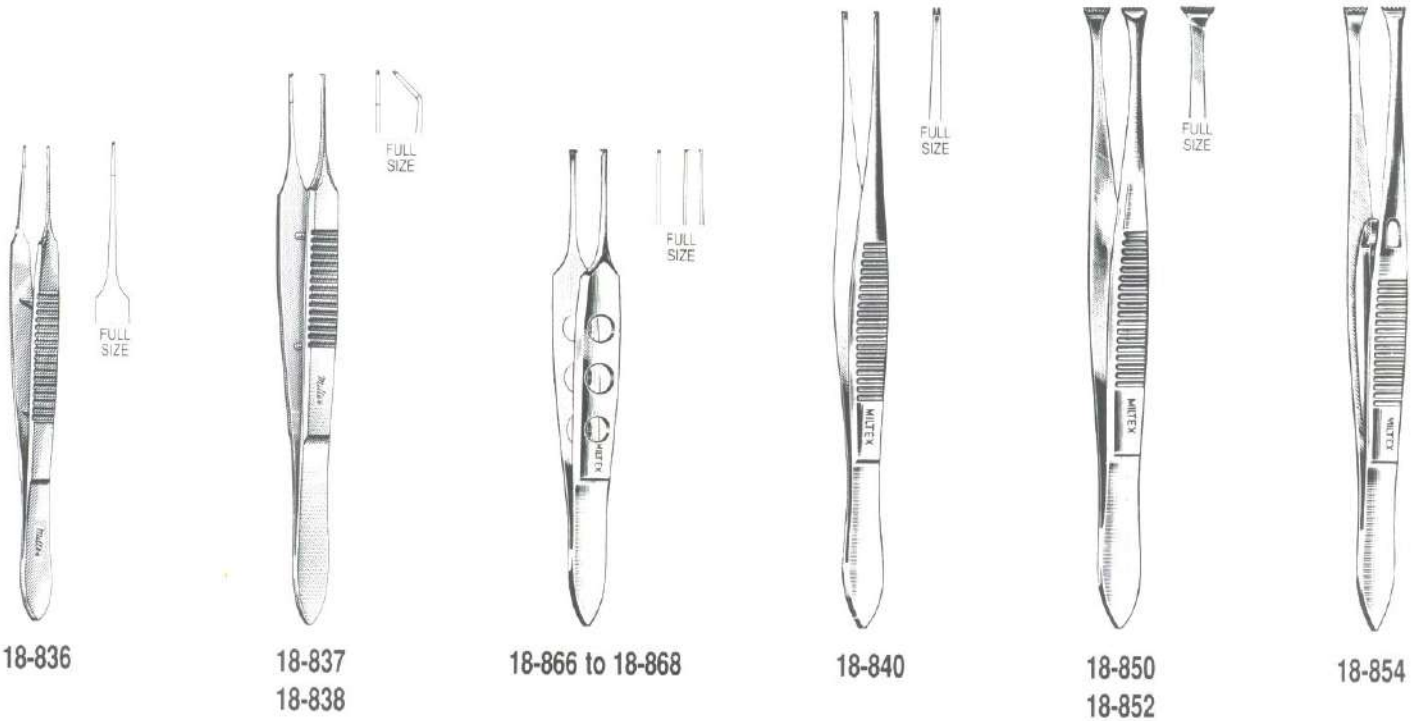

- 18-836** BONN Micro Tissue Forceps 3 $\frac{3}{4}$ " (9.5 cm), 1 x 2 teeth 0.12 mm, with tying platform
- 18-837** McPHERSON Micro Tissue Forceps 3 $\frac{1}{2}$ " (8.9 cm), straight, 1 x 2 teeth 0.2 mm, with tying platform
- 18-838** McPHERSON Micro Tissue Forceps 3 $\frac{1}{2}$ " (8.9 cm), angled, 1 x 2 teeth 0.2 mm, with tying platform
- 18-866** BISHOP-HARMON Dressing Forceps 3 $\frac{3}{8}$ " (8.6 cm), fine cross serrated tips 0.5 mm wide
- 18-867** BISHOP-HARMON Micro Tissue Forceps 3 $\frac{3}{8}$ " (8.6 cm), delicate 0.3 mm 1 x 2 teeth
- 18-868** BISHOP-HARMON Tissue Forceps 3 $\frac{3}{8}$ " (8.6 cm), standard 0.7 mm 1 x 2 teeth
- 18-840** Strabismus Tissue Forceps 4" (10.2 cm), 1 mm wide tips with 1 x 2 teeth
- 18-850** GRAEFE Tissue Forceps 4 $\frac{3}{8}$ " (11.2 cm), standard jaws 4.5 mm wide, with fine teeth
- 18-852** GRAEFE Tissue Forceps 4 $\frac{3}{8}$ " (11.2 cm), standard jaws 4.5 mm wide, with fine teeth, Non-Magnetic
- 18-854** GRAEFE Tissue Forceps 4 $\frac{3}{8}$ " (11.2 cm), standard jaws 4.5 mm wide, with fine teeth, with catch

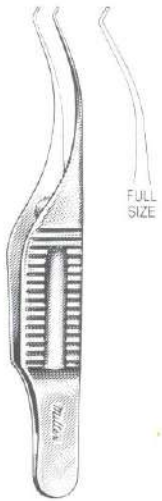

18-880
18-881



18-883

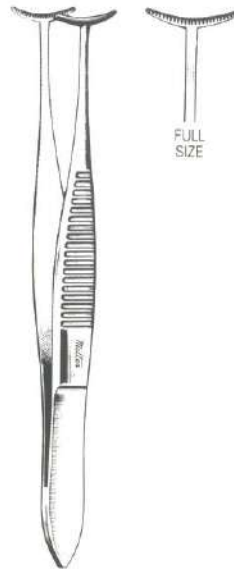

18-896
18-897



18-912

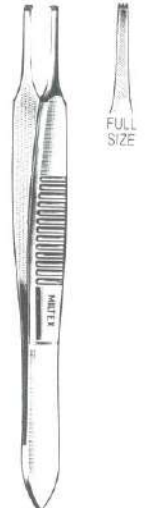

18-914

- 18-880 PIERSE Colibri Type Tissue Forceps 3¼" (8.3 cm), tips 0.12 mm
- 18-881 PIERSE Colibri Type Tissue Forceps 3¼" (8.3 cm), tips 0.3 mm
- 18-883 CASTROVIEJO Colibri Type Tissue Forceps 4" (10.2 cm), tips 0.12 mm, with tying platform
- 18-896 GREEN Tissue Forceps 4" (10.2 cm), T-shape, 12 mm wide 19 x 20 teeth
- 18-897 GREEN Tissue Forceps 4" (10.2 cm), T-shape, 5 mm wide 8 x 9 teeth
- 18-912 LESTER Tissue Forceps 3¾" (9.5 cm), delicate 1 x 2 teeth, 0.6 mm wide
- 18-914 LESTER Tissue Forceps 3¾" (9.5 cm), delicate 2 x 3 teeth, 1 mm wide

Dressing and Tissue Forceps

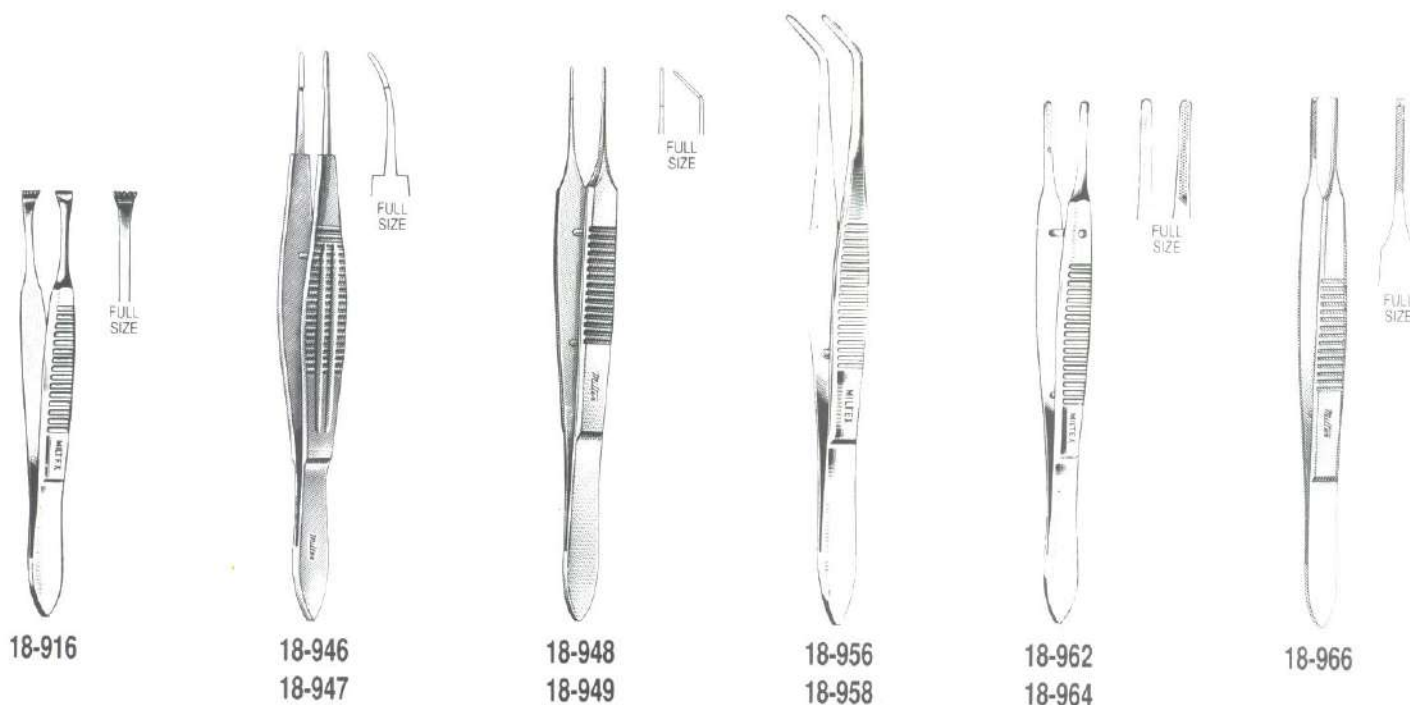

- 18-916** HARMON Tissue Forceps 3" (7.6 cm), 4 x 5 teeth, delicate 2.5 mm wide tips
- 18-946** HARMS Suturing Forceps 4 $\frac{1}{8}$ " (10.5 cm), straight, with 11 mm wide handles, tying platform, 0.6 mm wide at tip
- 18-947** HARMS Suturing Forceps 4 $\frac{1}{8}$ " (10.5 cm), curved, with 11 mm wide handles, tying platform, 0.6 mm wide at tip
- 18-948** McPHERSON Micro Iris Suturing Forceps 3 $\frac{1}{2}$ " (8.9 cm), straight, tying platform 0.3 x 5 mm, no teeth
- 18-949** McPHERSON Micro Iris Suturing Forceps 3 $\frac{1}{2}$ " (8.9 cm), angled, tying platform 0.3 x 5 mm, no teeth
- 18-956** NUGENT Utility Forceps 4 $\frac{1}{4}$ " (10.8 cm), smooth tips 1.2 mm wide
- 18-958** NUGENT Utility Forceps 4 $\frac{1}{4}$ " (10.8 cm), cross serrated tips 1.2 mm wide
- 18-962** McCULLOUGH Utility Forceps 4" (10.2 cm), smooth tips 1.5mm wide
- 18-964** McCULLOUGH Utility Forceps 4" (10.2 cm), cross serrated tips 1.5 mm wide
- 18-966** McCULLOUGH Suturing Forceps 4" (10.2 cm), cross serrated tips 1.5 mm wide with 1 x 2 teeth

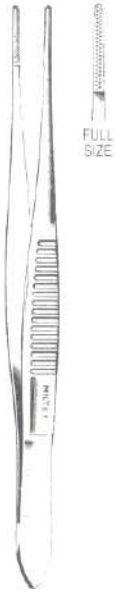

FULL
SIZE

18-970



FULL
SIZE

18-971



18-978



18-1100



18-1102



18-1104

- 18-970 WILLS HOSPITAL Utility Forceps 4" (10.2 cm), with cross serrated tying platform 1.2 mm wide
- 18-971 BONACCOLTO Utility Forceps 4" (10.2 cm), longitudinal serrations with cross serrations on tip, 1.2 mm wide with tapered tips
- 18-978 SCHAAF Foreign Body Forceps 3³/₄" (9.5 cm), grooved tips
- 18-1100 LITTAUER Cilia Forceps 3¹/₂" (8.9 cm), 4 mm wide jaws with fine horizontal serrations
- 18-1102 BEER Cilia Forceps 3¹/₂" (8.9 cm), 4 mm wide smooth jaws
- 18-1104 ZIEGLER Cilia Forceps 3¹/₂" (8.9 cm), 2 mm wide smooth jaws

Dressing and Tissue Forceps



18-1106



18-1107

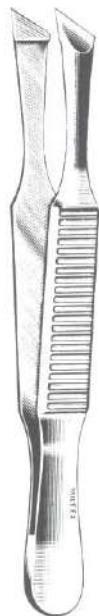

18-1108



18-1110

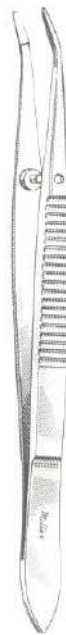

18-1111



18-1112



18-1114

- 18-1106 DOUGLAS Cilia Forceps 3½" (8.9 cm), thin tips 2.5 mm wide, with fine horizontal serrations
- 18-1107 Swiss Cilia and Suture Forceps 3¾" (9.5 cm), precision fitted diagonal jaws 3 mm wide
- 18-1108 BERGH Cilia Forceps 4¼" (10.8 cm), 10 mm wide jaws with horizontal serrations
- 18-1110 BERGH Cilia Forceps 3½" (8.9 cm), 5 mm wide jaws with horizontal serrations
- 18-1111 BARRAQUER Cilia and Suture Forceps 4½" (11.4 cm), with 5 mm smooth platform
- 18-1112 BENNETT Cilia Forceps 3" (7.6 cm), cup shaped jaws 3 mm diameter
- 18-1114 BEAUPRE Cilia Forceps 4½" (11.4 cm), smooth jaws 12 mm long, 45° angle
- 18-1116 GRADLE Cilia Forceps 4" (10.2 cm), precision ground jaws 1.4 mm wide



18-1116

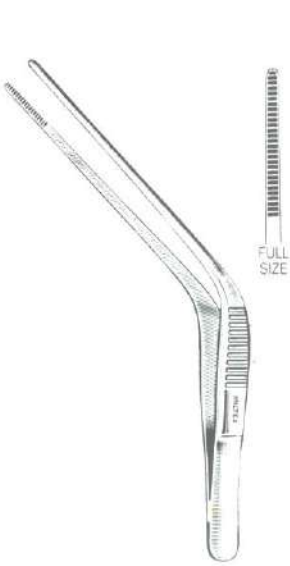

19-350



19-356

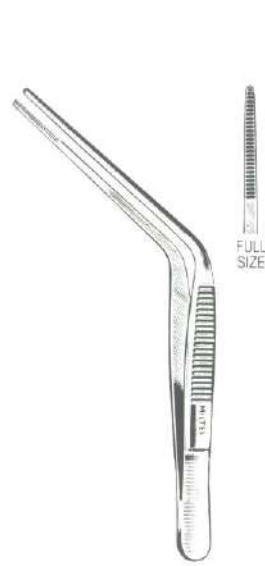

19-360



19-370



19-371

- 19-350 WILDE Dressing Forceps 5" (12.7 cm), angular with serrated tips
- 19-356 WILDE Dressing Forceps 5 1/4" (13.3 cm), cross action, angular with serrated tips
- 19-360 BLAKE Dressing Forceps 4 1/2" (11.4 cm), very delicate, angular with serrated tips
- 19-370 LUCAE Dressing Forceps 5 1/2" (14 cm), bayonet shape with serrated tips
- 19-371 JANSEN Dressing Forceps 6 1/4" (15.9 cm), bayonet shape, extra delicate pattern with 2 mm wide serrated tips
- 20-120 WILDE Dressing Forceps 6 1/2" (16.5 cm), angular

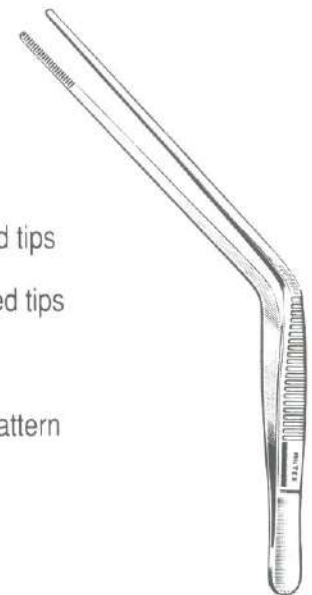

20-120



6-300
to
6-304



6-308



6-310



FULL
SIZE



6-312
6-314



FULL
SIZE



6-316
6-318

- | | |
|-------|--|
| 6-300 | Plain Splinter Forceps 3½" (8.9 cm) |
| 6-302 | Plain Splinter Forceps 4" (10.2 cm) |
| 6-304 | Plain Splinter Forceps 4½" (11.4 cm) |
| 6-308 | CARMALT Splinter Forceps 4¼" (10.8 cm), straight |
| 6-310 | CARMALT Splinter Forceps 4¼" (10.8 cm), curved |
| 6-312 | WALTER Splinter Forceps 4¼" (10.8 cm), straight |
| 6-314 | WALTER Splinter Forceps 4¼" (10.8 cm), curved |
| 6-316 | FEILCHENFELD Splinter Forceps 3" (7.6 cm) |
| 6-318 | FEILCHENFELD Splinter Forceps 4½" (11.4 cm) |

Splinter Forceps



V96-329



6-330

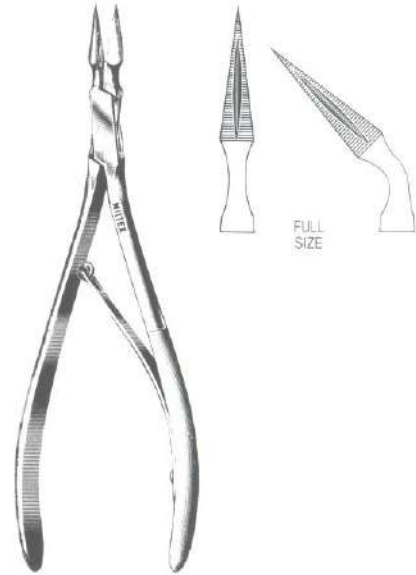

6-336
6-337

V96-329 Splinter Forceps 3" (7.6 cm), with magnifying glass, in carrying case

6-330 Physicians' Splinter Forceps 5" (12.7 cm)

6-336 VIRTUS Splinter Forceps 6" (15.2 cm), straight

6-337 VIRTUS Splinter Forceps 6" (15.2 cm), 45° angle

6-338 WILLIAMS Splinter Forceps 5½" (14 cm), straight

6-340 WILLIAMS Splinter Forceps 5½" (14 cm), 45° angle

6-342 WILLIAMS Splinter Forceps 5½" (14 cm), right angle

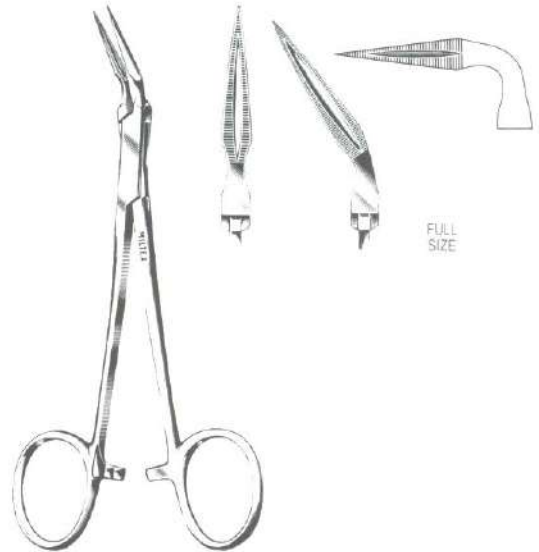

6-338
6-340
6-342

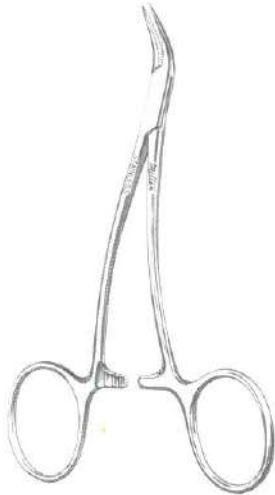

6-350



6-400



V96-410

V96-415

- 6-350** PEET Splinter Forceps 4 $\frac{3}{4}$ " (12.1 cm), double curve
- 6-400** MILTEX Splinter Liberator 5" (12.7 cm), trocar point in reversible handle
- V96-410** Professional Splinter Removal Kit. The Liberator is used to approach the embedded fragment by elevating the epidermis. After the fragment is exposed, the Walter Forceps is used for quick and easy removal of splinter.
- V96-415** Display carton with 12 ea. V96-410 Professional Splinter Removal Kits (not shown)



17-301



17-302



17-303



17-303C



17-303X



17-304

SWISS JEWELER STYLE FORCEPS Non-Magnetic Stainless Steel

- 17-301 Style 1, fine, 4 $\frac{3}{4}$ " (12.1 cm)
- 17-302 Style 2, strong, fine, 4 $\frac{3}{4}$ " (12.1 cm)
- 17-303 Style 3, narrow, fine, 4 $\frac{3}{4}$ " (12.1 cm)
- 17-303C Style 3C, narrow, fine, 4 $\frac{3}{8}$ " (11.2 cm)
- 17-303X Style 3, micro-fine, 4 $\frac{3}{4}$ " (12.1 cm)
- 17-304 Style 4, fine, 4 $\frac{3}{8}$ " (11.2 cm)
- 17-305 Style 5, super fine, 4 $\frac{3}{8}$ " (11.2 cm)



17-305



17-305X



17-306



17-307

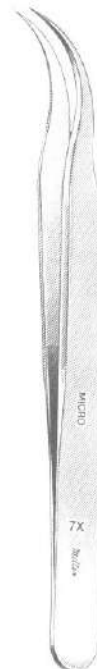

17-307X



18-980

SWISS JEWELER STYLE FORCEPS Non-Magnetic Stainless Steel

- 17-305X Style 5, micro-fine, 4 $\frac{3}{8}$ " (11.2 cm)
- 17-306 Style 6, pickup, 4 $\frac{1}{2}$ " (11.4 cm)
- 17-307 Style 7, fine curved, 4 $\frac{1}{2}$ " (11.4 cm)
- 17-307X Style 7, micro-fine, curved, 4 $\frac{1}{2}$ " (11.4 cm)
- 18-980 THORPE Splinter Forceps 4" (10.2 cm), very sharp points, fine serrated tips

Carb-N-Sert Dressing and Tissue Forceps



CARB-N-SERT DRESSING & TISSUE FORCEPS
with tungsten carbide insert tips permit atraumatic and firm
grasp of tissue. Tips have 4000 teeth per square inch



- 6-30TC** Dressing Forceps 6" (15.2 cm), cross serrated tips
- 6-118TC** ADSON Dressing Forceps 4¾" (12.1 cm), cross serrated tips
- 6-123TC** ADSON Tissue and Suture Forceps 4¾" (12.1 cm), 1 x 2 teeth and cross serrated tying platform
- 6-124TC** BROWN-ADSON Tissue and Suture Forceps 4¾" (12.1 cm), 7 x 7 side grasping teeth and cross serrated tying platform

Carb-N-Sert Dressing and Tissue Forceps

CARB-N-SERT DRESSING & TISSUE FORCEPS
with tungsten carbide insert tips permit atraumatic and firm
grasp of tissue. Tips have 4000 teeth per square inch



6-154TC to 6-158TC

6-165TC

6-166TC

6-198TC

- 6-154TC POTTSMITH Dressing Forceps 7" (17.8 cm), cross serrated tips
- 6-156TC POTTSMITH Dressing Forceps 8¼" (21 cm), cross serrated tips
- 6-158TC POTTSMITH Dressing Forceps 9¾" (24.8 cm), cross serrated tips
- 6-165TC EVANS Pelvic Tissue Forceps 10" (25.4 cm), cross serrated tips
- 6-166TC CUSHING Dressing Forceps 7" (17.8 cm), Gutch handle, cross serrated tips
- 6-198TC ADSON Bayonet Dressing Forceps 8½" (21.6 cm), cross serrated tips

Hemostatic Forceps



7-2
7-4



18-1934
18-1936



7-8
7-10

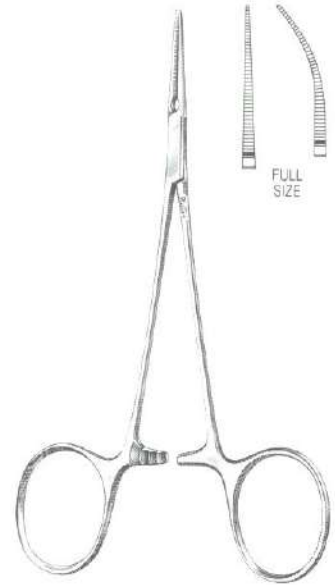

17-2600
17-2602

- 7-2 HALSTED Mosquito Forceps 5" (12.7 cm), straight
- 7-4 HALSTED Mosquito Forceps 5" (12.7 cm), curved
- 18-1934 Non-Magnetic HALSTED Mosquito Forceps 5" (12.7 cm)
- 18-1936 Non-Magnetic HALSTED Mosquito Forceps 5" (12.7 cm)
- 7-8 HALSTED Mosquito Forceps 5" (12.7 cm), straight, extra delicate
- 7-10 HALSTED Mosquito Forceps 5" (12.7 cm), curved, extra delicate
- 17-2600 JACOBSON Micro Mosquito Forceps 5" (12.7 cm), straight, extremely delicate
- 17-2602 JACOBSON Micro Mosquito Forceps 5" (12.7 cm), curved, extremely delicate
- 7-11 PACKER Mosquito Forceps 5" (12.7 cm), straight, flat jaws
- 7-12 PACKER Mosquito Forceps 5" (12.7 cm), curved, flat jaws

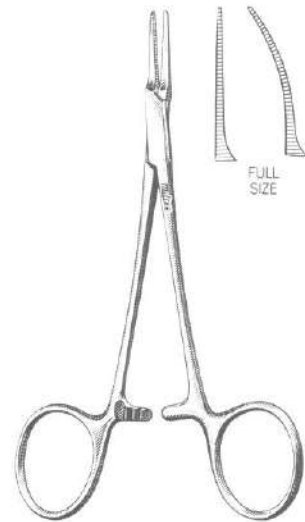

7-11
7-12



7-14
7-16



7-20



7-24
7-26

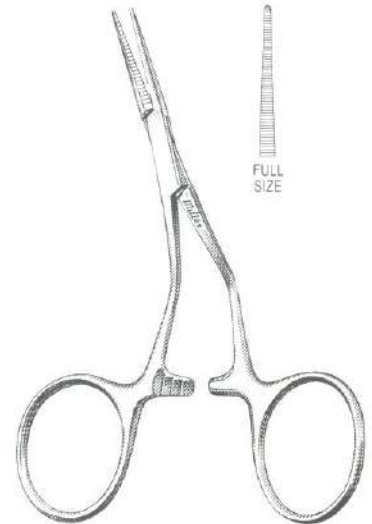

7-24A

- 7-14 HALSTED Mosquito Forceps 5" (12.7 cm), straight, 1 x 2 teeth
- 7-16 HALSTED Mosquito Forceps 5" (12.7 cm), curved, 1 x 2 teeth
- 7-20 HALSTED Mosquito Forceps 5" (12.7 cm), jaws 45° angled on flat, extra delicate
- 7-24 HARTMAN Mosquito Forceps 3½" (8.9 cm), straight
- 7-26 HARTMAN Mosquito Forceps 3½" (8.9 cm), curved
- 7-24A HARTMAN LEE Mosquito Forceps 3½" (8.9 cm), straight jaws, shanks angled on flat
- 7-30 PROVIDENCE HOSPITAL Forceps 5½" (14 cm), straight
- 7-32 PROVIDENCE HOSPITAL Forceps 5½" (14 cm), curved

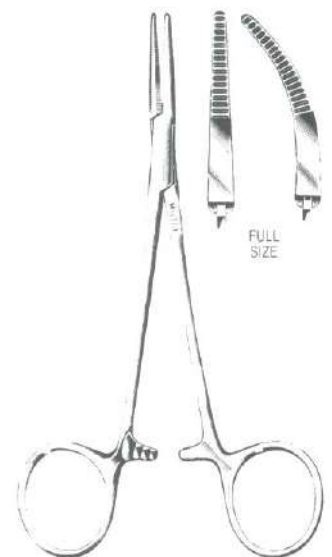

7-30
7-32

Hemostatic Forceps

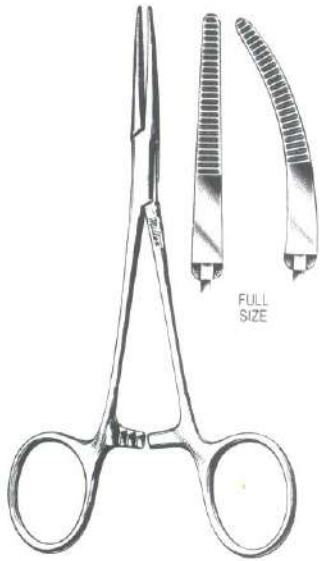

7-36
7-38

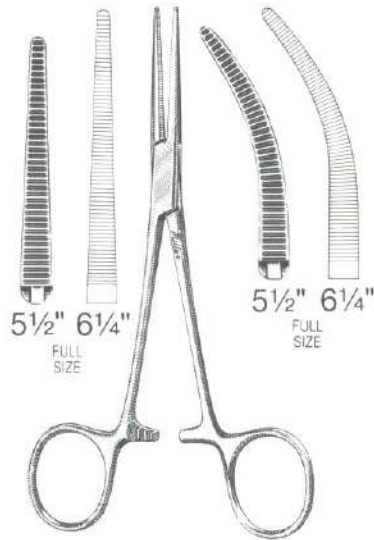

7-42 to 7-48

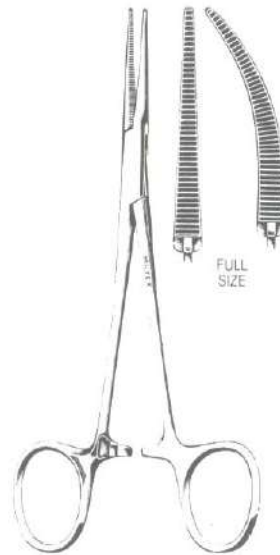

7-50
7-52

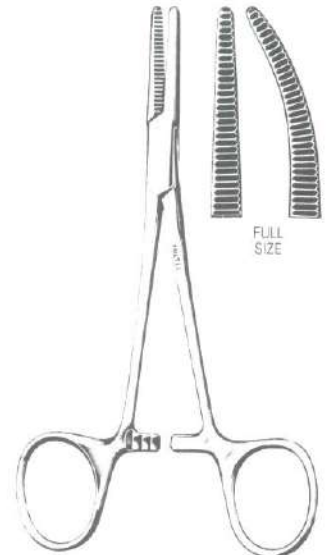

7-60
7-62

- 7-36 KELLY Forceps 5½" (14 cm), straight
- 7-38 KELLY Forceps 5½" (14 cm), curved
- 7-42 CRILE Forceps 5½" (14 cm), straight
- 7-44 CRILE Forceps 5½" (14 cm), curved
- 7-46 CRILE Forceps 6¼" (15.9 cm), straight
- 7-48 CRILE Forceps 6¼" (15.9 cm), curved
- 7-50 Baby CRILE Forceps 5½" (14 cm), straight, extra delicate
- 7-52 Baby CRILE Forceps 5½" (14 cm), curved, extra delicate
- 7-60 LAHEY Hemostatic Forceps 5½" (14 cm), straight
- 7-62 LAHEY Hemostatic Forceps 5½" (14 cm), curved
- 7-66 KOCHER Forceps 5½" (14 cm), straight, 1 x 2 teeth
- 7-68 KOCHER Forceps 5½" (14 cm), curved, 1 x 2 teeth

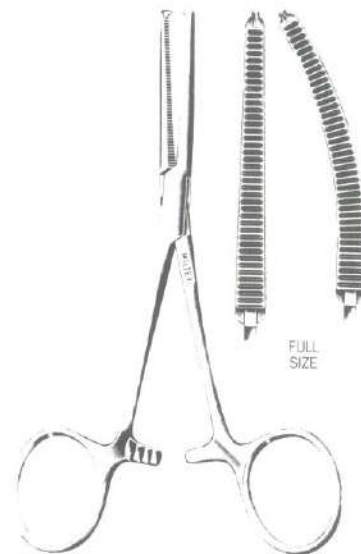

7-66
7-68

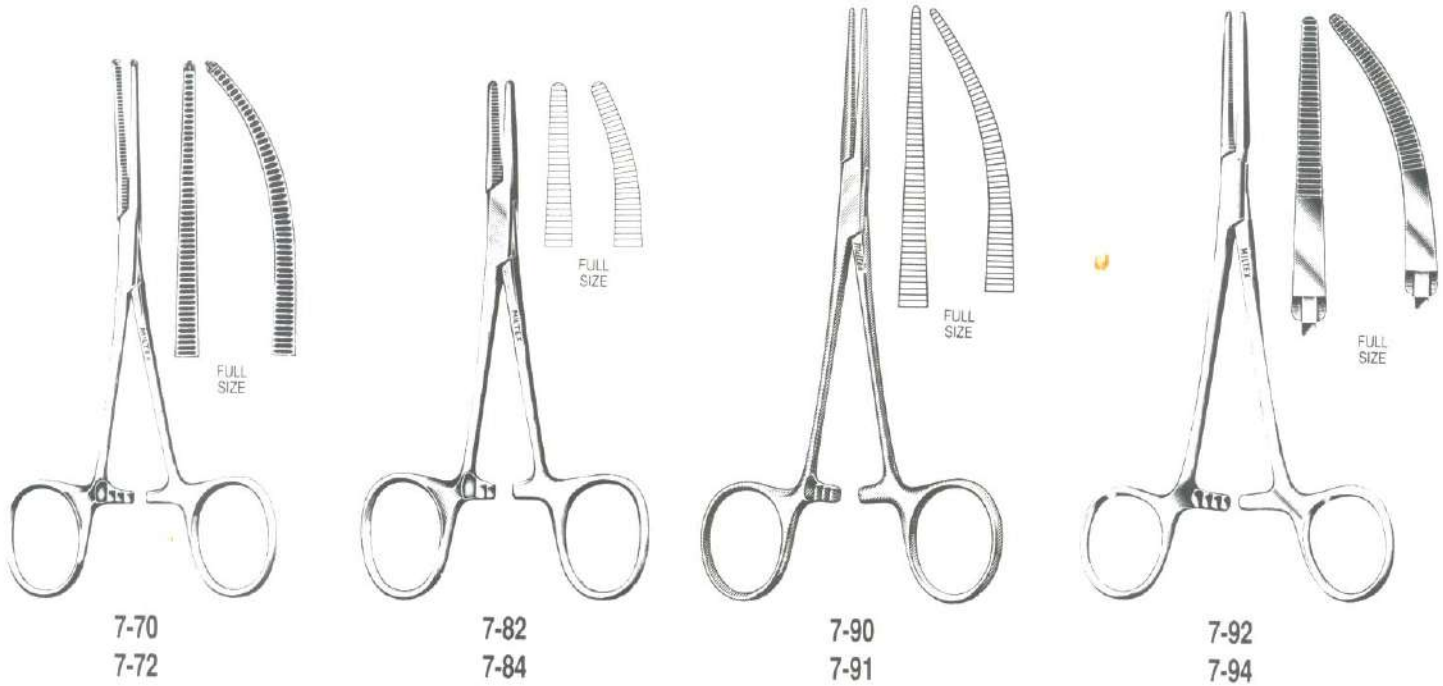

- 7-70 Baby OCHSNER Forceps 5½" (14 cm), straight, 1 x 2 teeth, extra delicate
- 7-72 Baby OCHSNER Forceps 5½" (14 cm), curved, 1 x 2 teeth, extra delicate
- 7-82 JONES Forceps 5" (12.7 cm), straight
- 7-84 JONES Forceps 5" (12.7 cm), curved
- 7-90 COLLER Forceps 6¼" (15.9 cm), straight, delicate
- 7-91 COLLER Forceps 6¼" (15.9 cm), curved, delicate
- 7-92 RANKIN Forceps 6¼" (15.9 cm), straight
- 7-94 RANKIN Forceps 6¼" (15.9 cm), curved
- 7-98 LOVELACE Hemostatic Forceps 6¼" (15.9 cm), straight, cross serrations, 1 x 2 teeth

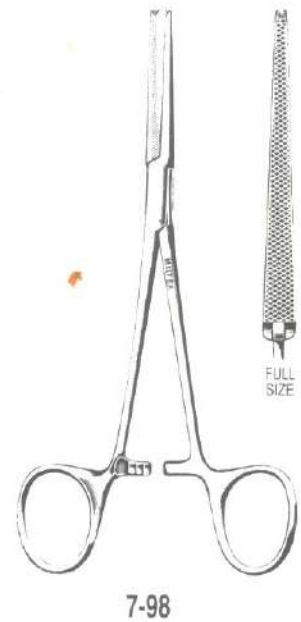

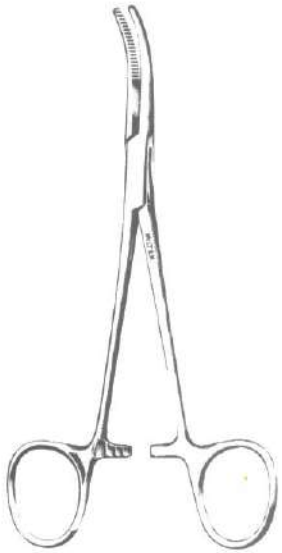

7-102

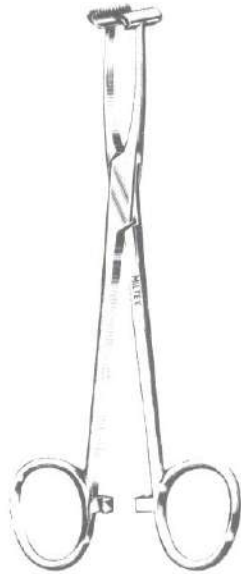

7-106



7-110
7-112

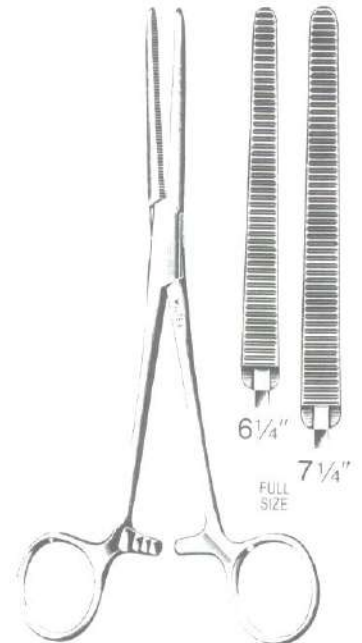

7-118 to 7-130

- 7-102 DANDY Forceps 5½" (14 cm), curved sideways
- 7-106 PRATT T-Shape Forceps 6" (15.2 cm)
- 7-110 Baby PEAN Forceps 5½" (14 cm), straight, extra delicate
- 7-112 Baby PEAN Forceps 5½" (14 cm), curved, extra delicate

ROCHESTER PEAN FORCEPS

Straight	Length	Curved
7-118	5½" (14 cm)	7-136
7-120	6¼" (15.9 cm)	7-138
7-122	7¼" (18.4 cm)	7-140
7-124	8" (20.3 cm)	7-142
7-126	9" (22.9 cm)	7-144
7-128	10¼" (26 cm)	7-146
7-130	12" (30.5 cm)	7-148

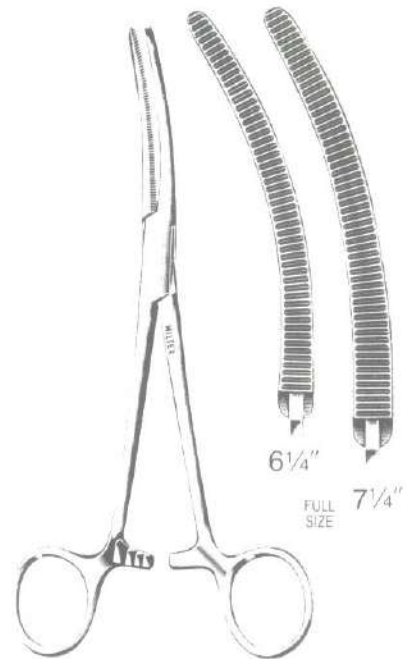

7-136 to 7-148

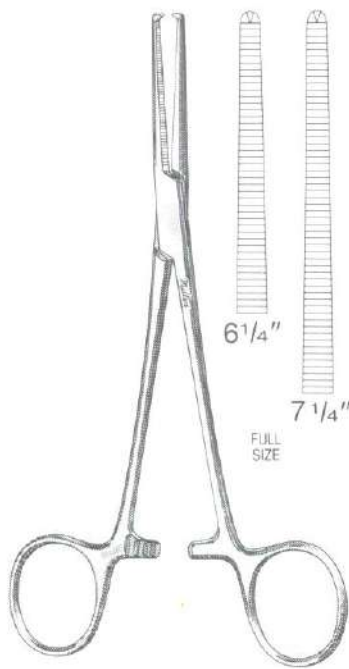

7-150 to 7-157

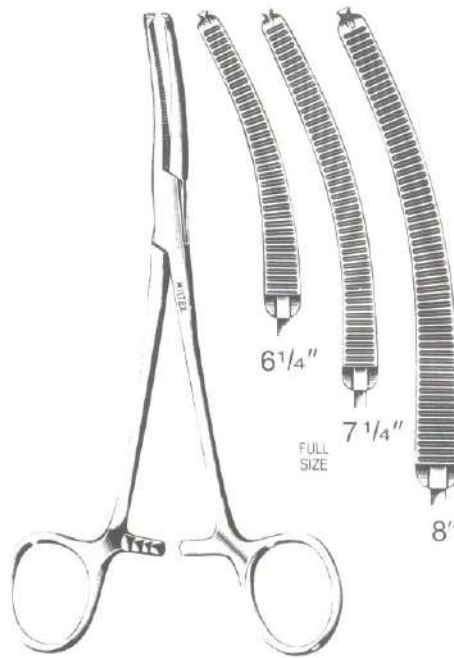

7-160 to 7-167

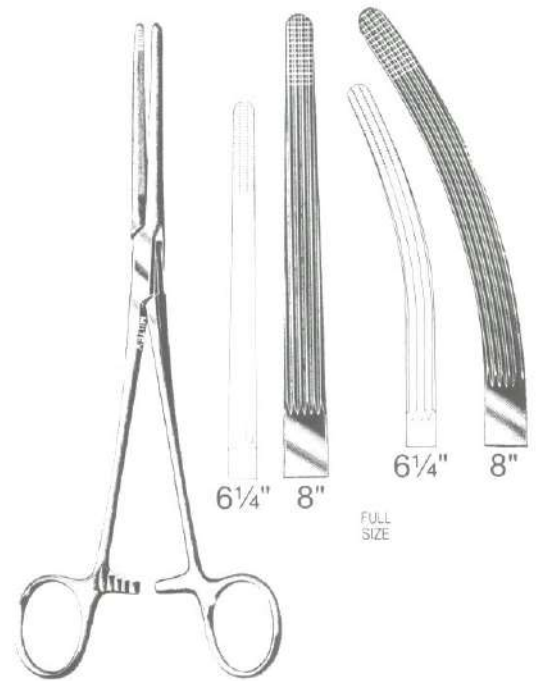

7-170 to 7-182

ROCHESTER OCHSNER FORCEPS, 1 x 2 TEETH

Straight	Length	Curved
7-150	6 1/4" (15.9 cm)	7-160
7-152	7 1/4" (18.4 cm)	7-162
7-154	8" (20.3 cm)	7-164
7-156	9" (22.9 cm)	7-166
7-157	10" (25.4 cm)	7-167

- 7-170 ROCHESTER CARMALT Forceps 6 1/4" (15.9 cm), straight
- 7-172 ROCHESTER CARMALT Forceps 6 1/4" (15.9 cm), curved
- 7-180 ROCHESTER CARMALT Forceps 8" (20.3 cm), straight
- 7-182 ROCHESTER CARMALT Forceps 8" (20.3 cm), straight

- 7-190 MICULICZ Hemostatic Forceps 8" (20.3 cm), slightly curved, 1 x 2 teeth

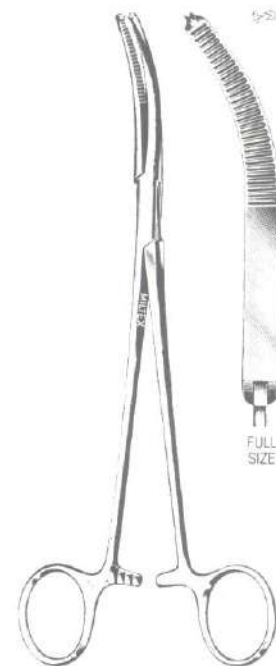

7-190

Hemostatic Forceps



30-1700

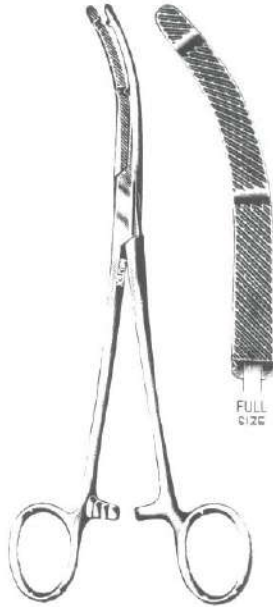

30-1710
30-1715

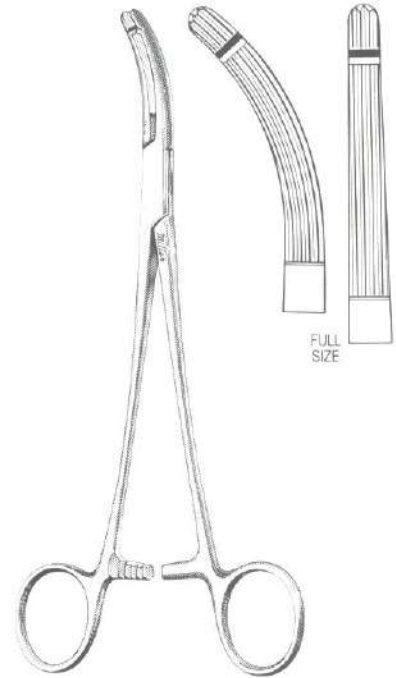

30-1716
30-1718

- 30-1700 HEANEY Forceps 8¼" (21 cm), heavy pattern, single tooth, curved
- 30-1710 HEANEY Forceps 8¼" (21 cm), heavy pattern, double tooth, curved
- 30-1715 HEANEY Forceps 9¾" (24.8 cm), extra heavy pattern, double tooth, curved
- 30-1716 HEANEY-BALLENTINE Forceps 8¼" (21 cm), longitudinal serrations, single tooth, curved
- 30-1718 BALLENTINE Forceps 8½" (21.6 cm), longitudinal serrations, single tooth, straight
- 30-1720 GARLAND Forceps 8¼" (21 cm), longitudinal serrations, single tooth, angled on flat

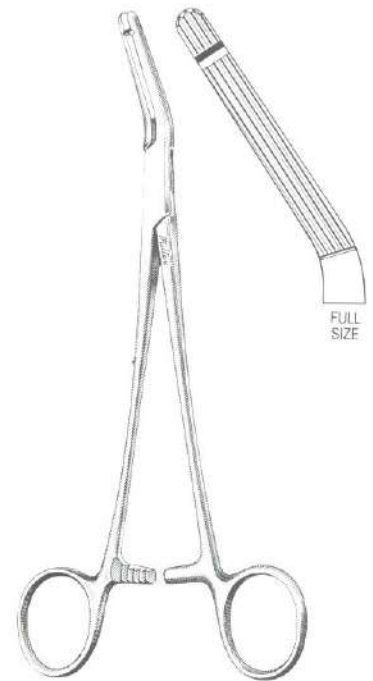

30-1720



30-1730

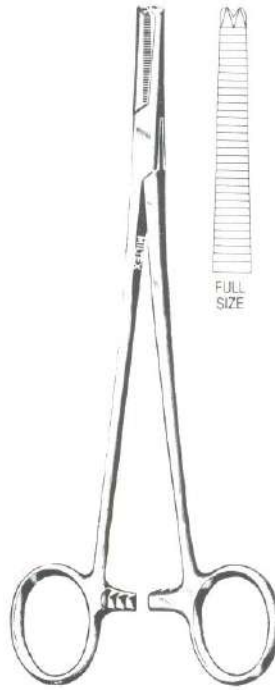

30-1735



30-1740

- 30-1730 LONG Forceps 7½" (19.1 cm), longitudinal serrations, 1 x 2 teeth, curved
- 30-1735 PHANEUF Forceps 8" (20.3 cm), horizontal serrated jaws, 1 x 2 teeth, straight
- 30-1740 PHANEUF Forceps 8" (20.3 cm), horizontal serrated jaws, 1 x 2 teeth, angled on flat
- 30-1805 PEAN Forceps 9" (22.9 cm), curved, with longitudinal serrations
- 30-1815 PEAN Forceps 10¼" (26 cm), curved, with longitudinal serrations

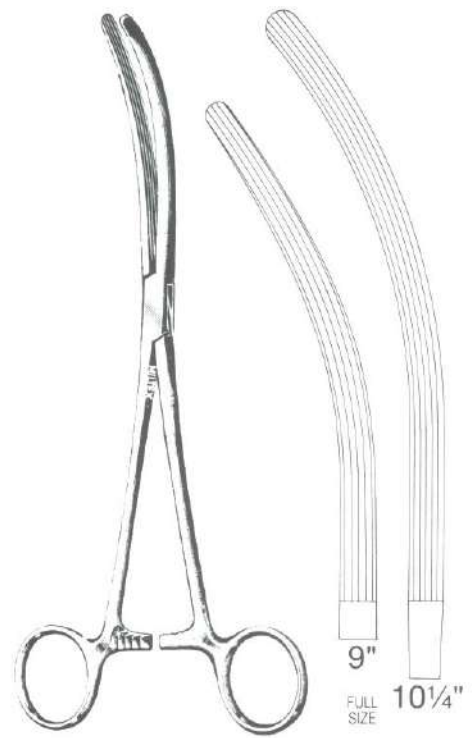

30-1805
30-1815

Hemostatic Forceps



29-280



29-282

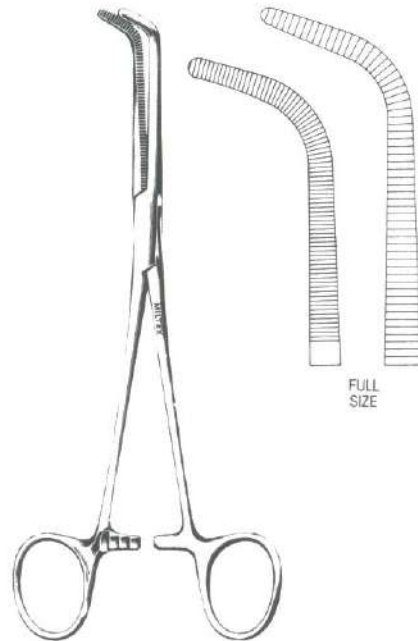

7-200
7-202

FULL
SIZE

- 29-280 WERTHEIM Pedicle Clamp 9³/₄" (24.8 cm), curved jaws 2" (5.1 cm) long
- 29-282 WERTHEIM-CULLEN Pedicle Clamp 8¹/₂" (21.6 cm), right angle jaws 2" (5.1 cm) long
- 7-200 MIXTER Forceps 6¹/₄" (15.9 cm), fully curved
- 7-202 MIXTER Forceps 7¹/₄" (18.4 cm), fully curved
- 7-206 MIXTER Forceps 9" (22.9 cm), fully curved

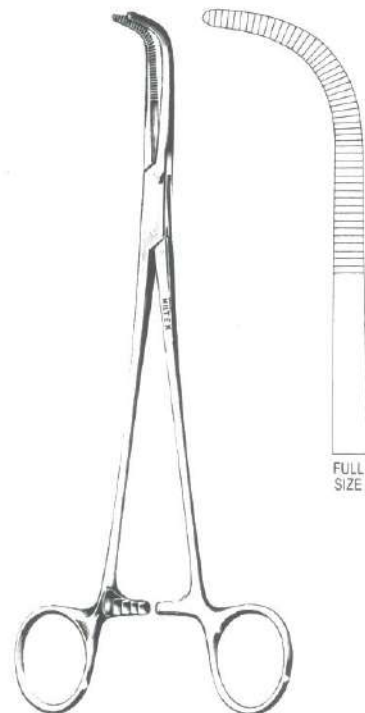

7-206

FULL
SIZE

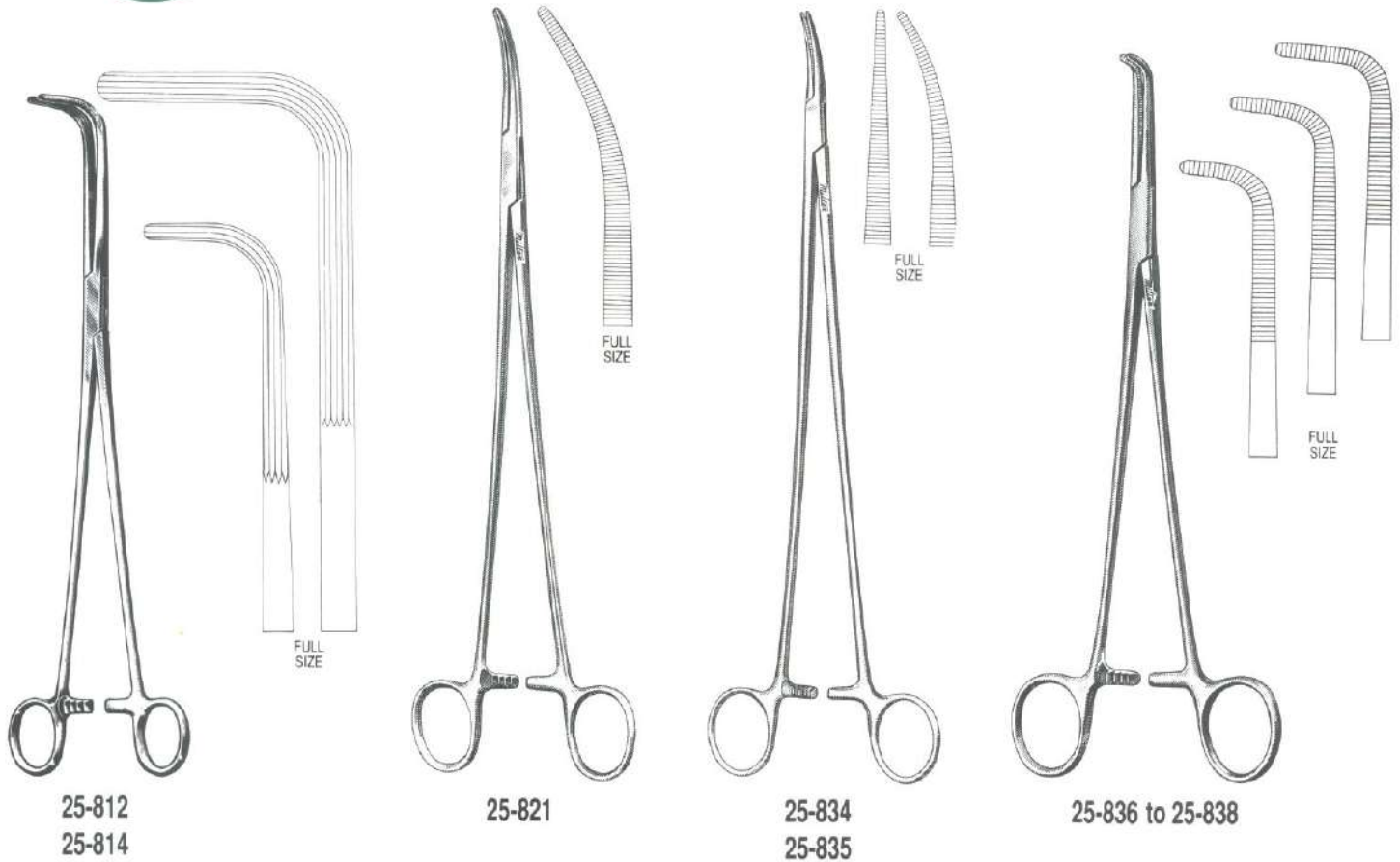

- 25-812 MIXTER Forceps 9" (22.9 cm), right angle jaws, longitudinal serrations
- 25-814 MIXTER Forceps 11" (27.9 cm), right angle jaws, longitudinal serrations
- 25-821 MILTEX Forceps 11" (27.9 cm), a delicate light-weight instrument with fine serrated 45 mm long jaws
- 25-834 BRIDGE Forceps 11" (27.9 cm), straight, very delicate
- 25-835 BRIDGE Forceps 11" (27.9 cm), curved, very delicate
- 25-836 KANTROWITZ Forceps 7½" (19.1 cm), delicate right angle jaws
- 25-837 KANTROWITZ Forceps 9½" (24.1 cm), delicate right angle jaws
- 25-838 KANTROWITZ Forceps 11" (27.9 cm), delicate right angle jaws
- 25-840 FINOCHIETTO Forceps 9" (22.9 cm), slightly curved jaws



Hemostatic Forceps



FULL SIZE

7-210

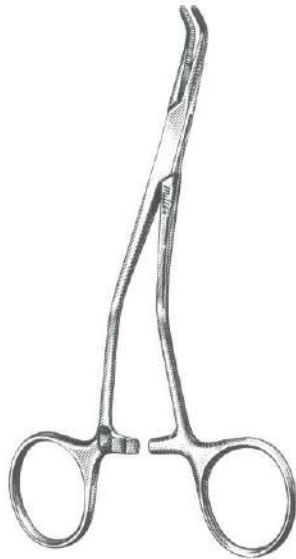

7-210A



FULL SIZE

14-46

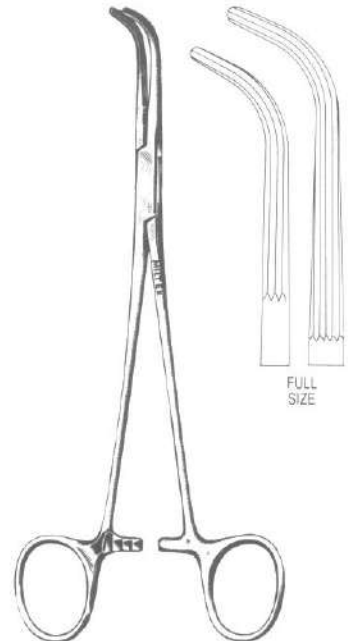

FULL SIZE

14-48
14-49

- 7-210** Baby MIXTER Forceps 5¼" (13.3 cm), fully curved, extra delicate
- 7-210A** MIXTER Forceps, Lee modif. 5¼" (13.3 cm), curved jaws and angled shanks, delicate
- 14-46** LOWER Forceps 7" (17.8 cm)
- 14-48** LAHEY Forceps 7½" (19.1cm)
- 14-49** LAHEY Forceps 9" (22.9 cm)
- 14-50** MOYNIHAN Forceps 8½" (21.6 cm)

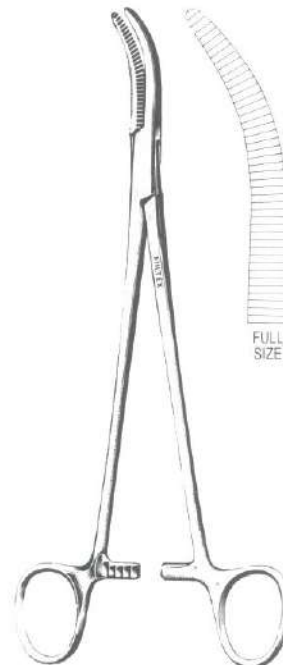

FULL SIZE

14-50

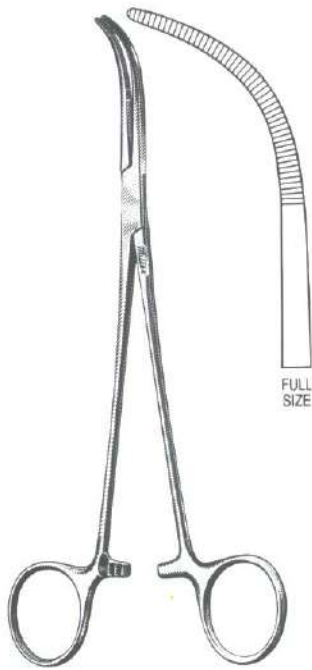

14-51



14-52

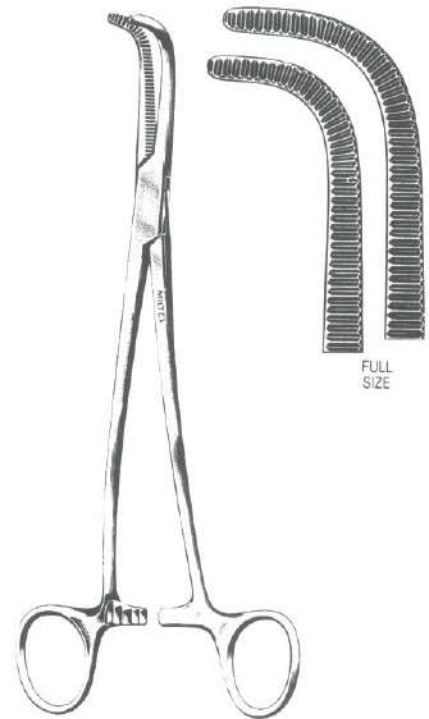

14-56

- 14-51 GREEN Forceps 8½" (21.6 cm), delicate
- 14-52 JOHNS HOPKINS Forceps 8" (20.3 cm)
- 14-56 GRAY Forceps 9" (22.9 cm), serrated, set of two
- 14-62 SHALLCROSS Forceps 7" (17.8 cm)

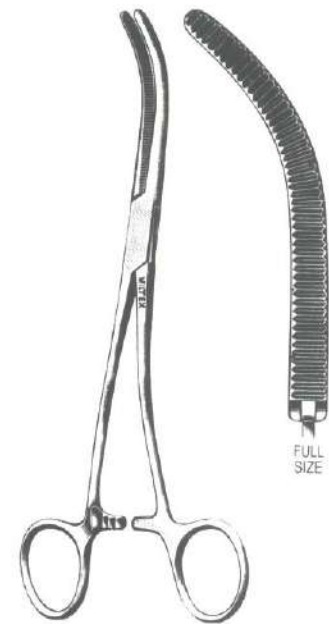

14-62

Hemostatic Forceps



22-660

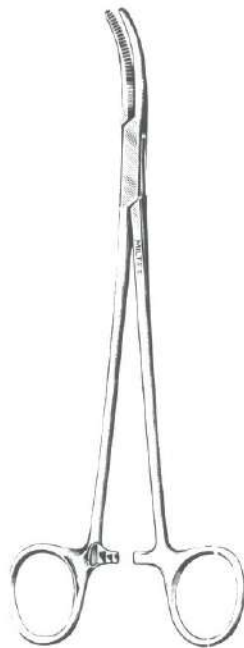

22-662



22-666



22-668

- 22-660 SCHNIDT Hemostatic Forceps 7½" (19.1 cm), slight curve, open ring
- 22-662 SCHNIDT Hemostatic Forceps 7½" (19.1 cm), slight curve, closed rings
- 22-666 SAWTELL Hemostatic Forceps 7½" (19.1 cm), full curve, open ring
- 22-668 SAWTELL Hemostatic Forceps 7½" (19.1 cm), full curve, closed rings
- 7-220 PENNINGTON Hemostatic Forceps 6" (15.2 cm)

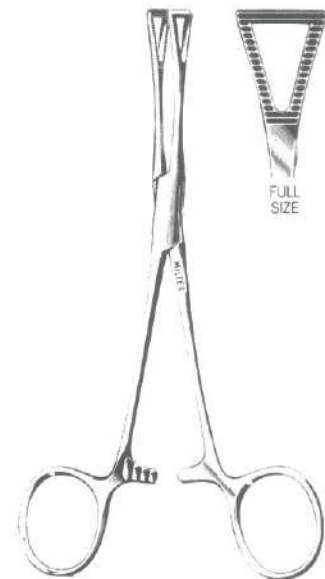

7-220



14-66

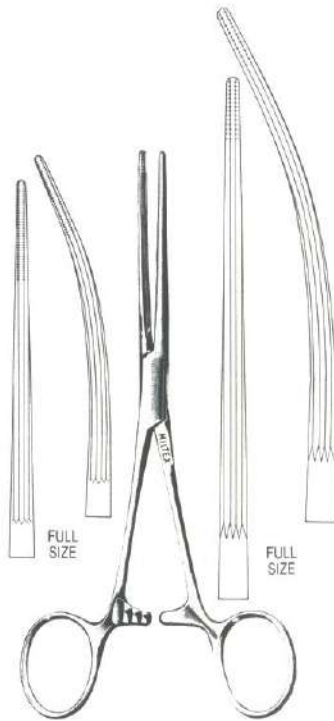

7-230 to 7-236

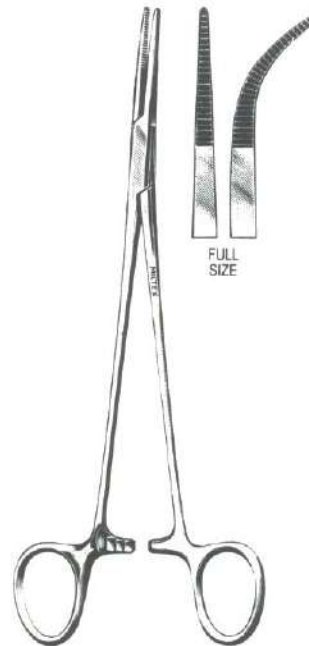

7-240
7-242

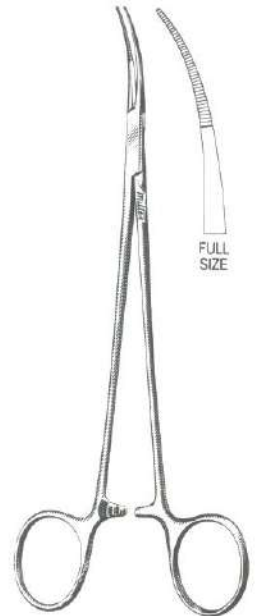

17-2603

- 14-66 LOVELACE Gall Bladder Forceps 7¼" (18.4 cm), angular, 1"(2.5 cm) wide jaws
- 7-230 BAINBRIDGE Forceps 6" (15.2 cm), straight, longitudinal serrations with cross tip serrations
- 7-232 BAINBRIDGE Forceps 6" (15.2 cm), curved, longitudinal serrations with cross tip serrations
- 7-234 BAINBRIDGE Forceps 7¼" (18.4 cm), straight, longitudinal serrations with cross tip serrations
- 7-236 BAINBRIDGE Forceps 7¼" (18.4cm), curved, longitudinal serrations with cross tip serrations
- 7-240 ADSON Hemostatic Forceps 7¼" (18.4 cm), straight
- 7-242 ADSON Hemostatic Forceps 7¼" (18.4 cm), curved
- 17-2603 JACOBSON Hemostatic Forceps 7" (17.8 cm), curved, extremely delicate
- 7-250 MOSQUITO Hemostatic Forceps 8¼" (21cm), straight, delicate
- 7-252 MOSQUITO Hemostatic Forceps 8¼" (21cm), curved, delicate
- 7-254 MOSQUITO Hemostatic Forceps 8¼" (21cm), right angle, delicate



7-250 to 7-254

Hemostatic Forceps

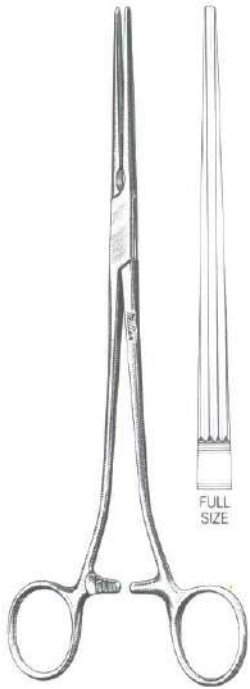

16-99

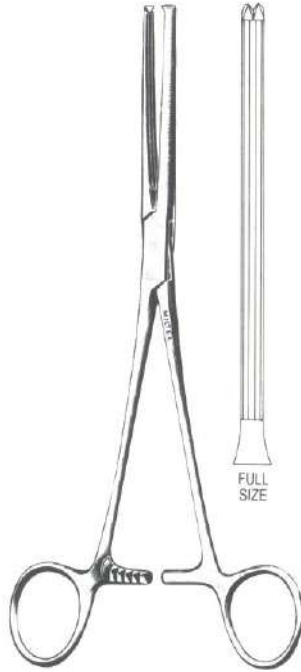

16-100



16-102

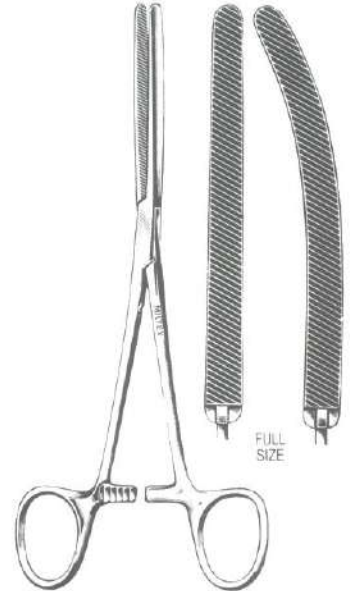

16-108
16-110

- 16-99 DENNIS Clamp 9" (22.9 cm), longitudinal serrations
- 16-100 ALLEN Clamp 8" (20.3 cm), longitudinal serrations with 1 x 2 teeth
- 16-102 Baby ALLEN Clamp 6½" (16.5 cm), delicate, longitudinal serrations with 1 x 2 teeth
- 16-108 Baby DOYEN Forceps 6½" (16.5 cm), straight, flexible blades with diagonal serrations
- 16-110 Baby DOYEN Forceps 6½" (16.5 cm), curved, flexible blades with diagonal serrations
- 16-120 KOCHER Forceps 10½" (26.7 cm), straight, longitudinal serrations
- 16-122 KOCHER Forceps 10½" (26.7 cm), curved, longitudinal serrations

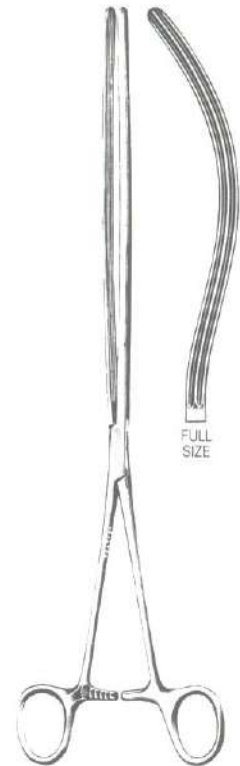

16-120
16-122

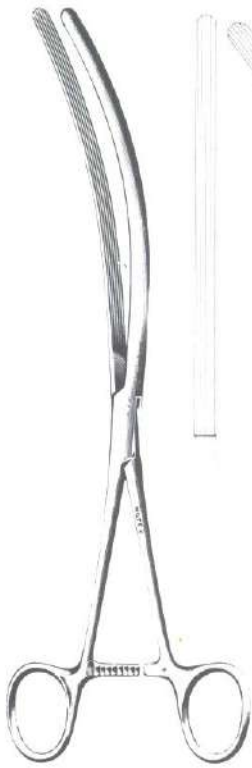

16-130
16-132

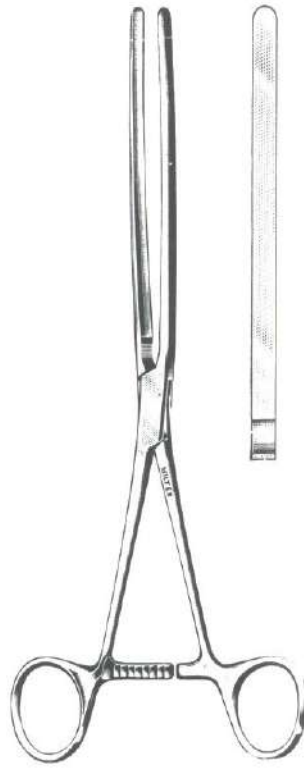

16-140



16-160
16-162

- 16-130 MAYO-ROBSON Forceps 10" (25.4 cm), straight, longitudinal serrations
- 16-132 MAYO-ROBSON Forceps 10" (25.4 cm), curved, longitudinal serrations
- 16-140 SCUDDER Forceps 9½" (24.1 cm), straight, smooth solid blades
- 16-160 DOYEN Forceps 9" (22.9 cm), straight, flexible blades with longitudinal serrations
- 16-162 DOYEN Forceps 9" (22.9 cm), curved, flexible blades with longitudinal serrations
- 7-255 GEMINI-MIXTER Forceps 5½" (14 cm), delicate, full curved jaws
- 7-256 GEMINI-MIXTER Forceps 7" (17.8 cm), delicate, full curved jaws
- 7-257 GEMINI-MIXTER Forceps 8" (20.3 cm), delicate, full curved jaws
- 7-258 GEMINI-MIXTER Forceps 9" (22.9 cm), delicate, full curved jaws
- 7-259 GEMINI-MIXTER Forceps 11" (27.9 cm), delicate, full curved jaws

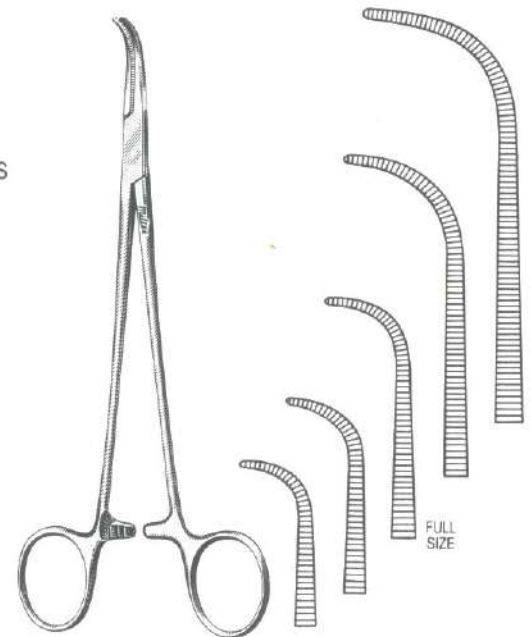

7-255 to 7-259

Hemostatic Forceps



25-780 to 25-786



FULL
SIZE



25-800

FULL
SIZE

- 25-780 RUMEL Forceps 9" (22.9 cm), slight curve, 2 $\frac{3}{8}$ " (6.1 cm), long jaws
- 25-782 RUMEL Forceps 9" (22.9 cm), medium curve, 2 $\frac{3}{8}$ " (6.1 cm), long jaws
- 25-784 RUMEL Forceps 9" (22.9 cm), full curve, 2 $\frac{3}{8}$ " (6.1 cm), long jaws
- 25-786 RUMEL Forceps 9" (22.9 cm), angular, 2 $\frac{3}{8}$ " (6.1 cm), long jaws

- 25-800 SAROT Artery Forceps 9 $\frac{1}{2}$ " (24.1 cm), with 2 $\frac{1}{2}$ " (6.4 cm) long jaws

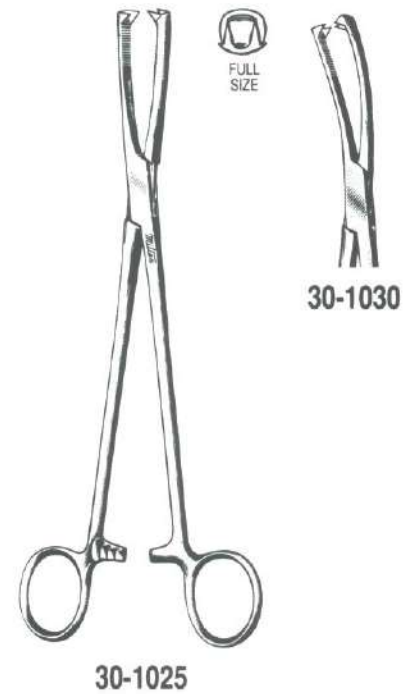
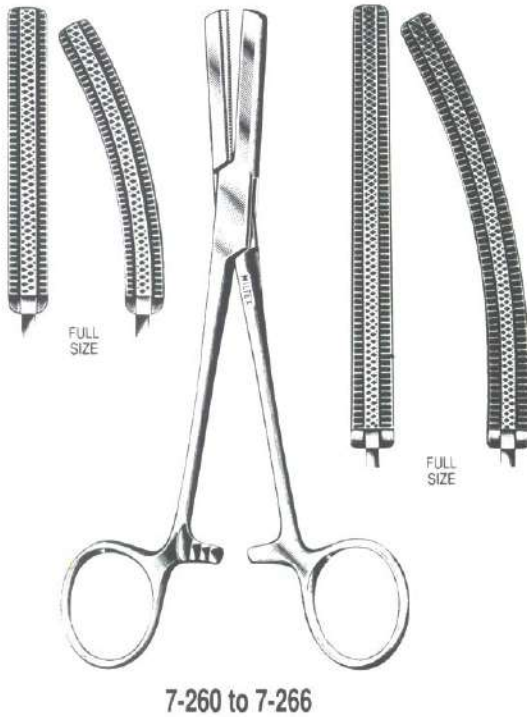

- 7-260** FERGUSON Angiotribe Forceps 6½" (16.5 cm), straight
- 7-262** FERGUSON Angiotribe Forceps 6½" (16.5 cm), curved
- 7-264** FERGUSON Angiotribe Forceps 7½" (19.1 cm), straight
- 7-266** FERGUSON Angiotribe Forceps 7½" (19.1 cm), curved
- 30-1025** JACOBS Forceps 8½" (21.6 cm), straight, serrated jaws, 2 x 2 teeth
- 30-1030** JACOBS Forceps 8½" (21.6 cm), curved sideways, serrated jaws, 2 x 2 teeth
- 30-1050-6** MUSEUX Forceps 9½" (24.1 cm), straight, 2 x 2 teeth, 6 mm wide jaws
- 30-1050-8** MUSEUX Forceps 9½" (24.1 cm), straight, 2 x 2 teeth, 8 mm wide jaws
- 30-1050-10** MUSEUX Forceps 9½" (24.1 cm), straight, 2 x 2 teeth, 10 mm wide jaws





7-280 to 7-298

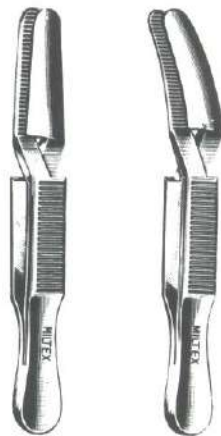

7-300 to 7-305

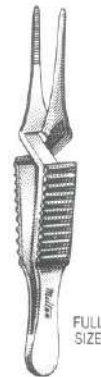

7-310
FULL
SIZE



7-315
FULL
SIZE

- | | |
|-------|---|
| 7-280 | JOHNS HOPKINS Bulldog Clamp 1½" (3.8 cm), straight |
| 7-282 | JOHNS HOPKINS Bulldog Clamp 2" (5 cm), straight |
| 7-284 | JOHNS HOPKINS Bulldog Clamp 2½" (6.3 cm), straight |
| 7-286 | JOHNS HOPKINS Bulldog Clamp 3" (7.6 cm), straight |
| 7-288 | JOHNS HOPKINS Bulldog Clamp 3½" (8.9 cm), straight |
| 7-290 | JOHNS HOPKINS Bulldog Clamp 1½" (3.8 cm), curved |
| 7-292 | JOHNS HOPKINS Bulldog Clamp 2" (5 cm), curved |
| 7-294 | JOHNS HOPKINS Bulldog Clamp 2½" (6.3 cm), curved |
| 7-296 | JOHNS HOPKINS Bulldog Clamp 3" (7.6 cm), curved |
| 7-298 | JOHNS HOPKINS Bulldog Clamp 3½" (8.9 cm), curved |
| 7-300 | DIEFFENBACH Serrefine 2¼" (5.7 cm), straight |
| 7-302 | DIEFFENBACH Serrefine 2¼" (5.7 cm), curved |
| 7-304 | DIEFFENBACH Serrefine 1½" (3.8 cm), straight |
| 7-305 | DIEFFENBACH Serrefine 1½" (3.8 cm), curved |
| 7-310 | DIETRICH Micro Bulldog Clamp 1⅞" (4.7 cm), straight jaws
8 mm x 1.2 mm |
| 7-315 | DIETRICH Micro Bulldog Clamp 1¾" (4.4 cm), angled jaws
8 mm x 1.2 mm |

For Atraumatic Bulldog clamps see pages 374 - 376



7-500
7-501

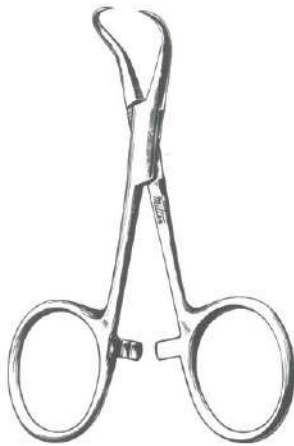

7-504



7-506

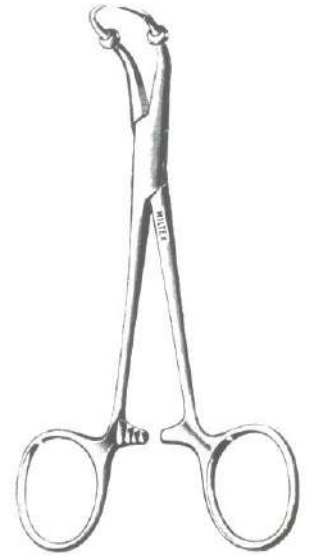

7-510

- 7-500 JONES Towel Clamp 3½" (8.9 cm), standard size
- 7-501 JONES Towel Clamp 2¼" (5.7 cm), lightweight
- 7-504 BACKHAUS Towel Clamp 3½" (8.9 cm)
- 7-506 BACKHAUS Towel Clamp 5¼" (13.3 cm)
- 7-510 ROEDER Towel Clamp 5¼" (13.3 cm), with ball stops
- 7-514 LORNA Non-Perforating Towel Clamp 3½" (8.9 cm)
- 7-515 LORNA Non-Perforating Towel Clamp 5¼" (13.3 cm)

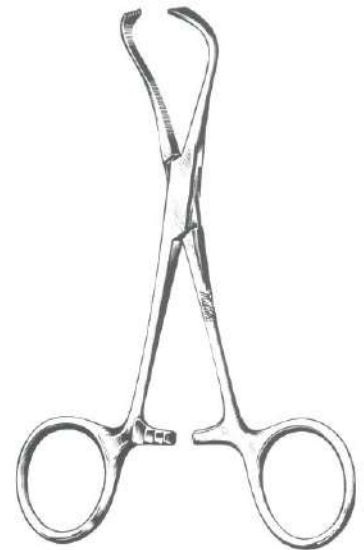

7-514
7-515



7-600 to 7-606



FULL
SIZE



7-610 to 7-616



FULL
SIZE

FOERSTER SPONGE FORCEPS

- | | |
|---------|--|
| 7-600 | 9½" (24.1 cm), straight, serrated jaws |
| 7-602 | 9½" (24.1 cm), straight, smooth jaws |
| 7-604 | 7" (17.8 cm), straight, serrated jaws |
| 7-606 | 7" (17.8 cm), straight, smooth jaws |
| 7-610 | 9½" (24.1 cm), curved, serrated jaws |
| 7-612 | 9½" (24.1 cm), curved, smooth jaws |
| 7-614 | 7" (17.8 cm), curved, serrated jaws |
| 7-616 | 7" (17.8 cm), curved, smooth jaws |
| 30-2505 | KELLY Sponge Forceps 12½" (31.8 cm), serrated ring jaws, slightly curved |

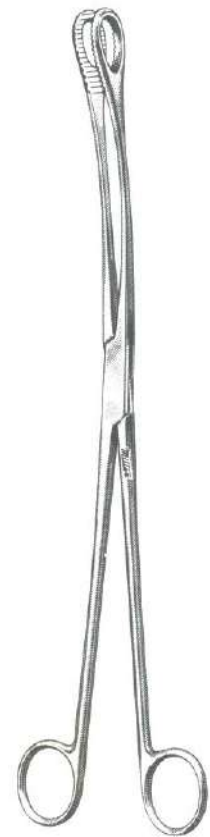

30-2505

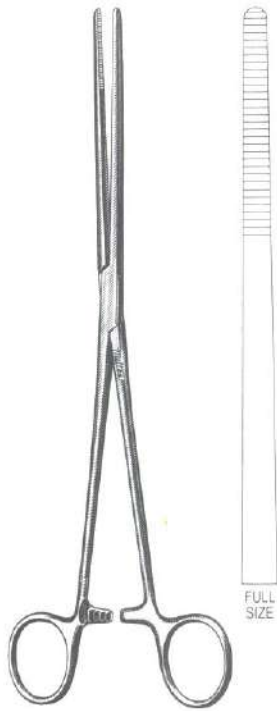

7-620



FULL
SIZE

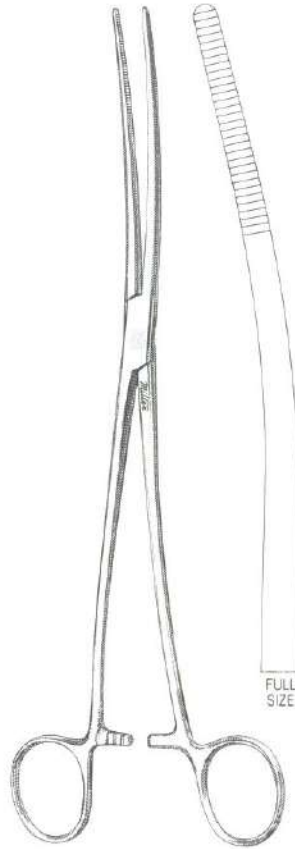

7-622

FULL
SIZE

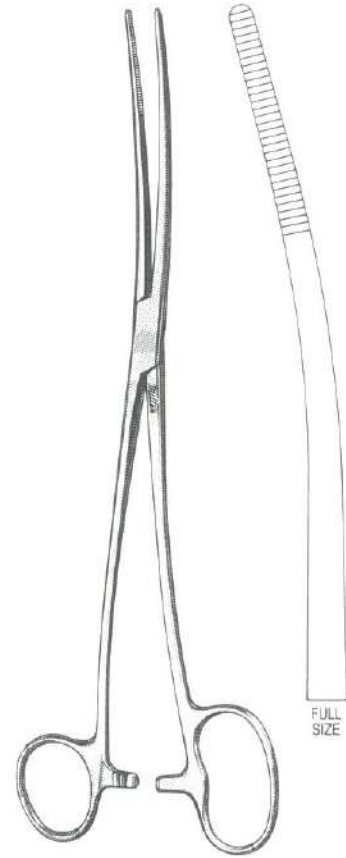

7-624

FULL
SIZE

- 7-620 BOZEMAN Sponge Forceps 10½" (26.7 cm), straight
- 7-622 BOZEMAN Sponge Forceps 10½" (26.7 cm), double curved
- 7-624 BOZEMAN Sponge Forceps 10½" (26.7 cm), double curved,
with one large finger ring
- 7-630 FLETCHER Sponge Forceps 9½" (24.1 cm), straight
- 7-632 FLETCHER Sponge Forceps 9½" (24.1 cm), curved

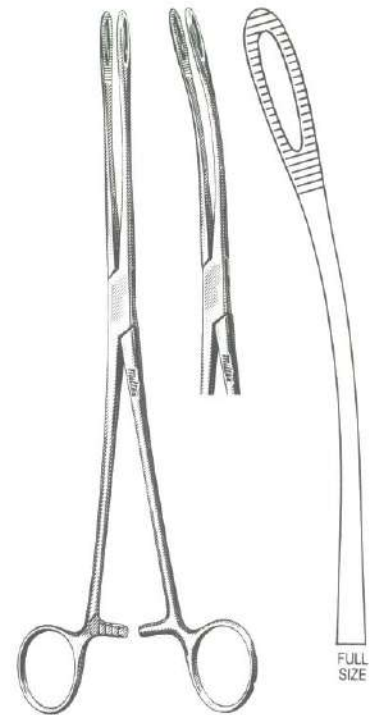

7-630

7-632

FULL
SIZE



8-2



8-4



8-6

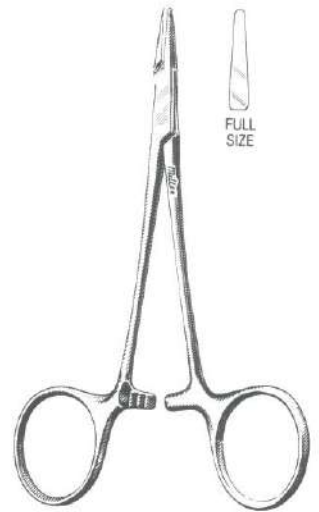

8-7

8-2 COLLIER Needle Holder 5" (12.7 cm), fenestrated jaws

8-4 DERF Needle Holder 4¾" (12.1 cm)

8-6 WEBSTER Needle Holder 5" (12.7 cm), delicate, smooth jaws, standard pattern

8-7 WEBSTER Needle Holder 4¾" (12.1 cm), extra delicate, smooth jaws

8-8 HALSEY Needle Holder 5" (12.7 cm), smooth jaws

8D-36 HALSEY Needle Holder 5" (12.7 cm), serrated jaws

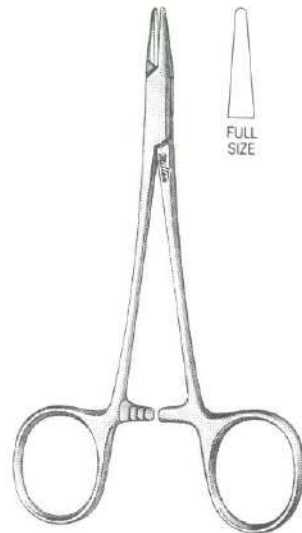

8-8

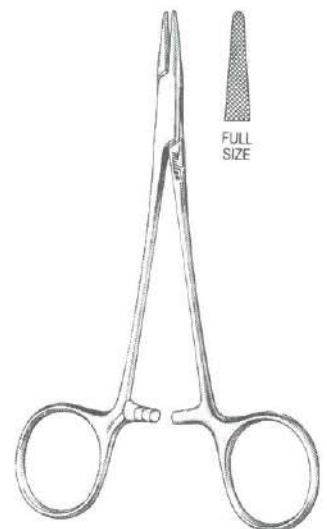

8D-36



8-10



8-12

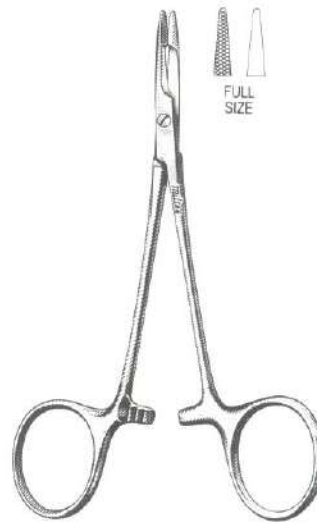

8-14
8-14A



8-15 to 8-17

- 8-10 ABBEY Needle Holder 5" (12.7 cm)
- 8-12 NEIVERT Needle Holder 5" (12.7 cm), one offset ring

OLSEN-HEGAR NEEDLE HOLDERS
combined with Suture Scissors

- 8-14 4¾" (12.1 cm), extra delicate pattern, serrated jaws
- 8-14A 4¾" (12.1 cm), extra delicate pattern, smooth jaws
- 8-15 5½" (14 cm), serrated jaws
- 8-16 6½" (16.5 cm), serrated jaws
- 8-17 7¼" (18.4 cm), serrated jaws

- 8-20 CONVERSE Needle Holder 4¼" (10.8 cm), longitudinal serrations, large finger rings



8-20



8-22
8-23



8-26



8-28

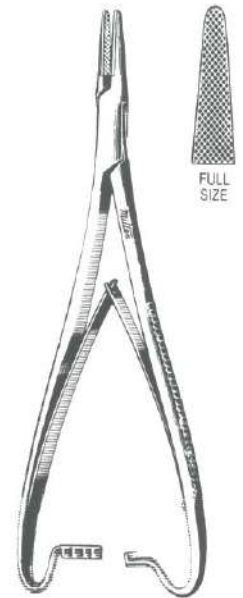

8-30
8-32

- 8-22 BROWN Needle Holder 5¼" (13.3 cm), convex jaws, fine serrations
- 8-23 BROWN Needle Holder 6¾" (17.1 cm), convex jaws, fine serrations
- 8-26 BOYNTON Needle Holder 5" (12.7 cm), delicate
- 8-28 MATHIEU Needle Holder 5½" (14 cm), with spring handles
- 8-30 MATHIEU Needle Holder 6¼" (15.9 cm), with spring handles
- 8-32 MATHIEU Needle Holder 7½" (19.1 cm), with spring handles
- 8-40 BAUMGARTNER Needle Holder 5½" (14 cm)



8-40



8-42 to 8-48



8-130

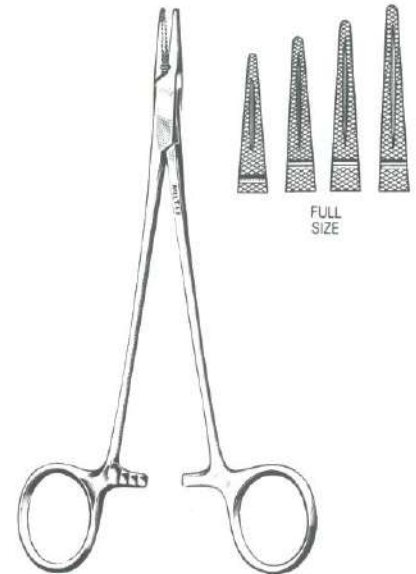

8-50 to 8-53

- 8-42 MAYO-HEGAR Needle Holder 5" (12.7 cm)
- 8-44 MAYO-HEGAR Needle Holder 6" (15.2 cm)
- 8-46 MAYO-HEGAR Needle Holder 7" (17.8 cm)
- 8-48 MAYO-HEGAR Needle Holder 8" (20.3 cm)
- 8-130 MAYO-HEGAR (MASSON) Needle Holder 10½" (26.7 cm)
- 8-50 CRILE-WOOD Needle Holder 6" (15.2 cm)
- 8-51 CRILE-WOOD Needle Holder 7" (17.8 cm)
- 8-52 CRILE-WOOD Needle Holder 8" (20.3 cm)
- 8-53 CRILE-WOOD Needle Holder 9" (22.9 cm)

GILLIES-SHEEHAN Needle Holders combined with Suture Scissors, one fenestrated jaw and one angled finger ring

- 8-58 6½" (16.5 cm), straight
- 8-59 6½" (16.5 cm), curved

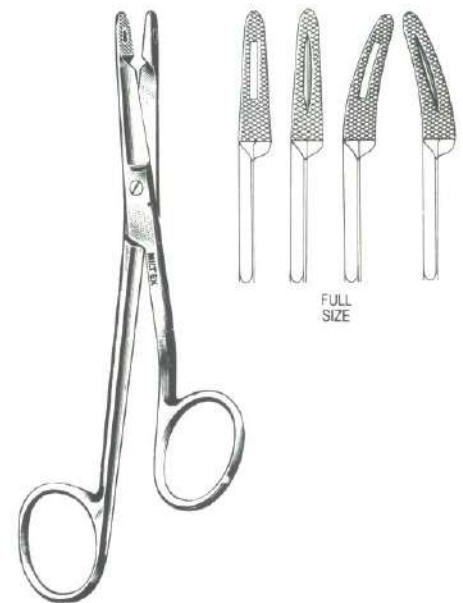

8-58
8-59



8-70

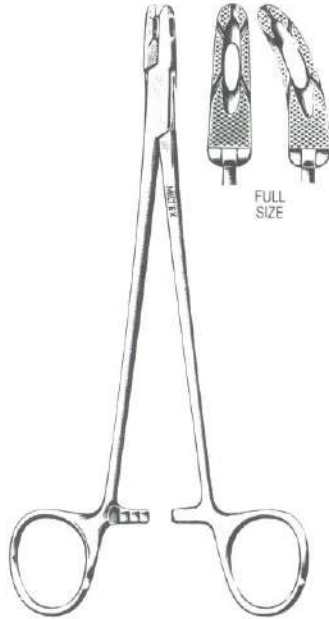

8-74
8-76



8-80



8-84

- 8-70 ADSON Needle Holder 7" (17.8 cm), fenestrated jaws
- 8-74 METZENBAUM Needle Holder 7¼" (18.4 cm), straight, fenestrated jaws
- 8-76 METZENBAUM Needle Holder 7¼" (18.4 cm), curved, fenestrated jaws
- 8-80 NEW ORLEANS Needle Holder 7" (17.8 cm)
- 8-84 M.G.H. Needle Holder 7" (17.8 cm)
- 8-94 CRILE Needle Holder 6" (15.2 cm)



8-94



- 8-96** SAROT Needle Holder 7 1/8" (18.1 cm), light model
- 8-114** SAROT Needle Holder 10 1/2" (26.7 cm)
- 8-100** HEANEY Needle Holder 8 1/2" (21.6 cm), curved jaws
- 8-102** STRATTE Needle Holder 9" (22.9 cm), double curved jaws and bent shanks



8-122



8-134

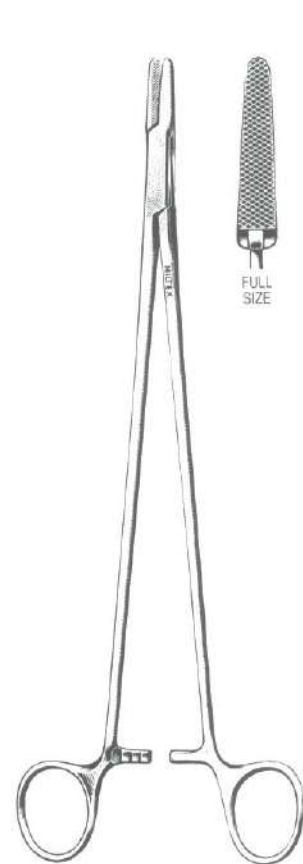

8-136

- 8-122 FINOCHIETTO Needle Holder 10½" (26.7 cm), angled jaws
- 8-134 WANGENSTEEN Needle Holder 10¾" (27.3 cm), long jaws
- 8-136 WANGENSTEEN Needle Holder 10½" (26.7 cm), short jaws



FULL
SIZE

17-1000



FULL
SIZE

17-980
17-1010



FULL
SIZE

17-1020

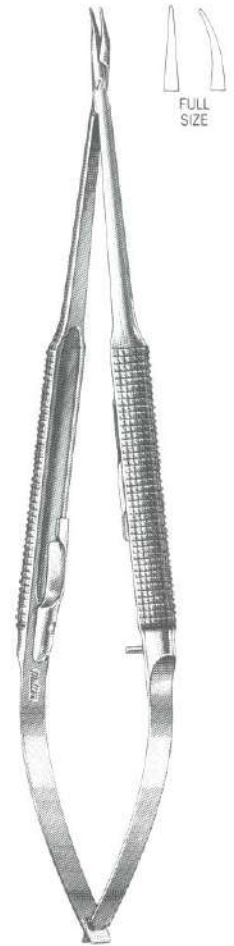

FULL
SIZE

17-1024
17-1025

MILTEX Micro Surgery Needle Holders
with round handles, 0.6 mm tips

- | | |
|----------------|---|
| 17-1000 | 5¼" (13.3 cm), curved jaws |
| 17-980 | 7⅞" (18.1 cm), straight jaws |
| 17-1010 | 7⅞" (18.1 cm), curved jaws |
| 17-1020 | 5¼" (13.3 cm), curved jaws, with lock |
| 17-1024 | 7⅞" (18.1 cm), straight jaws, with lock |
| 17-1025 | 7⅞" (18.1 cm), curved jaws, with lock |

Needle Holders



18-1800



18-1810

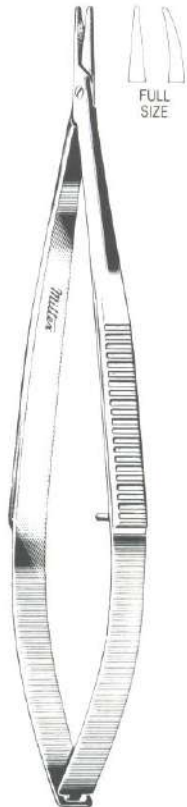

18-1820
18-1824

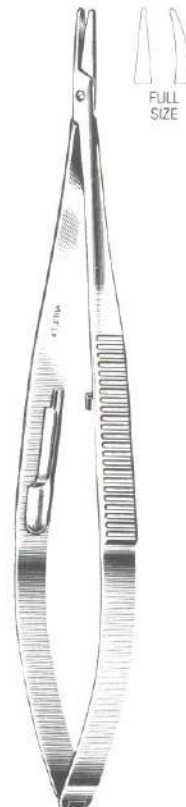

18-1828
18-1832

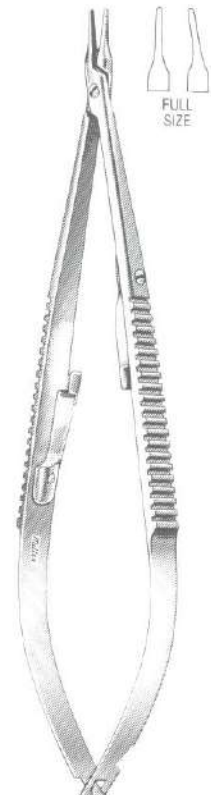

18-1831
18-1833

- 18-1800 KALT Needle Holder 5¼" (13.3 cm), standard model, delicate jaws
- 18-1810 GREEN Needle Holder and Suturing Forceps 4¼" (10.8 cm), angled jaws, double end
- 18-1820 CASTROVIEJO Needle Holder 5½" (14 cm), straight, without lock
- 18-1824 CASTROVIEJO Needle Holder 5½" (14 cm), curved, without lock
- 18-1828 CASTROVIEJO Needle Holder 5½" (14 cm), straight, with lock
- 18-1832 CASTROVIEJO Needle Holder 5½" (14 cm), curved, with lock
- 18-1831 CASTROVIEJO Needle Holder 5½" (14 cm), straight, extra delicate jaws, with lock
- 18-1833 CASTROVIEJO Needle Holder 5½" (14 cm), curved, extra delicate jaws, with lock

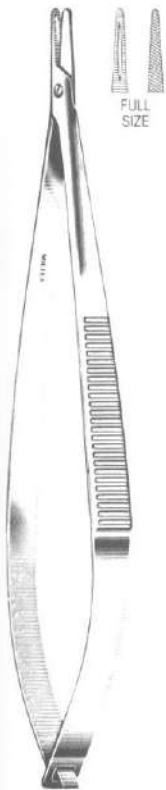

18-1834

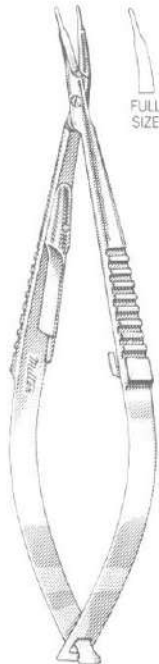

18-1837

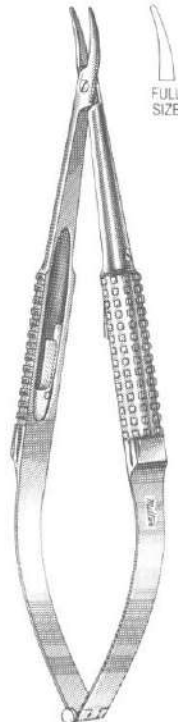

18-1838
18-1839

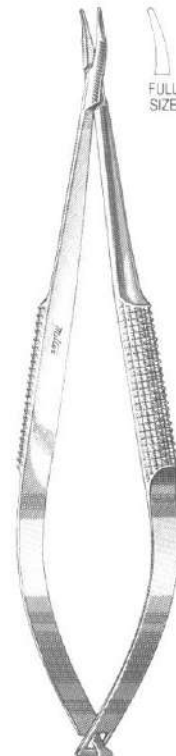

18-1840



18-1858

- 18-1834 PATON Needle Holder 4½" (11.4 cm), straight, without lock
- 18-1837 McPHERSON Needle Holder for microsurgery 4" (10.2 cm), curved, smooth tapered jaws, with lock
- 18-1838 BARRAQUER Needle Holder 5" (12.7 cm), curved, without lock, 10 mm wide hollow round handles
- 18-1839 BARRAQUER Needle Holder 5" (12.7cm), curved, with lock, 10 mm wide hollow round handles
- 18-1840 BARRAQUER Needle Holder 5½" (13 cm), curved, delicate tapered jaws, 8 mm wide round handles, without lock
- 18-1858 STEVENS Needle Holder 6½" (16.5 cm), with ratchet lock

Carb-N-Sert Needle Holders



OUR TOP QUALITY LINE OF NEEDLE HOLDERS

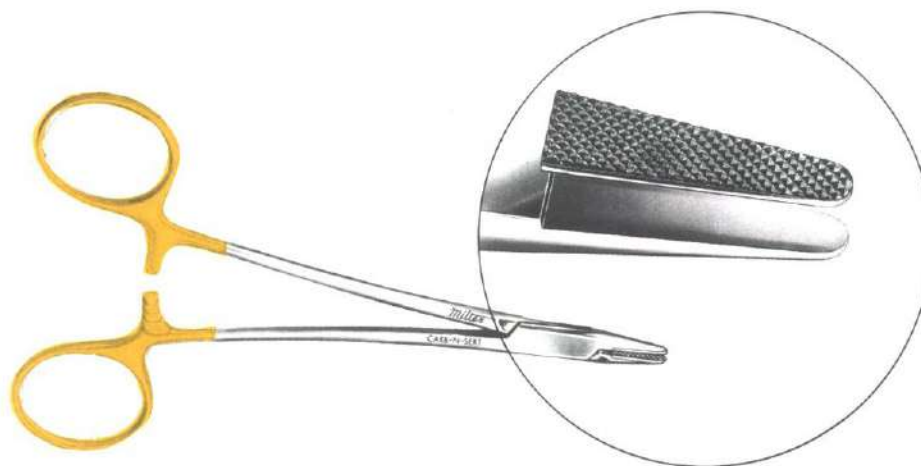

Carb-N-Sert jaws are made of tungsten carbide, the hardest steel made for surgical instruments. They are then bonded to needle holders made of the finest quality stainless steel.

- Teeth are precision milled into the tungsten carbide, forming sharp pyramid-shapes to provide a positive non-slip grip on needles and sutures.
- Carb-N-Sert jaws are custom styled with teeth ranging from 2600 p.sq. inch to 16000 p.sq. inch, according to the size of the instrument and the sizes of needles and sutures used. Some needle holder patterns are also available with smooth Carb-N-Sert jaws, designed to hold the smallest sutures in micro-surgical and plastic surgery procedures.
- The edges around the outside of the jaws are chamfered to prevent

accidental cutting of suture material when held in the jaws.

- The edges around the box lock have distinct non-catch bevels, preventing fraying of suture material.
- Finger Rings are well rounded and polished for better "feel" and prevention of finger fatigue.
- Each instrument is satin finished to reduce glare.

Gold plated finger rings identify these tungsten carbide instruments, and the Miltex catalog number has been etched on each needle holder to facilitate re-ordering.

Carb-N-Sert Needle Holders are specifically designed for precise suturing, thereby facilitating the surgeon's task.

CARB-N-SERT NEEDLE HOLDERS
with tungsten carbide inserts
insure firm holding of needles and sutures



- 8-4TC** DERF Needle Holder 4¾" (12.1 cm), serrated jaws 4000 teeth p. sq. inch
- 8-6TC** WEBSTER Needle Holder 5¼" (13.3 cm), smooth jaws, standard pattern, delicate
- 8-7TC** WEBSTER Needle Holder 4¾" (12.1 cm), smooth jaws, extra delicate
- 8-7A-TC** WEBSTER (JOHNSON) Needle Holder 4¾" (12.1 cm), serrated jaws 4000 teeth p. sq. inch, extra delicate
- 8-8TC** HALSEY Needle Holder 5" (12.7 cm), smooth jaws, standard pattern
- 8-8A-TC** HALSEY Needle Holder 5" (12.7 cm), serrated jaws 4000 teeth p. sq. inch

Carb-N-Sert Needle Holders



CARB-N-SERT NEEDLE HOLDERS
with tungsten carbide inserts
insure firm holding of needles and sutures



8-14TC
8-14A-TC



8-15TC
8-16TC
8-17TC



8-28TC



8-30TC

OLSEN-HEGAR NEEDLE HOLDERS combined with Suture Scissors

- 8-14TC** 4¾" (12.1 cm) extra delicate, serrated jaws
4000 teeth p. sq. inch
- 8-14A-TC** 4¾" (12.1 cm), extra delicate, smooth jaws
- 8-15TC** 5½" (14 cm) serrated jaws 2600 teeth p. sq. inch
- 8-16TC** 6½" (16.5 cm) serrated jaws 2600 teeth p. sq. inch
- 8-17TC** 7½" (19.1 cm) serrated jaws 2600 teeth p. sq. inch
- 8-28TC** MATHIEU Needle Holder 5½" (14 cm), serrated jaws
2600 teeth p. sq. inch
- 8-30TC** MATHIEU Needle Holder 6¼" (15.9 cm), serrated jaws
2600 teeth p. sq. inch
- 8-40TC** BAUMGARTNER Needle Holder 5½" (14 cm), serrated
jaws 4000 teeth p. sq. inch



8-40TC

Carb-N-Sert Needle Holders

CARB-N-SERT NEEDLE HOLDERS
with tungsten carbide inserts
insure firm holding of needles and sutures



8-42TC to 8-48TC



8-130TC
8-49TC

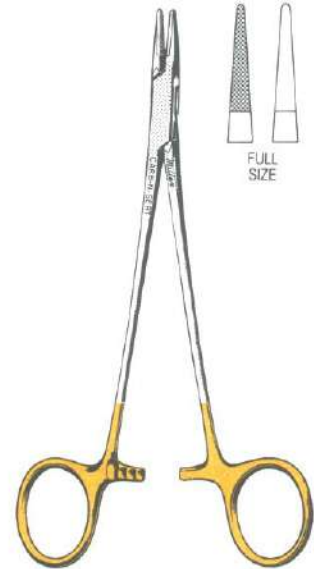

8-50TC
8-50A-TC

- 8-42TC MAYO-HEGAR Needle Holder 5" (12.7 cm), serrated jaws 2600 teeth p. sq. inch
- 8-44TC MAYO-HEGAR Needle Holder 6" (15.2 cm), serrated jaws 2600 teeth p. sq. inch
- 8-46TC MAYO-HEGAR Needle Holder 7" (17.8 cm), serrated jaws 2600 teeth p. sq. inch
- 8-48TC MAYO-HEGAR Needle Holder 8" (20.3 cm), serrated jaws 2600 teeth p. sq. inch
- 8-130TC MAYO-HEGAR (MASSON) Needle Holder 10½" (26.7 cm), serrated jaws 2600 teeth p. sq. inch
- 8-49TC MAYO-HEGAR Needle Holder 12" (30.5 cm), serrated jaws 2600 teeth p. sq. inch
- 8-50TC CRILE-WOOD Needle Holder 6" (15.2 cm), serrated jaws 4000 teeth p. sq. inch
- 8-50A-TC CRILE-WOOD Needle Holder 6" (15.2 cm), smooth jaws

Carb-N-Sert Needle Holders



CARB-N-SERT NEEDLE HOLDERS
with tungsten carbide inserts
insure firm holding of needles and sutures



- 8-51TC** CRILE-WOOD (DeBAKEY) Needle Holder 7" (17.8 cm), serrated jaws 4000 teeth p. sq. inch
- 8-52TC** CRILE-WOOD (DeBAKEY) Needle Holder 8" (20.3 cm), serrated jaws 2600 teeth p. sq. inch
- 8-53TC** CRILE-WOOD (DeBAKEY) Needle Holder 9" (22.9 cm), serrated jaws 2600 teeth p. sq. inch
- 8-55TC** CRILE-WOOD (DeBAKEY) Needle Holder 10½" (26.7 cm), serrated jaws 2600 teeth p. sq. inch
- 8-57TC** CRILE-WOOD (DeBAKEY) Needle Holder 12" (30.5 cm), serrated jaws 2600 teeth p. sq. inch

- 8-62TC** COOLEY Needle Holder 6" (15.2 cm), extra delicate, serrated jaws 4000 teeth p. sq. inch
- 8-63TC** COOLEY Needle Holder 6¾" (17.1 cm), extra delicate, serrated jaws 4000 teeth p. sq. inch

- 8-65TC** RYDER-Type Intracardiac Needle Holder 5" (12.7 cm), extra delicate, serrated jaws 4000 teeth p. sq. inch
- 8-66TC** RYDER-Type Intracardiac Needle Holder 6" (15.2 cm), extra delicate, serrated jaws 4000 teeth p. sq. inch
- 8-67TC** RYDER-Type Intracardiac Needle Holder 7" (17.8 cm), extra delicate, serrated jaws 4000 teeth p. sq. inch
- 8-69TC** RYDER-Type Intracardiac Needle Holder 9" (22.9 cm), extra delicate, serrated jaws 4000 teeth p. sq. inch

- 8-81TC** NEW ORLEANS Needle Holder 7" (17.8cm), serrated jaws 2600 teeth p. sq. inch

Carb-N-Sert Needle Holders

CARB-N-SERT NEEDLE HOLDERS
with tungsten carbide inserts
insure firm holding of needles and sutures



8-82TC
8-83TC



8-96TC
8-114TC



8-100TC



8-102TC

- 8-82TC JULIAN PATTERN Needle Holder 8¼" (21cm), straight fine tips, serrated jaws 2600 teeth p. sq. inch
- 8-83TC JULIAN PATTERN Needle Holder 8¼" (21cm), curved fine tips, serrated jaws 2600 teeth p. sq. inch
- 8-96TC SAROT Needle Holder 7¼" (18.4cm), serrated jaws 2600 teeth p. sq. inch
- 8-114TC SAROT Needle Holder 10½" (26.7cm), serrated jaws 2600 teeth p. sq. inch
- 8-100TC HEANEY Needle Holder 8½" (21.6 cm), curved, serrated jaws 2600 teeth p. sq. inch
- 8-102TC STRATTE Needle Holder 9" (22.9cm), serrated jaws 2600 teeth p. sq. inch
- 22-500TC Wire Twister 6" (15.2 cm)
- 22-502TC Wire Twister 8" (20.3 cm)



22-500TC
22-502TC

Carb-N-Sert Needle Holders



CARB-N-SERT NEEDLE HOLDERS
with tungsten carbide inserts insure firm holding of needles and sutures

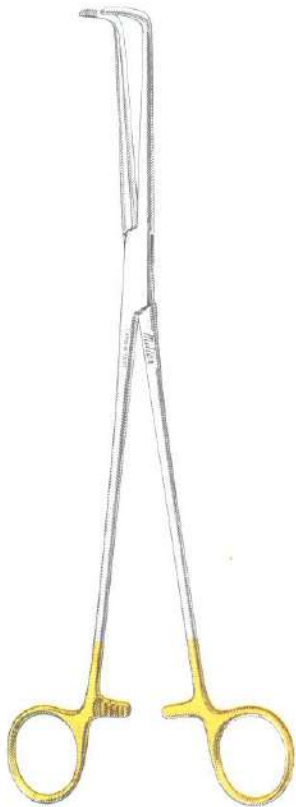

29-310TC

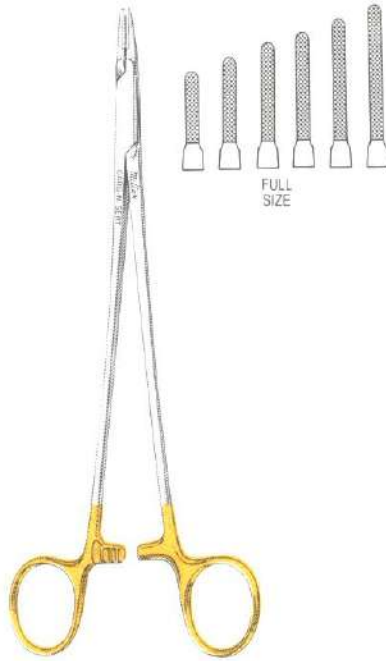

8-101TC to 107TC



8-134TC

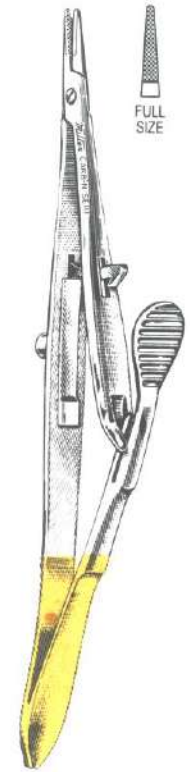

18-1800TC

- 29-310TC** BIHRLE Needle Holder/Clamp 11" (27.9 cm)
- 8-101TC** RYDER Needle Holder 5" (12.7 cm), serrated jaws 4000 teeth p. sq. inch
- 8-103TC** RYDER Needle Holder 6" (15.2 cm), serrated jaws 4000 teeth p. sq. inch
- 8-104TC** RYDER Needle Holder 7" (17.8 cm), serrated jaws 4000 teeth p. sq. inch
- 8-105TC** RYDER Needle Holder 8" (20.3 cm), serrated jaws 4000 teeth p. sq. inch
- 8-106TC** RYDER Needle Holder 9" (22.9 cm), serrated jaws 4000 teeth p. sq. inch
- 8-107TC** RYDER Needle Holder 10¼" (26 cm), serrated jaws 4000 teeth p. sq. inch
- 8-134TC** WANGENSTEEN Needle Holder 10¾" (27.3 cm), serrated jaws 2600 teeth p. sq. inch
- 18-1800TC** KALT Needle Holder 5½" (14 cm), serrated jaws 16000 teeth p. sq. inch
- 18-1816TC** MILTEX-CASTROVIEJO Needle Holder 4⅛" (10.5 cm), round handles, with lock, delicate smooth jaws

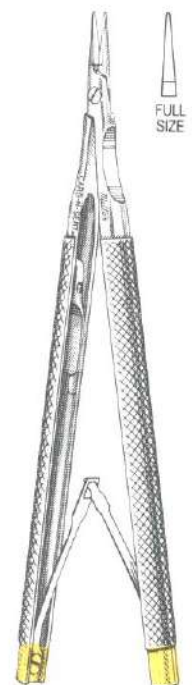

18-1816TC

CARB-N-SERT NEEDLE HOLDERS
with tungsten carbide inserts insure firm holding of needles and sutures

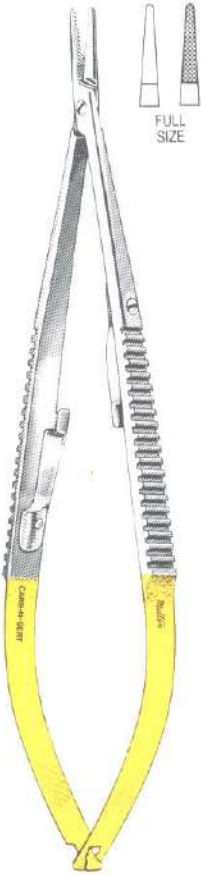

18-1828TC
18-1828A-TC

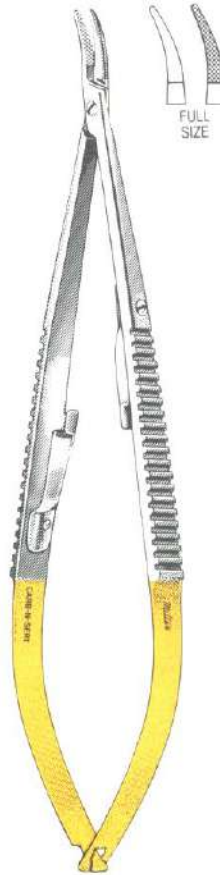

18-1832TC
18-1832A-TC

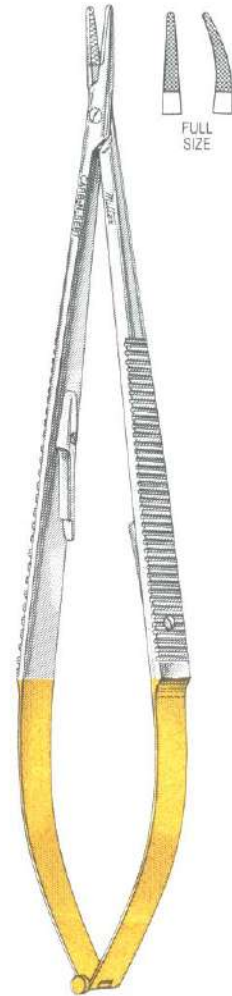

17-1090TC to 17-1092TC

- 18-1828TC** CASTROVIEJO Needle Holder 5½" (14 cm), straight, with lock, smooth jaws
- 18-1828A-TC** CASTROVIEJO Needle Holder 5½" (14 cm), straight, with lock, serrated jaws 16000 teeth p. sq. inch
- 18-1832TC** CASTROVIEJO Needle Holder 5½" (14 cm), curved, with lock, smooth jaws
- 18-1832A-TC** CASTROVIEJO Needle Holder 5½" (14 cm), curved, with lock, serrated jaws 16000 teeth p. sq. inch
- 17-1090TC** JACOBSON Microvascular Needle Holder 7" (17.8 cm), straight, with lock, serrated jaws 16000 teeth p. sq. inch
- 17-1091TC** JACOBSON Microvascular Needle Holder 7" (17.8 cm), curved, with lock, serrated jaws 16000 teeth p. sq. inch
- 17-1092TC** JACOBSON Microvascular Needle Holder 8½" (21.6 cm), straight, with lock, serrated jaws 16000 teeth p. sq. inch

Carb-N-Sert Needle Holders



CARB-N-SERT NEEDLE HOLDERS
with tungsten carbide inserts
insure firm holding of needles and sutures

With QUICK-RELEASE RATCHET
(suitable for Left Handers)

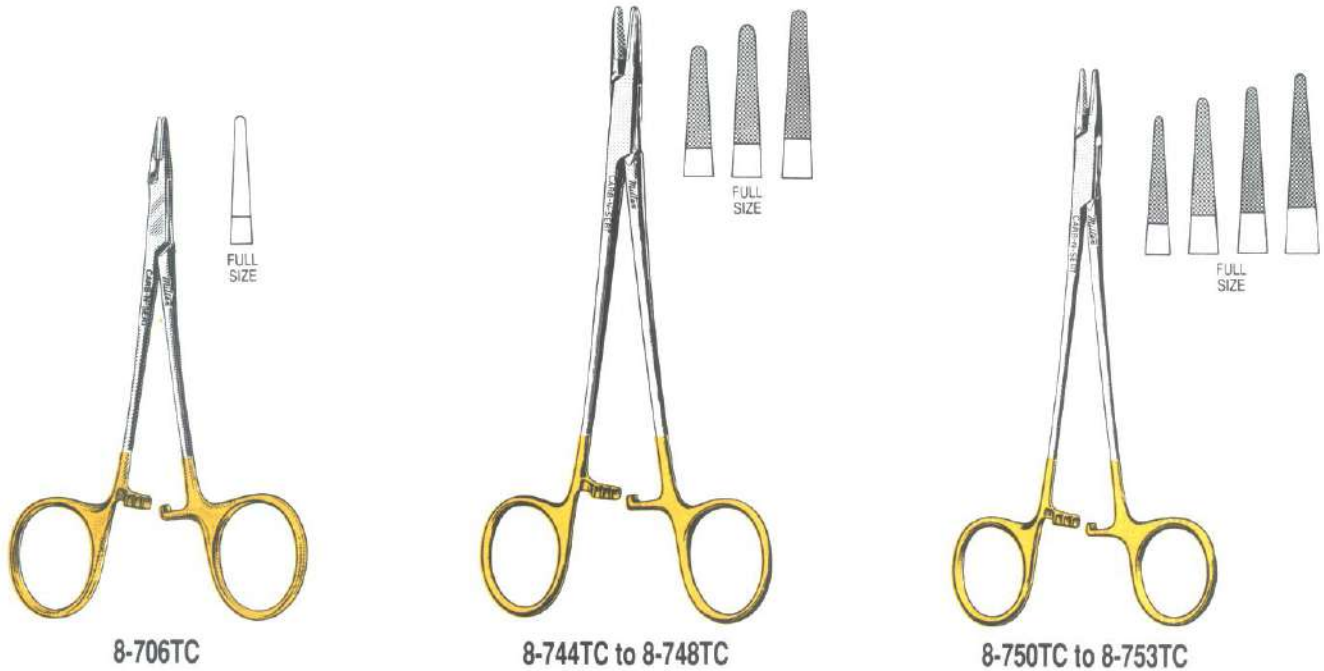

- 8-706TC** WEBSTER Quick-Release Needle Holder 5" (12.7 cm), smooth jaws
- 8-744TC** MAYO-HEGAR Quick-Release Needle Holder 6" (15.2 cm), serrated jaws 2600 teeth p. sq. inch
- 8-746TC** MAYO-HEGAR Quick-Release Needle Holder 7" (17.8 cm), serrated jaws 2600 teeth p. sq. inch
- 8-748TC** MAYO-HEGAR Quick-Release Needle Holder 8" (20.3 cm), serrated jaws 2600 teeth p. sq. inch
- 8-750TC** CRILE-WOOD Quick-Release Needle Holder 6" (15.2 cm), serrated jaws 4000 teeth p. sq. inch
- 8-751TC** CRILE-WOOD Quick-Release Needle Holder 7" (17.8 cm), serrated jaws 4000 teeth p. sq. inch
- 8-752TC** CRILE-WOOD Quick-Release Needle Holder 8" (20.3 cm), serrated jaws 4000 teeth p. sq. inch
- 8-753TC** CRILE-WOOD Quick-Release Needle Holder 9" (22.9 cm), serrated jaws 4000 teeth p. sq. inch

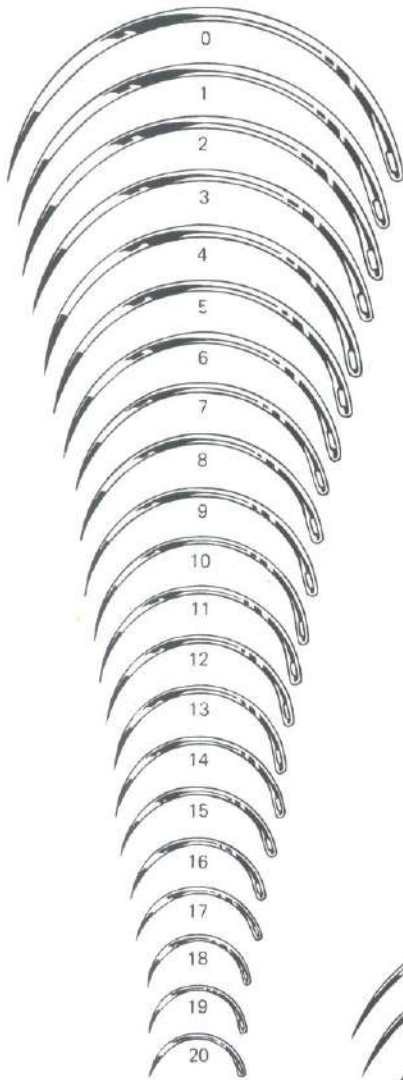

MS-192
REGULAR SURGEON'S
1/2 Circle
Cutting Edge

MS-192S
Same as above
with Spring Eye

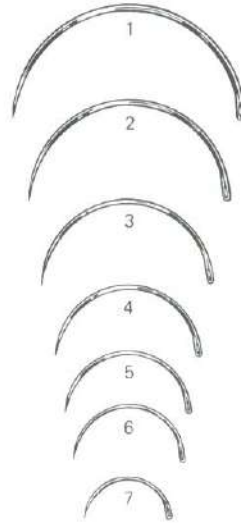

MS-150
ROUND BODIED
1/2 Circle
Taper Point



MS-141
REGULAR SURGEON'S
Half Curved
Cutting Edge

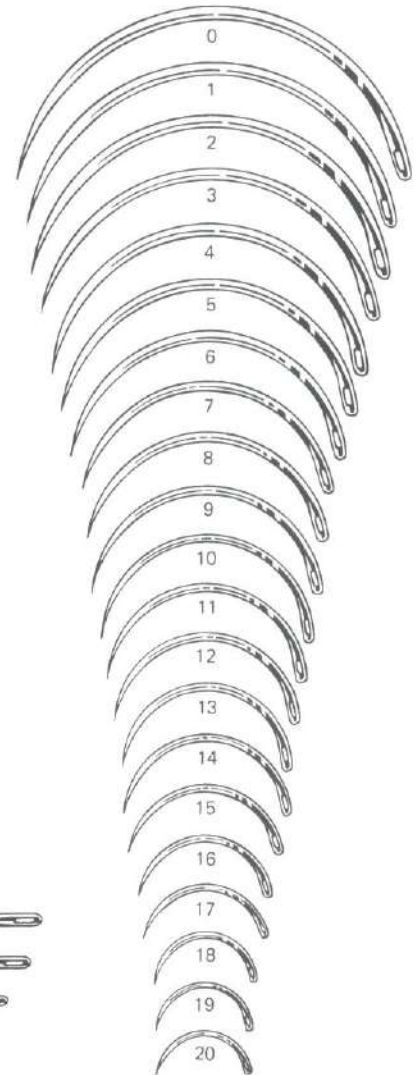

MS-192A
REGULAR SURGEON'S
1/2 Circle
Taper Point

All needles shown actual size

Needles are packed in packages of 12.

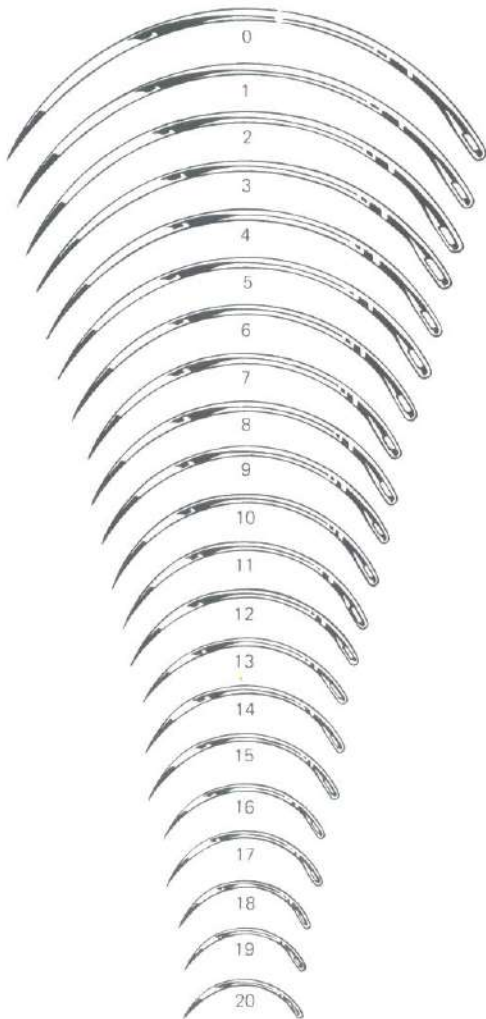

MS-140
REGULAR SURGEON'S
3/8 Circle
Cutting Edge

MS-140S
Same as above
with Spring Eye

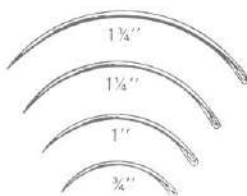

MS-153
MAYO INTESTINAL
3/8 Circle
Taper Point

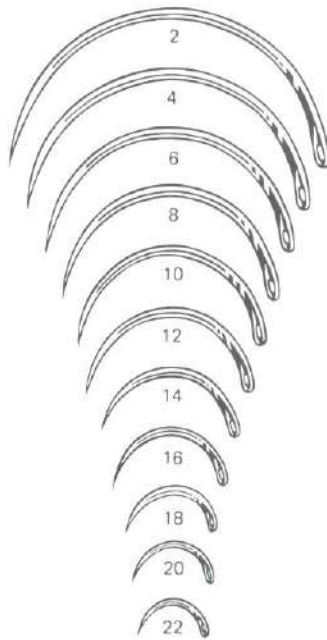

MS-126
FERGUSON
1/2 Circle
Taper Point

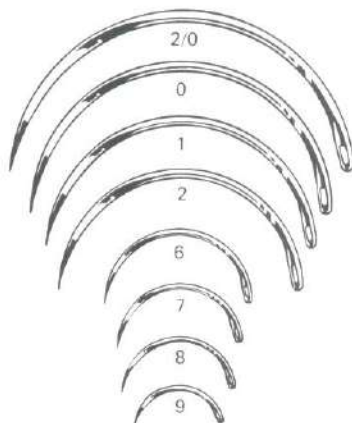

MS-450
FISTULA
1/2 Circle
Cutting Edge

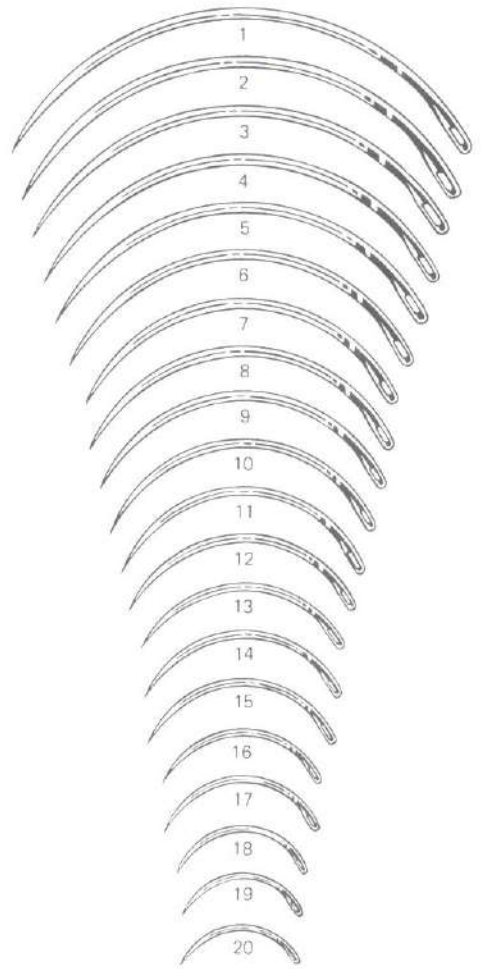

MS-140A
REGULAR SURGEON'S
3/8 Circle
Taper Point

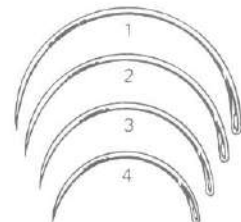

MS-179
MURPHY'S INTESTINAL
1/2 Circle
Taper Point

All needles shown actual size.

Needles are packed in packages of 12.



Surgical Needles



MS-431
KEITH ABDOMINAL
Straight
Triangular Point

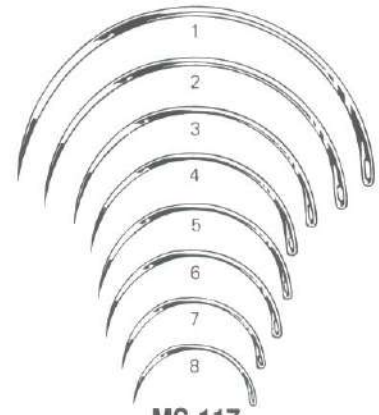

MS-117
MARTIN'S UTERINE
1/2 Circle
Cutting Edge

Eye Needles



MS-172
EYE NEEDLE
3/8 Circle
Cutting Edge

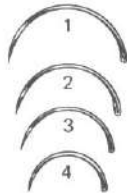

MS-175
EYE NEEDLE
1/2 Circle
Cutting Edge



MS-177
JAMESON STRABISMUS
Cutting Edge

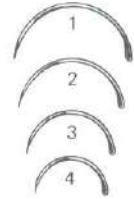

MS-176
EYE NEEDLE
1/2 Circle
Taper Point

Dental Needles



MS-155
LANE CLEFT PALATE
3/8 Circle
Cutting Edge

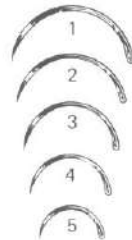

MS-156
LANE CLEFT PALATE
1/2 Circle
Cutting Edge

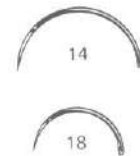

MSRC-14
MSRC-18
DENTAL
REVERSE CUTTING EDGE
1/2 Circle

All needles shown actual size

Needles are packed in packages of 12.

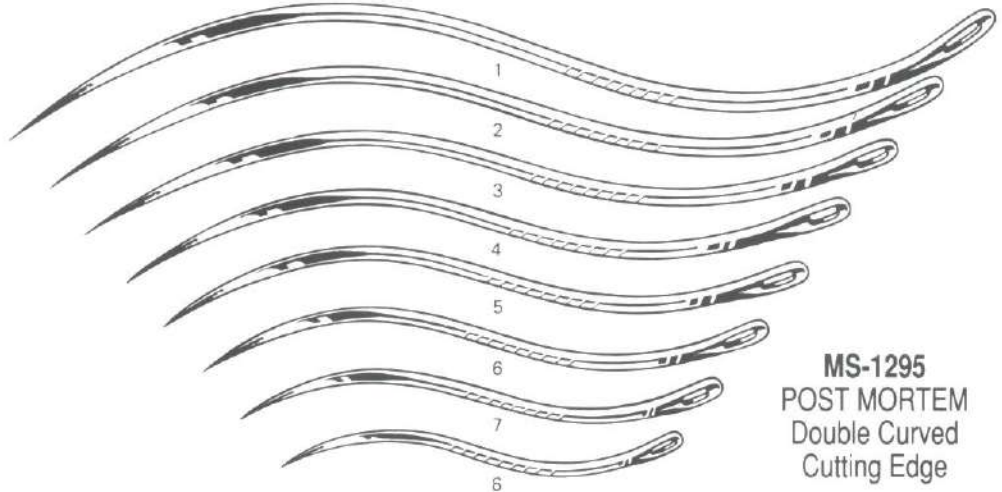
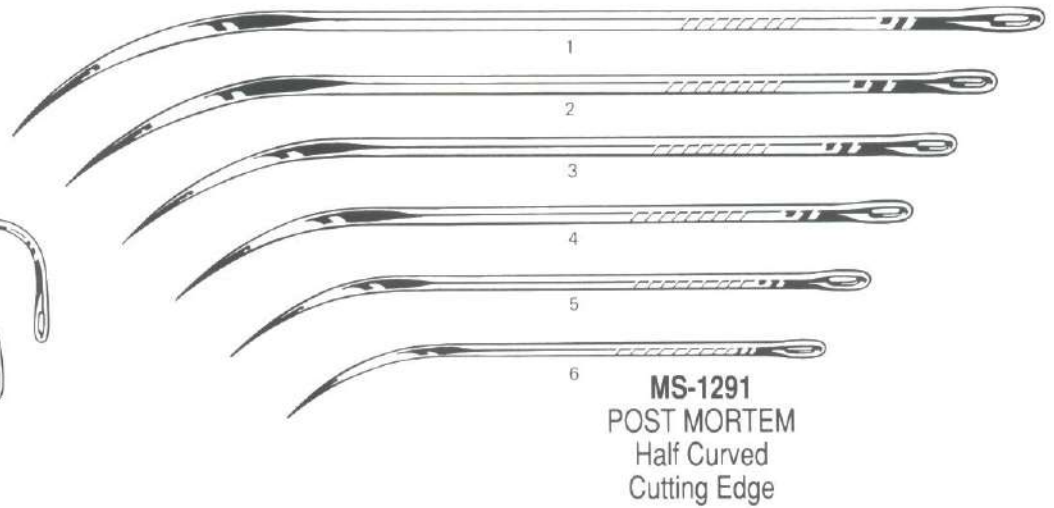
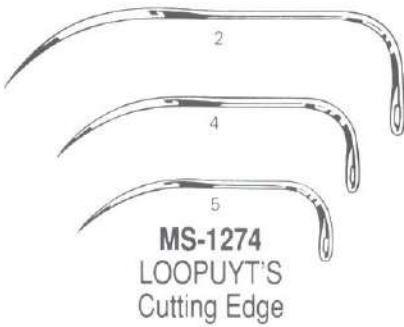
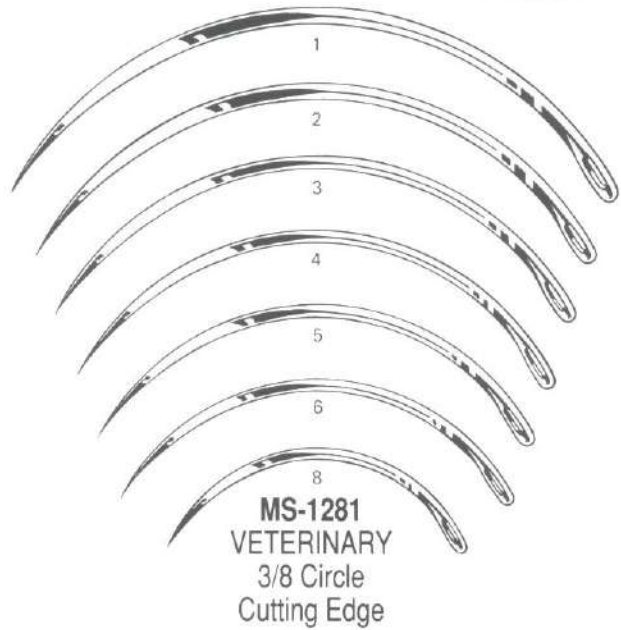

All needles have Regular eyes,
unless otherwise noted.

Needles are packed
in packages of 12.

All needles shown
actual size.

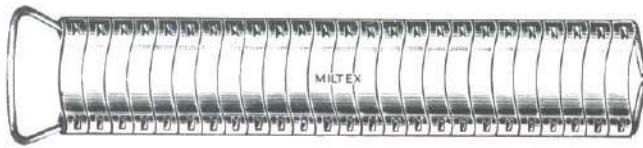

9-1 to 9-10

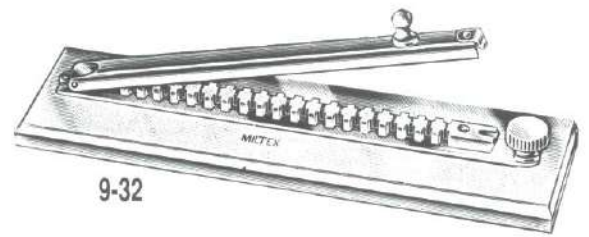

9-32

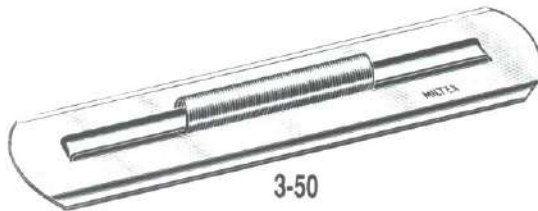

3-50

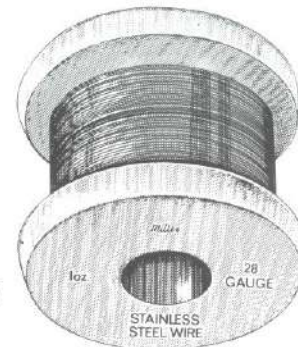

9-40 to 9-44

MICHEL WOUND CLIPS (100 to an envelope, 1000 to a box), stainless

9-1	size 7.5 mm	9-6	size 16 mm
9-2	size 11 mm	9-8	size 18 mm
9-4	size 14 mm	9-10	size 22 mm

9-32 McKENZIE Brain Clip Holding Rack, for 20 clips

3-50 Sterilizing Spiral Rack for Surgical Needles

BABCOCK SUTURE WIRE, Stainless Steel Type AISI 316-L

B&S Gauge	Diameter	1 oz. (28 g) Spools	4 oz. (113 g) Spools
18	.040" (1 mm)	9-40-18	9-44-18
20	.032" (.8 mm)	9-40-20	9-44-20
22	.025" (.6 mm)	9-40-22	9-44-22
24	.020" (.5 mm)	9-40-24	9-44-24
25	.018" (.45 mm)	9-40-25	9-44-25
26	.016" (.4 mm)	9-40-26	9-44-26
28	.012" (.3 mm)	9-40-28	9-44-28
30	.010" (.25 mm)	9-40-30	9-44-30
32	.008" (.2 mm)	9-40-32	9-44-32
34	.006" (.15 mm)	9-40-34	9-44-34
36	.005" (.13 mm)	9-40-36	—



9-50



9-52



9-54



9-60

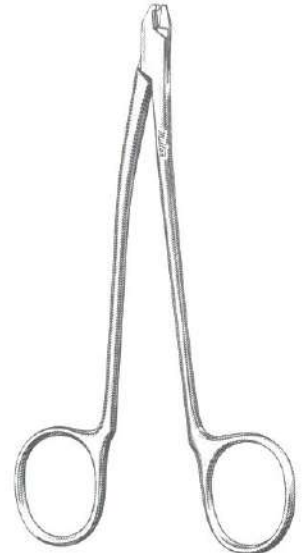

9-62

- 9-50 MICHEL Clip Applying Forceps 4¾" (12.1 cm)
- 9-52 HEGENBARTH Clip Applying Forceps 4¾" (12.1 cm), cross action
- 9-54 WACHENFELD Clip Applying-Removing Forceps 4¾" (12.1 cm), cross action
- 9-60 MICHEL Clip Applying-Removing Forceps 5" (12.7 cm), double ended
- 9-62 MILTEX Skin Staple Removing Forceps 5½" (14 cm)



9-74

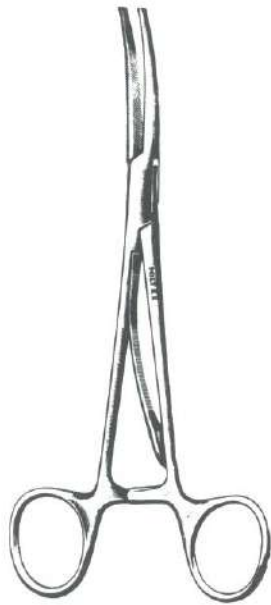

9-80

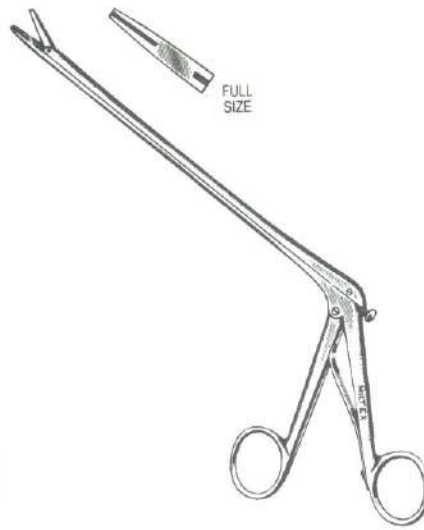

9-90

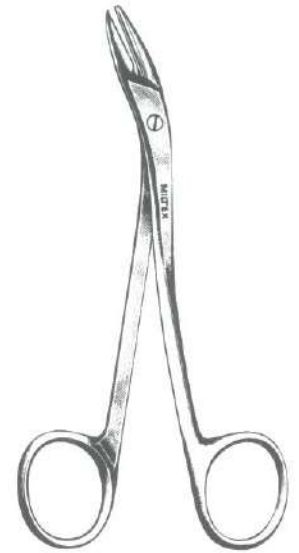

9-94

- 9-74 SMITHWICK Clip Applying Forceps 9" (22.9 cm), curved jaws, straight handles
- 9-80 MCKENZIE Clip Applying Forceps 6" (15.2 cm), curved jaws, straight handles
- 9-90 SCOVILLE Clip Applying Forceps 6" (15.2 cm) shaft
- 9-94 RICHTER HEATH Clip Removing Forceps 5½" (14 cm)



17-303



18-1107

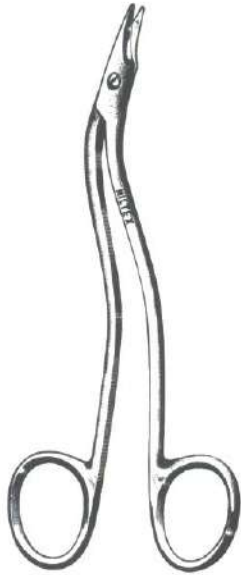

9-96

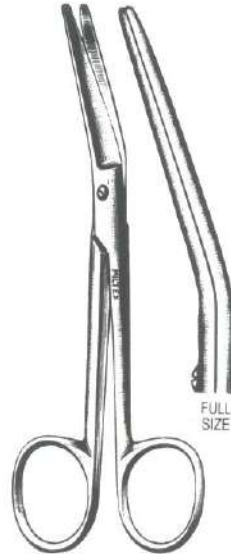

9-98

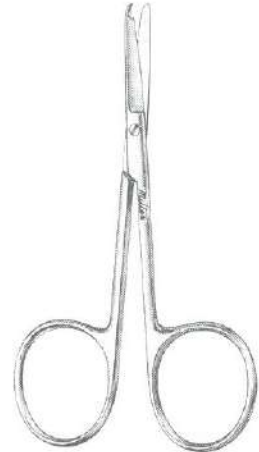

9-100

- 17-303 Suture Forceps (style 3), narrow, fine 4 $\frac{3}{4}$ " (12.1 cm)
- 18-1107 Swiss Cilia and Suture Forceps 3 $\frac{3}{4}$ " (9.5 cm), precision fitted diagonal jaws 3 mm wide
- 9-96 HEATH Suture Scissors 6 $\frac{1}{8}$ " (15.4 cm), serrated blade
- 9-98 NEW'S Suture Scissors 5 $\frac{1}{2}$ " (14 cm), angled on flat
- 9-100 SPENCER Stitch Scissors 3 $\frac{1}{2}$ " (8.9 cm), delicate
- 9-101 SHORTBENT Stitch Scissors 3 $\frac{1}{2}$ " (8.9 cm), curved, delicate
- 9-102 LITTAUER JR. Stitch Scissors 4 $\frac{1}{2}$ " (11.4 cm), light pattern



9-101

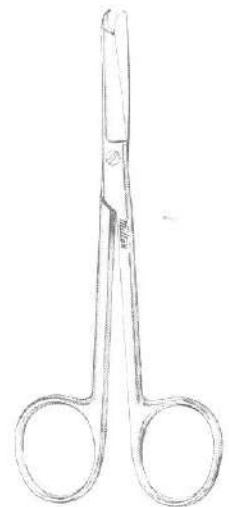

9-102



9-103

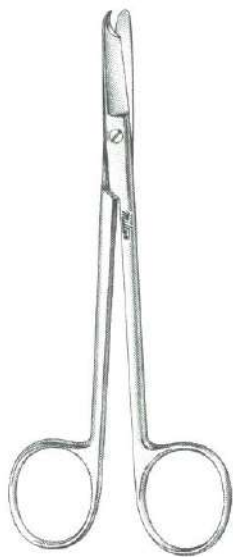

9-104



9-106

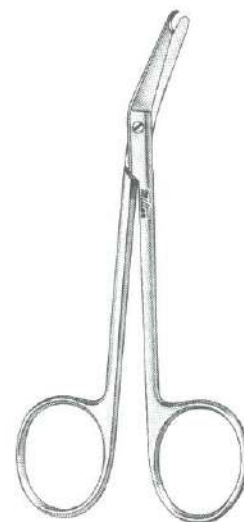

9-108

- 9-103 NORTHBENT Stitch Scissors 4¾" (12.1cm), curved, light pattern
- 9-104 LITTAUER Stitch Scissors 5½" (14 cm), standard pattern
- 9-106 LONG Oral Surgery Stitch Scissors 6" (15.2 cm)
- 9-108 MILTEX Stitch Scissors 4½" (11.4 cm), angled, delicate
- 9-110 O'BRIEN Stitch Scissors 3¾" (9.5 cm), angled, sharp points

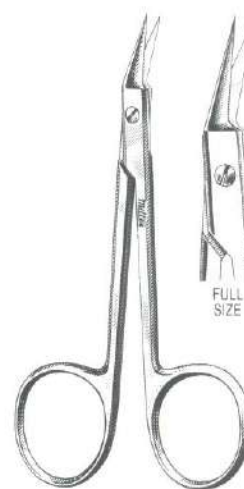

9-110



18-1486

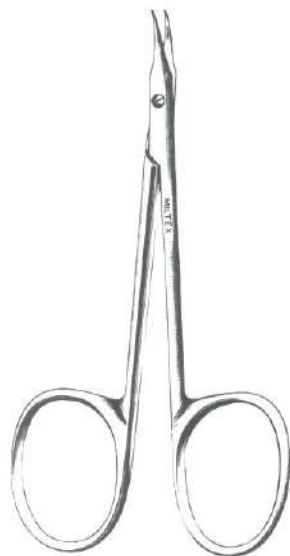

18-1652



18-1653*

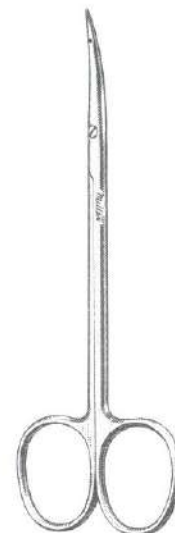

21-536

- 18-1486 WESTCOTT Stitch Scissors 4½" (11.4 cm), curved, sharp points
- 18-1652 Eye Suture (GRADLE) Scissors 3¾" (9.5 cm), slightly curved, sharp points
- 18-1653* Eye Suture Scissors 4" (10.2 cm), slightly curved, sharp points, ribbon type
- 21-536 LITTLER Suture Carrying Scissors 4⅝" (11.8 cm), with suture hole in blades, curved

For a complete selection of Carb-N-Sert Eye Scissors with Tungsten Carbide blades and Super Cut Scissors see pages 58, 62 and 63.

*Ribbon type scissors have extra large finger rings; shanks and rings have satin finish; blades are highly polished.



9-120
9D-121



9-122
9D-123



9-124
9-124TC

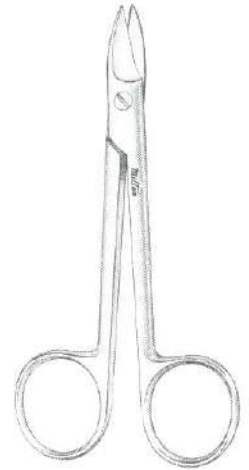

9D-132
9D-133

WIRE CUTTING SCISSORS 4³/₄" (12.1 cm)

- 9-120 Straight, one serrated blade
- 9D-121 Straight
- 9-122 Curved, one serrated blade
- 9D-123 Curved
- 9-124 Angled to side, one serrated blade
- 9-124TC Angled to side, one serrated blade, Carb-N-Sert inserts

WIRE CUTTING SCISSORS 4¹/₄" (10.8 cm)

- 9D-132 Straight, one serrated blade
- 9D-133 Straight
- 9D-134 Curved, one serrated blade
- 9D-135 Curved

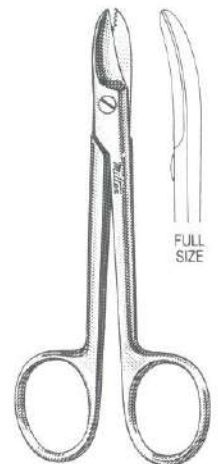

9D-134
9D-135

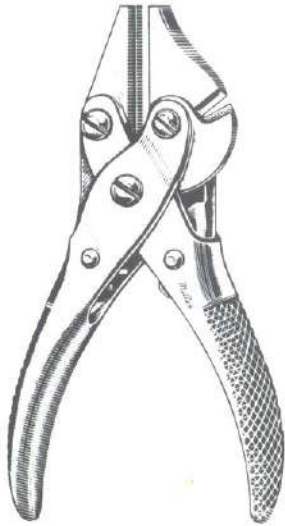

9-128



22-500TC
22-502TC



27-176TC

- 9-128 Double Action Parallel Pliers and Wire Cutter
4½" (11.4 cm), nickel plated
- 22-500TC Wire Twister 6" (15.2 cm), CARB-N-SERT jaws
- 22-502TC Wire Twister 8" (20.3 cm), CARB-N-SERT jaws
- 27-176TC MILTEX Pin Puller 5½" (14 cm), CARB-N-SERT cross serrated
top jaw measures 1 cm in length. Grooved cross serrated
opposing jaw (groove measures 1 cm in length).
- 9-140 DESCHAMPS Ligature Carrier 8" (20.3 cm), blunt, left
- 9-142 DESCHAMPS Ligature Carrier 8" (20.3 cm), blunt, right
- 9-146 DESCHAMPS Ligature Carrier 8" (20.3 cm), sharp, left
- 9-148 DESCHAMPS Ligature Carrier 8" (20.3 cm), sharp, right

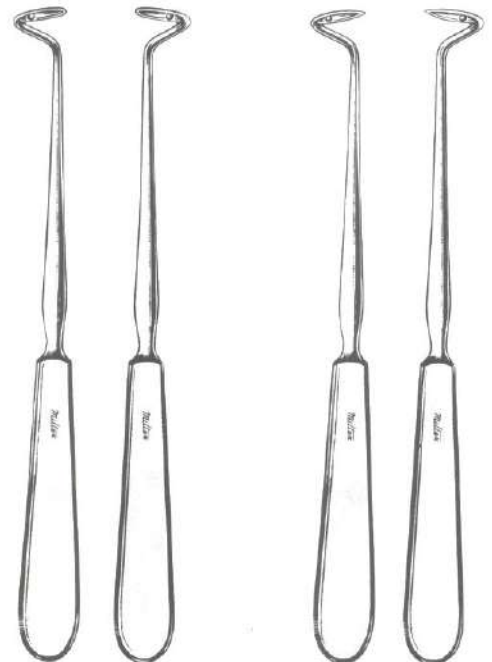

9-140
9-142

9-146
9-148

For additional Orthopedic Pin & Wire instruments see pages 443,444



9-154
9-156



12-90
12-92



21-900



21-901



21-902



26-590

- 9-154 DUPUYS-WEISS Ligature Carrier 8½" (21.6 cm), right
- 9-156 DUPUYS-WEISS Ligature Carrier 8½" (21.6 cm), left
- 12-90 LAHEY Ligature Carrier 7½" (19.1 cm), curved left
- 12-92 LAHEY Ligature Carrier 7½" (19.1 cm), curved right
- 21-900 OBWEGESER Mandibular Awl for wire suturing 5½" (14 cm), slightly curved
- 21-901 OBWEGESER Maxillary Awl for wire suturing 7" (17.8 cm), strong curve
- 21-902 OBWEGESER Zygomatic Arch Awl for wire suturing 9" (22.9 cm), slightly curved
- 26-590 RANEY Scalp Clip Applying Forceps 6¼" (15.9 cm)
- 26-591 RANEY Reusable Scalp Clips, black finish (pkg. of 12)
- 26-660 ADSON Aneurysm Needle 9" (22.9 cm)
- 27-110 Bone Wire Guide 8¾" (22.2 cm), U.S. Pattern



26-591



26-660



27-110



10-2 to 10-14



10-22 to 10-34



10-38



10-69 to 10-76



10-79 to 10-84



28-100

PROBES, DOUBLE ENDED, Malleable

Nickel-Silver

10-2-NS	4½" (11.4 cm)
10-4-NS	5" (12.7 cm)
10-6-NS	5½" (14 cm)
10-8-NS	6" (15.2 cm)
10-10-NS	7" (17.8 cm)
10-12-NS	8" (20.3 cm)
10-14-NS	10" (25.4 cm)

Sterling

10-2-ST
10-4-ST
10-6-ST
10-8-ST
10-10-ST
10-12-ST
10-14-ST

10-38

Probe with Myrtle Leaf 5" (12.7 cm)

PROBES WITH EYE, Malleable

Stainless

10-22-SS	4½" (11.4 cm)
10-24-SS	5" (12.7 cm)
10-26-SS	5½" (14 cm)
10-28-SS	6" (15.2 cm)
10-30-SS	7" (17.8 cm)
10-32-SS	8" (20.3 cm)
10-34-SS	10" (25.4 cm)

Sterling

10-22-ST
10-24-ST
10-26-ST
10-28-ST
10-30-ST
10-32-ST
10-34-ST

GROOVED DIRECTORS

With Tongue Tie

10-69	4½" (11.4 cm)
10-70	5" (12.7 cm)
10-72	5½" (14 cm)
10-74	6" (15.2 cm)
10-76	8" (20.3 cm)

With Probe Tip and Tongue Tie

10-79
10-80
10-82
10-84
—

28-100

LARRY Probe and Grooved Director 7" (17.8 cm)



18-710 to 18-720

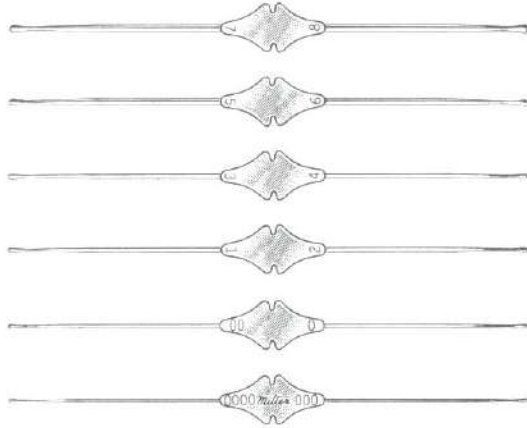

18-722 to 18-732

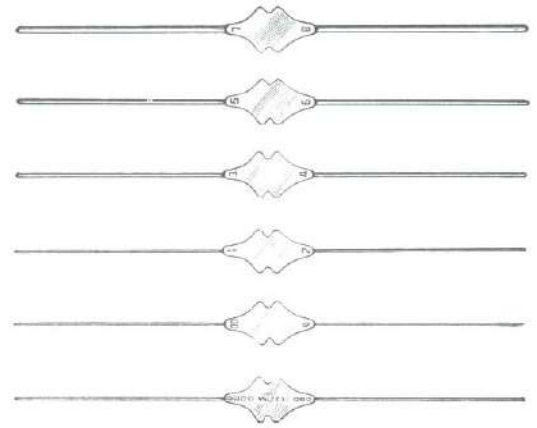

18-740 to 18-750

FRENCH PATTERN LACRIMAL PROBES 5" (12.7 cm)

Bayonet shape

18-710	size 00	18-716	size 2
18-712	size 0	18-718	size 3
18-714	size 1	18-720	size 4

WILLIAMS LACRIMAL PROBES 5" (12.7 cm), sterling

18-722	size 0000-000	18-728	size 3-4
18-724	size 00-0	18-730	size 5-6
18-726	size 1-2	18-732	size 7-8

BOWMAN LACRIMAL PROBES 5" (12.7 cm), sterling

18-740	size 0000-000	18-746	size 3-4
18-742	size 00-0	18-748	size 5-6
18-744	size 1-2	18-750	size 7-8

19-210 BUCK (SPENCER) Ear Probe
5½" (14 cm), sterling shaft

20-100 THEOBALD (FISH) Sinus Probe
6" (15.2 cm), sterling

20-102 SKILLERN Sinus Probe 6½" (16.5 cm),
graduated, sterling

28-104 BARR Fistula Probe, with 8" (20.3 cm)
sterling shaft, eye at tip, 11½" (29.2 cm) overall



19-210

20-100

20-102

28-104

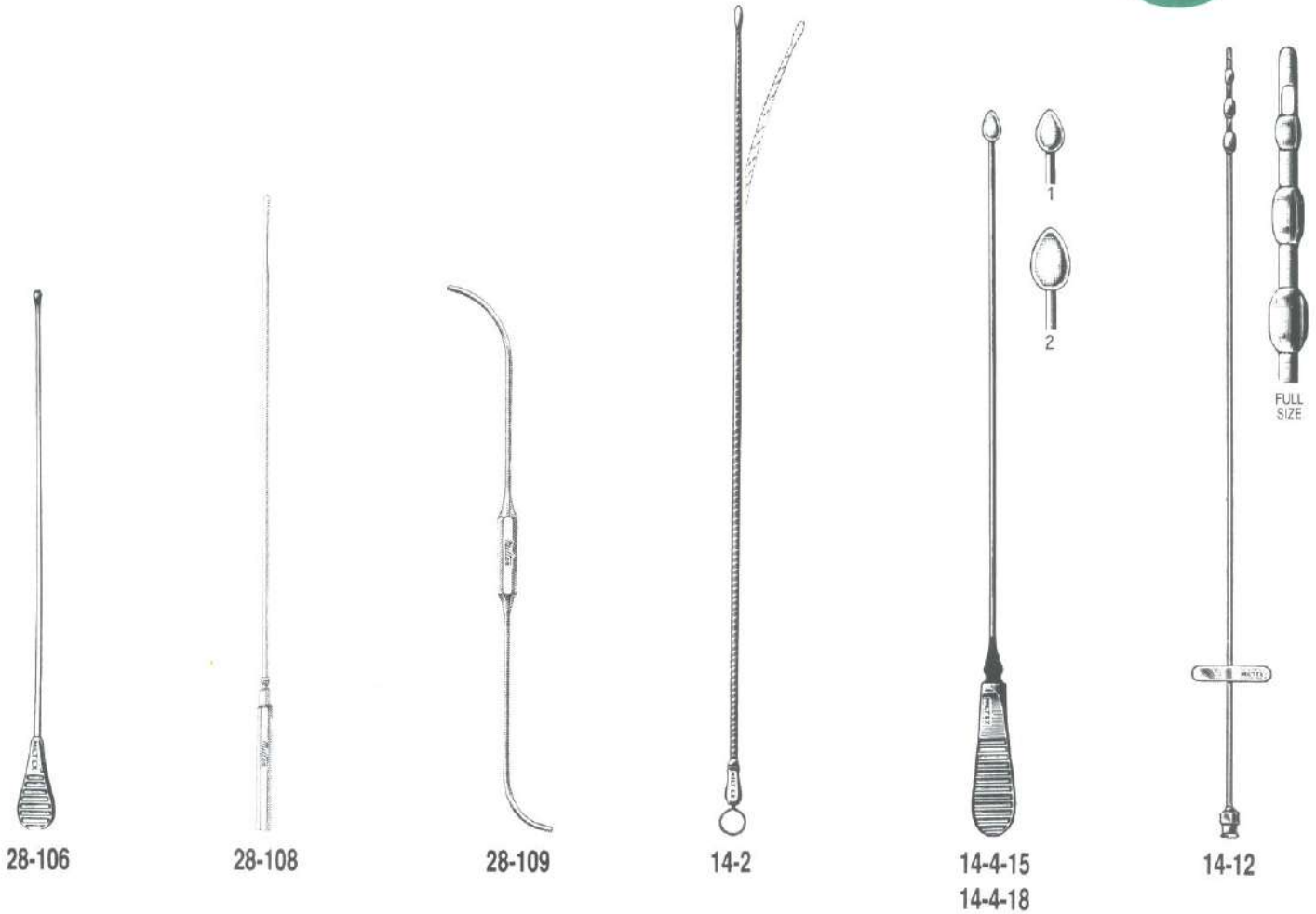

- 28-106** BUIE Fistula Probe, with 5½" (14 cm) sterling shaft, 6¾" (17.1 cm) overall
- 28-108** PRATT Rectal Probe, with 7¾" (19.7 cm) sterling shaft, 11" (27.9 cm) overall
- 28-109** BARR Double Ended Probe 7" (17.8 cm), rigid
- 14-2** OCHSNER (FENGER) Gall Duct Probe, cannulated flexible spiral 14" (35.6 cm) with stylet
- 14-4-15** MAYO Common Duct Probe 10" (25.4 cm), malleable shaft, 15 French (5 mm)
- 14-4-18** MAYO Common Duct Probe 10" (25.4 cm), malleable shaft, 18 French (5.9 mm)
- 14-12** MIXTER Irrigating Dilaprobe 12" (30.5 cm), malleable, with Luer Lock, silver plated

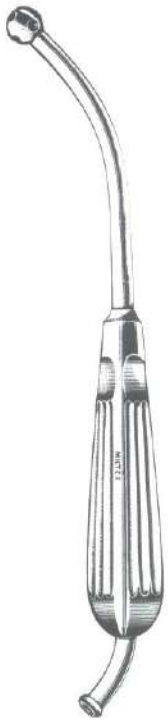

2-100



2-109



2-110
2-110SS



2-104
2-104SS



FULL
SIZE

2-106
2-106SS

- 2-100 PYNCHON Suction Tube 11" (27.9 cm), tip with large openings, with removable tubing connection, chrome
- 2-109 YANKAUER Pediatric Suction Tube 8½" (21.6 cm), with removable tip, delicate pattern
- 2-110 ANDREWS-PYNCHON Suction Tube 10" (25.4 cm), delicate pattern, chrome
- 2-110SS ANDREWS-PYNCHON Suction Tube 10" (25.4 cm), delicate pattern
- 2-104 YANKAUER Suction Tube 11¾" (29.8 cm), with removable tip and tubing connection, chrome
- 2-104SS YANKAUER Suction Tube 11¾" (29.8 cm), with removable tip and tubing connection
- 2-106 Tip for Yankauer Suction Tube, chrome
- 2-106SS Tip for Yankauer Suction Tube
- 10-220 ANTHONY Suction Tube 10" (25.4 cm), lumen 2 mm, chrome



10-220

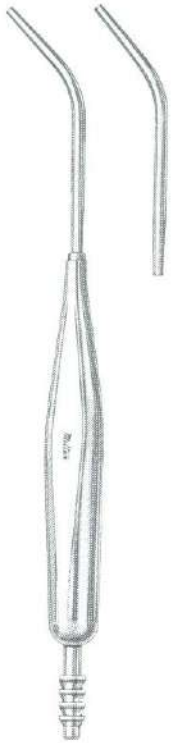

20-466



10-310



10-312



19-562 to 19-565



19-570 to 19-577

20-466 COUPLAND Suction Tube 10" (25.4 cm), with 2 interchangeable tips 1.5 and 2 mm, chrome

10-310 POOLE Suction Tube 23 Fr. (7.6 mm), curved

10-312 POOLE Suction Tube 30 Fr. (9.9 mm), straight

HOUSE SUCTION-IRRIGATION TUBES, 9 cm working length

19-562 1.8 mm Suction Tube and 1.8 mm Irrigating Tube

19-563 2.5 mm Suction Tube and 2 mm Irrigating Tube

19-564 3 mm Suction Tube and 2 mm Irrigating Tube

19-565 4.5 mm Suction Tube and 2 mm Irrigating Tube

FRAZIER FERGUSON SUCTION TUBES, with finger cut-off, angled

19-570 6 French (2 mm) **19-575** 10 French (3.3 mm)

19-572 7 French (2.3 mm) **19-576** 11 French (3.6 mm)

19-573 8 French (2.6 mm) **19-577** 12 French (4 mm)

19-574 9 French (3 mm)

20-460 FRAZIER FERGUSON Suction Tube 9 French (3 mm), straight, with finger cut-off



20-460



19-580 to 19-584



19-1820



19-589



26-780
26-782

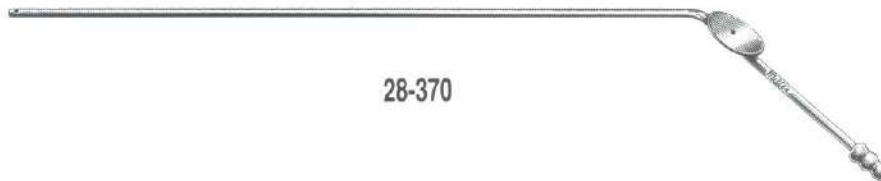

28-370

- 19-580** BARON Suction Tube 3 French (1 mm), with finger cut-off, 7.5 cm tube
- 19-582** BARON Suction Tube 5 French (1.7 mm), with finger cut-off, 7.5 cm tube
- 19-584** BARON Suction Tube 7 French (2.3 mm), with finger cut-off, 7.5 cm tube
- 19-1820** Ear Suction Tube with 2 interchangeable tips 20 ga. and 22 ga.
- 19-589** ANTHONY Suction Tube 6½" (16.5 cm), with 3 mm lumen
- 26-780** ADSON Suction Tube 6" (15.2 cm), with finger valve and obturator, 11 Fr. (3.6 mm)
- 26-782** ADSON Suction Tube 8" (20.3 cm), with finger valve and obturator, 15 Fr. (5 mm)
- 28-370** BUIE Suction Tube 16" (40.6 cm), with finger valve, 15 Fr. (5 mm)

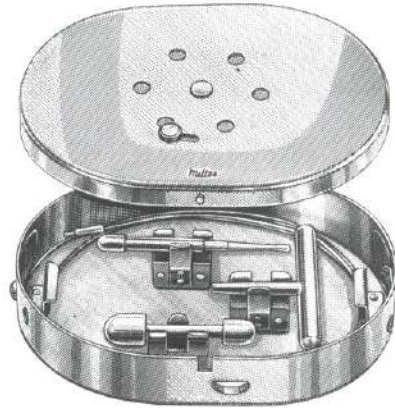

10-290
10-291

- 10-290 NABATOFF Vein Stripper Set, including 2 probe tips, 9 mm, 12 mm and 15 mm olives, and handle with screws on either end of 34" (86.4 cm) cable. Complete in sterilizer case.
- 10-291 NABATOFF Vein Stripper Set, without sterilizer case.



11-2



11-4

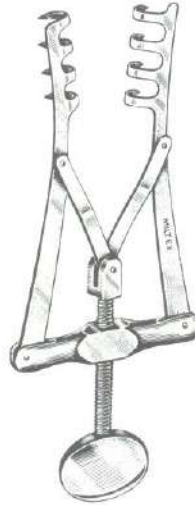

11-6

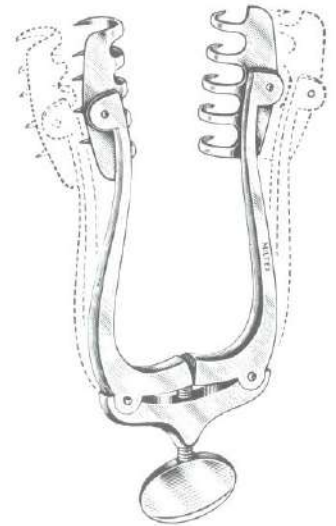

11-8

- 11-2 JANSEN Retractor 4¼" (10.8 cm), spread 3" (7.6 cm), 3 x 3 blunt prongs 10 mm deep, standard model
- 11-4 JANSEN Retractor 4½" (11.4 cm), spread 3" (7.6 cm), 4 x 4 blunt prongs 20 mm deep
- 11-6 ALLPORT Retractor 4" (10.2 cm), spread 2½" (6.4 cm), 4 x 4 sharp prongs
- 11-8 JANSEN-WAGNER Retractor 5" (12.7 cm), 5 x 5 sharp prongs, self-adjusting
- 11-10 DAVIS Retractor 4½" (11.4 cm), 3 x 3 blunt prongs



11-10



11-12
11-13

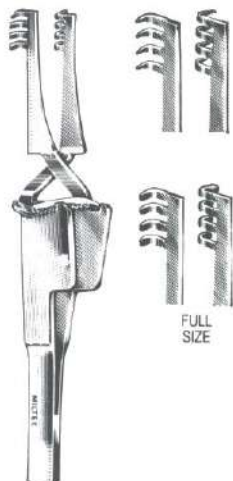

11-14
11-16

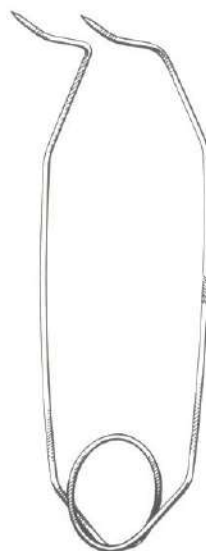

11-17
11-18



11-19

- 11-12 ALM Retractor 2 $\frac{3}{4}$ " (7 cm), spread 2 $\frac{1}{4}$ " (5.7 cm), prongs $\frac{1}{8}$ " (.32 cm) deep
- 11-13 ALM Retractor 3 $\frac{7}{8}$ " (9.8 cm), spread 3" (7.6 cm), prongs $\frac{1}{2}$ " (1.3 cm) deep
- 11-14 MILTEX Cross Action Retractor 4" (10.2 cm), sharp prongs
- 11-16 MILTEX Cross Action Retractor 4" (10.2 cm), blunt prongs
- 11-17 FARR Wire Retractor 5 $\frac{1}{2}$ " (14 cm), prongs $\frac{3}{4}$ " (1.9 cm)
- 11-18 FARR Wire Retractor 5 $\frac{1}{2}$ " (14 cm), prongs 1 $\frac{1}{8}$ " (2.8 cm)
- 11-19 Spring Wire Retractor 3 $\frac{1}{4}$ " (8.3 cm), with blades 10 mm wide x 13 mm deep



18-80



18-84



18-88



18-96

- 18-80 AGRICOLA Retractor 1½" (3.8 cm), 3 x 3 pointed prongs 4 mm deep, non-magnetic
- 18-84 MELLER Retractor 2⅞" (7.3 cm), 3 x 3 prongs 3 mm deep, non-magnetic
- 18-88 GOLDSTEIN Retractor 1⅞" (2.8 cm), 3 x 3 pointed prongs 5 mm deep, non-magnetic
- 18-96 STEVENSON Retractor 3¼" (8.3 cm), 3 x 3 prongs 3 mm deep, non-magnetic



11-20



11-22



11-23

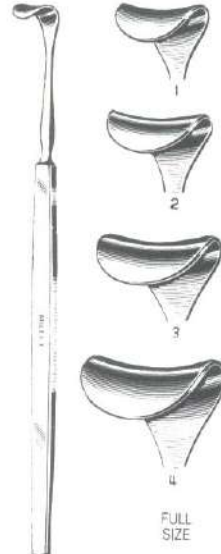

18-110 to 18-116

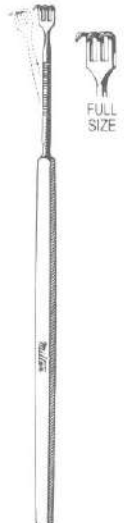

11D-27

- 11-20 LAHEY Retractor 7 $\frac{3}{4}$ " (19.7 cm)
- 11-22 GREEN Retractor 8 $\frac{1}{2}$ " (21.6 cm)
- 11-23 LITTLE Retractor 7 $\frac{3}{4}$ " (19.7 cm)
- 18-110 DESMARRES Retractor 5 $\frac{1}{2}$ " (14 cm), size 1, 11 mm
- 18-112 DESMARRES Retractor 5 $\frac{1}{2}$ " (14 cm), size 2, 13 mm
- 18-114 DESMARRES Retractor 5 $\frac{1}{2}$ " (14 cm), size 3, 15 mm
- 18-116 DESMARRES Retractor 5 $\frac{1}{2}$ " (14 cm), size 4, 17 mm
- 11D-27 Flexible Neck Rake Retractor 5" (12.7 cm), 3 sharp prongs
- 11-30 Flexible Neck Rake Retractor 6" (15.2 cm), 1 sharp prong
- 11-32 Flexible Neck Rake Retractor 6" (15.2 cm), 2 sharp prongs
- 11-34 Flexible Neck Rake Retractor 6" (15.2 cm), 3 sharp prongs
- 11-36 Flexible Neck Rake Retractor 6" (15.2 cm), 1 blunt prong
- 11-38 Flexible Neck Rake Retractor 6" (15.2 cm), 2 blunt prongs
- 11-40 Flexible Neck Rake Retractor 6" (15.2 cm), 3 blunt prongs

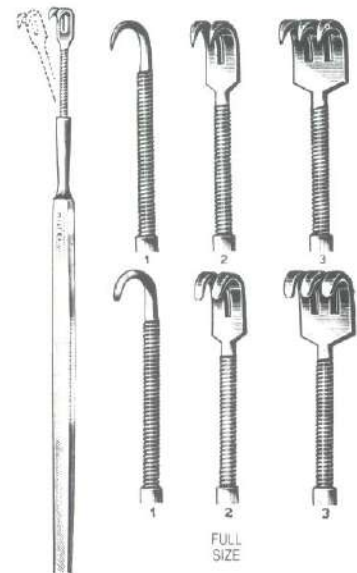

11-30 to 11-40

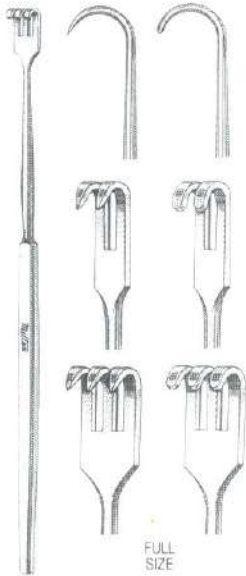

11-50 to 11-60



18-100
18-102



18-439

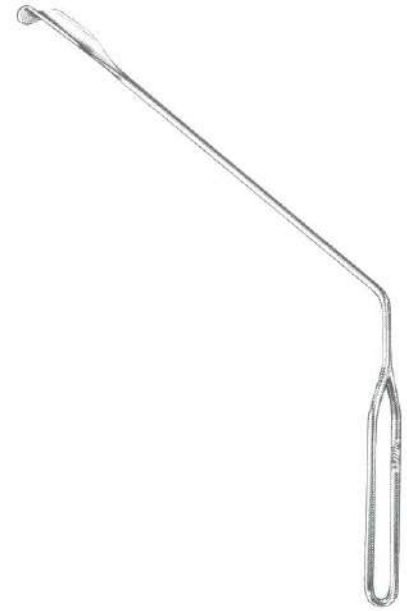

20-835

- 11-50 Rigid Neck Rake Retractor 6" (15.2 cm), 1 sharp prong
- 11-52 Rigid Neck Rake Retractor 6" (15.2 cm), 2 sharp prongs
- 11-54 Rigid Neck Rake Retractor 6" (15.2 cm), 3 sharp prongs
- 11-56 Rigid Neck Rake Retractor 6" (15.2 cm), 1 blunt prong
- 11-58 Rigid Neck Rake Retractor 6" (15.2 cm), 2 blunt prongs
- 11-60 Rigid Neck Rake Retractor 6" (15.2 cm), 3 blunt prongs

- 18-100 KNAPP (ROLLET) Retractor 5¼" (13.3 cm), with 4 sharp prongs
- 18-102 KNAPP Retractor 5¼" (13.3 cm), with 4 blunt prongs

- 18-439 McGANNON Retractor 5" (12.7 cm), fenestrated blade 2.5 mm wide

- 20-835 LOTHROP Retractor 8" (20.3 cm) shaft, grooved blade 40 x 18 mm with 5 mm lip

- 20-836 LOVE Retractor, 18 mm wide blade
- 20-838 LOVE Retractor, 20 mm wide blade
- 20-840 LOVE Retractor, 22 mm wide blade

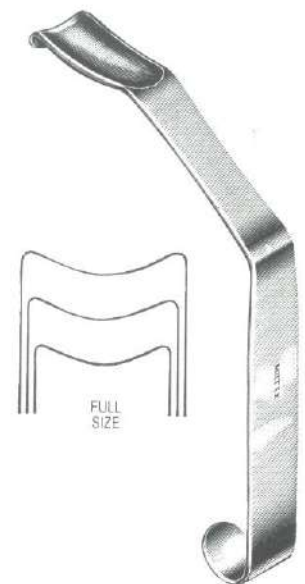

20-836 to 20-840

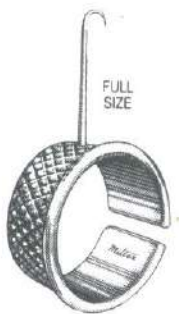

21-107

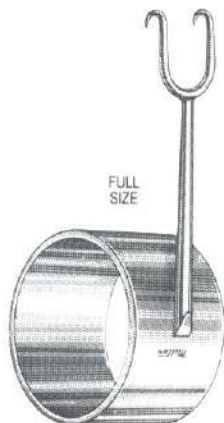

21-108



21-148



21-150



21-163

- 21-107** MILLARD Thimble Retractor, $\frac{5}{8}$ " (1.6 cm) working length, sharp single hook
- 21-108** COTTLE Thumb Retractor, $1\frac{1}{2}$ " (3.8 cm) working length, sharp double hook 8 mm wide
- 21-148** FOMON Retractor $6\frac{1}{2}$ " (16.5 cm), two ball end prongs 11 mm wide
- 21-150** COTTLE Retractor $5\frac{1}{2}$ " (14 cm), four blunt prongs, 2 center prongs recessed
- 21-163** CONVERSE Alar Retractor 4" (10.2 cm), double end, with blunt double hooks 10 mm and 14 mm wide
- 21-165** COTTLE Knife Guide and Retractor 8" (20.3 cm), double end, ball tip prongs 10 mm wide, and 5 mm wide slotted hook



21-165



21-176

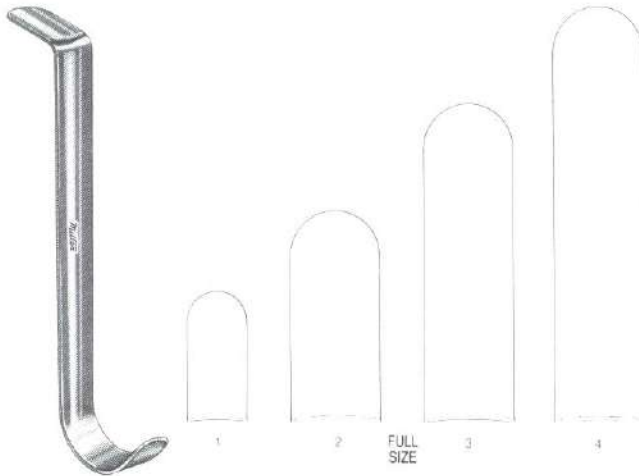

21-182 to 21-185

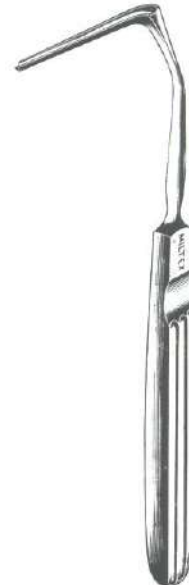

21-188



21-190

- 21-176 NEIVERT Knife Guide and Retractor 6½" (16.5 cm), double end, open blade 14 mm wide
- 21-182 CONVERSE Blade Retractor ¾" (9.5 cm), size 1
- 21-183 CONVERSE Blade Retractor ¾" (9.5 cm), size 2
- 21-184 CONVERSE Blade Retractor ¾" (9.5 cm), size 3
- 21-185 CONVERSE Blade Retractor ¾" (9.5 cm), size 4
- 21-188 AUFRICHT Retractor-Speculum 6½" (16.5 cm), solid blade 45 mm long
- 21-190 AUFRICHT Retractor 7" (17.8 cm), fenestrated blade 45 mm long

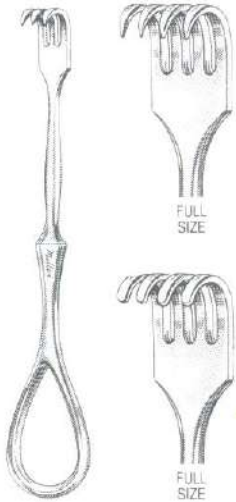

11-42 to 11-49



11-73



11-74
11-76



11-78



11-79

VOLKMAN FINGER RETRACTORS 4½" (11.4 cm)

Sharp		Blunt
11-42	2 prongs	11-46
11-43	3 prongs	11-47
11-44	4 prongs	11-48
11-45	6 prongs	11-49

11-73 RAGNELL Retractor 6" (15.2 cm), double end 3 x 8 mm and 5 x 15 mm blades, delicate

11-74 SENN Retractor 6¾" (16.2 cm), sharp, double end

11-76 SENN Retractor 6¾" (16.2 cm), blunt, double end

11-78 CRILE Retractor 4½" (11.4 cm), double end 3 x 11 mm and 6 x 20 mm blades

11-79 LUER S-Shape Retractor 5½" (14 cm), double end 10 x 5 mm and 14 x 9 mm

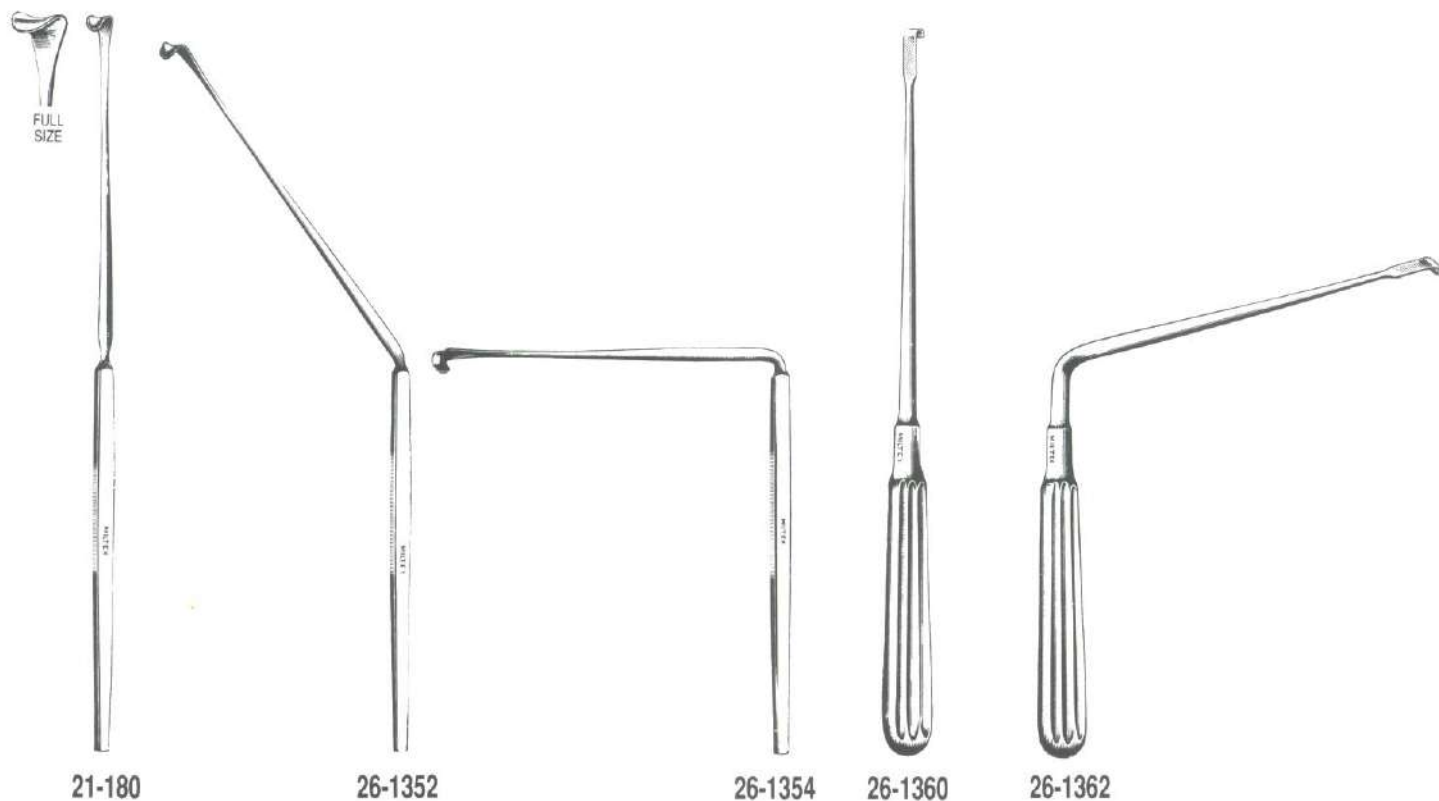

- 21-180** LOVE Nerve Retractor 8½" (21.6 cm), straight, 7 mm blade
- 26-1352** LOVE Nerve Root Retractor 8½" (21.6 cm), angled 45°, 7 mm blade
- 26-1354** LOVE Nerve Root Retractor 8½" (21.6 cm), angled 90°, 7 mm blade
- 26-1360** SCOVILLE Nerve Root Retractor 9" (22.9 cm), straight, 8 mm wide blade
- 26-1362** SCOVILLE Nerve Root Retractor 9" (22.9 cm), angular, 8 mm wide blade
- 11-80** MATHIEU Retractor 6½" (16.5 cm), sharp, double end
- 11-81** MATHIEU Retractor 6½" (16.5 cm), blunt, double end



11-80
11-81

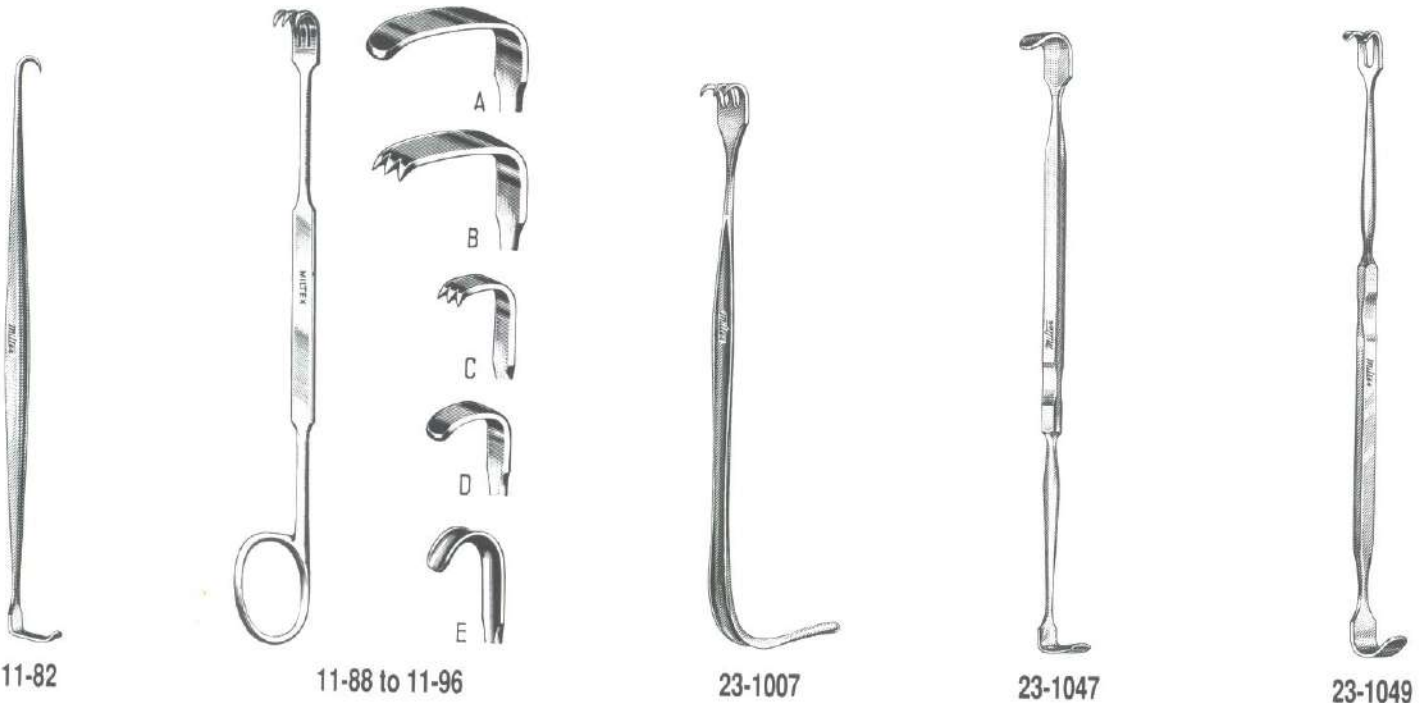

- 11-82 MEYERDING Skin Hook and Retractor 6¼" (15.9 cm), double end
- 11-88 MEYERDING Finger Retractor 7" (17.8 cm), style A. Blade ¼" (.64 cm) x 1½" (1.7 cm)
- 11-90 MEYERDING Finger Retractor 7" (17.8 cm), style B. Blade 3⁄16" (.48 cm) x 5⁄8" (1.6 cm)
- 11-92 MEYERDING Finger Retractor 7" (17.8 cm), style C. Blade 1⁄8" (.32 cm) x ¼" (.64 cm)
- 11-94 MEYERDING Finger Retractor 7" (17.8 cm), style D. Blade 3⁄32" (.24 cm) x 3⁄8" (1 cm)
- 11-96 MEYERDING Finger Retractor 7" (17.8 cm), style E. Blade ¼" (.64 cm) x 7⁄8" (2.2 cm)
- 23-1007 HUPP Retractor 6" (15.2 cm), 3 sharp prongs 12 mm wide, and probe end 35 mm long
- 23-1047 LUKENS Retractor 6¾" (17.1 cm), 10 mm wide curved and 7 mm wide angular blades
- 23-1049 JACKSON Retractor 7" (17.8 cm), double end, 2 blunt prongs 5⁄16" (2.4 cm) wide, and solid blade 3⁄8" (1 cm) wide



25-272
25-274



11-100



11-102



11-110
11-112

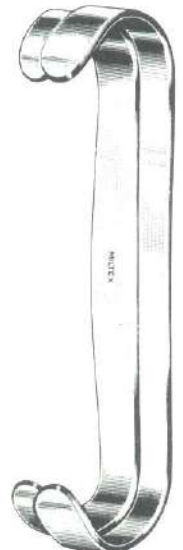

11-114
11-116

- 25-272 SAUERBRUCH Retractor 9" (22.9 cm), blade $\frac{7}{8}$ " (2.2 cm) x $2\frac{1}{4}$ " (5.7 cm)
 25-274 SAUERBRUCH Retractor 9" (22.9 cm), blade $\frac{3}{4}$ " (1.9 cm) x $2\frac{7}{8}$ " (7.3 cm)
- 11-100 CUSHING Decompression Retractor $8\frac{1}{2}$ " (21.6 cm)
 11-102 CUSHING Vein Retractor 9" (22.9 cm), blade 11 x 13 mm
- 11-110 FARABEUFRetractors 6" (15.2 cm), double end, set of two
 11-112 Baby FARABEUFRetractors $4\frac{3}{4}$ " (12.1 cm), double end, set of two
- 11-114 PARKER Retractors 5" (12.7 cm), double end, set of two
 11-116 PARKER Retractors $7\frac{1}{4}$ " (18.4 cm), double end, set of two



22-200



22D-202



22D-209

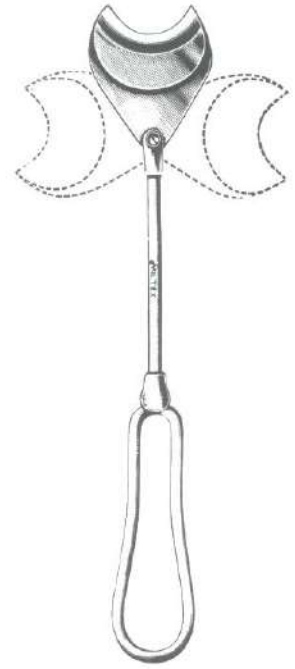

22-210



22-854

- 22-200** MILTEX Lip Retractor 6" (15.2 cm), double end 25 mm and 36 mm wide
- 22D-202** COLUMBIA Lip Retractor 5½" (14 cm), double end 37 mm and 50 mm wide
- 22D-209** UNIVERSITY OF MINNESOTA Cheek Retractor 5½" (14 cm), double end 14 mm and 20 mm wide
- 22-210** Cheek Retractor 7¾" (19.7 cm), with swivel blade 35 mm wide
- 22-854** HURD Tonsil Dissector and Pillar Retractor 9" (22.9 cm), standard pattern, 9 x 25 mm blade

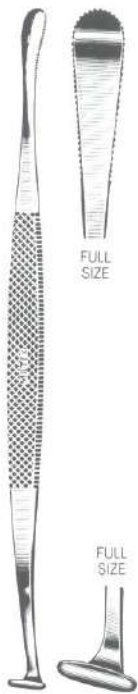

22-856



22-890



11-118



11-120



11-122

- 22-856 MORRISON-HURD Tonsil Dissector and Pillar Retractor 9" (22.9 cm), flat handle, 8 x 25 mm serrated blade
- 22-890 COLVER Tonsil Examining Retractor 8" (20.3 cm), blunt tip
- 11-118 MAYO-COLLINS Retractor 6" (15.2 cm), double end, set of two
- 11-120 GOELET Retractor 7½" (19.1 cm), double end
- 11-122 U.S. ARMY Retractor 8½" (21.6 cm), double end, set of two
- 11-130 Ribbon Retractor ¾" (1.9 cm) x 13" (33 cm), malleable
- 11-132 Ribbon Retractor 1" (2.5 cm) x 13" (33 cm), malleable
- 11-134 Ribbon Retractor 1¼" (3.2 cm) x 13" (33 cm), malleable
- 11-136 Ribbon Retractor 1½" (3.8 cm) x 13" (33 cm), malleable
- 11-140 Ribbon Retractor 2" (5.1 cm) x 13" (33 cm), malleable
- 11-144 Pediatric Ribbon Retractor ⅝" (1.6 cm) x 8" (20.3 cm), malleable
- 11-146 Pediatric Ribbon Retractor 1" (2.5 cm) x 8" (20.3 cm), malleable

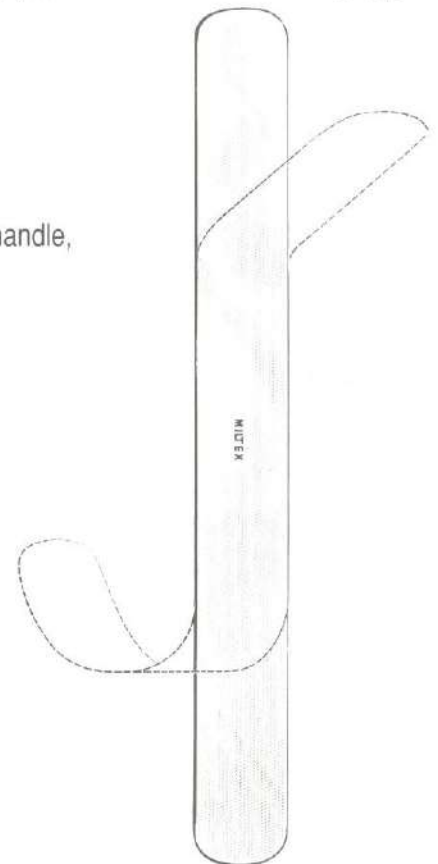

11-130 to 11-146

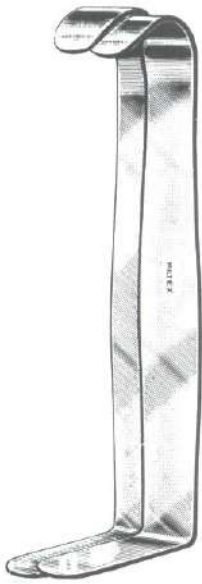

11-150

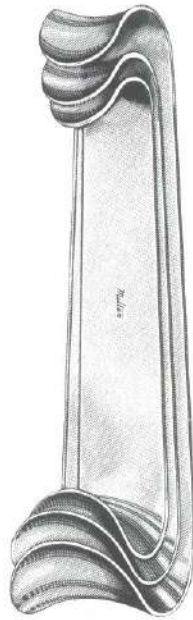

11-152 to 11-155

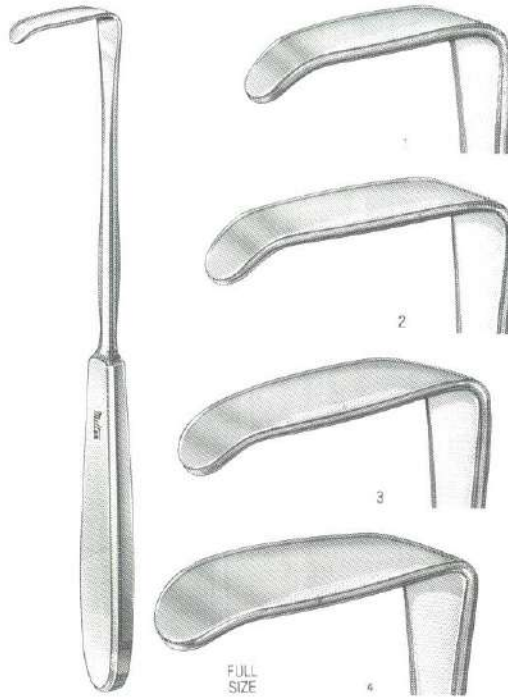

11-160 to 11-166



11-180 to 11-184

- 11-150 PARKER-MOTT Retractors 6" (15.2 cm), double end, set of two
- 11-152 ROUX Retractors 6⁵/₈" (16.8 cm), double end, set of three
- 11-153 ROUX Retractor 5¹/₄" (13.3 cm), small 3/4" (1.9 cm) x 1" (2.5 cm)
- 11-154 ROUX Retractor 5³/₄" (14.6 cm), medium 7/8" (2.2 cm) x 1³/₈" (3.5 cm)
- 11-155 ROUX Retractor 6⁵/₈" (16.8 cm), large 1" (2.5 cm) x 1⁵/₈" (4.1 cm)
- 11-160 LANGENBECK Retractor 8" (20.3 cm), blade 3/8" (1 cm) x 1¹/₄" (3.2 cm)
- 11-162 LANGENBECK Retractor 8" (20.3 cm), blade 3/8" (1 cm) x 1¹/₂" (3.8 cm)
- 11-164 LANGENBECK Retractor 8" (20.3 cm), blade 1/2" (1.3 cm) x 1¹/₂" (3.8 cm)
- 11-166 LANGENBECK Retractor 8" (20.3 cm), blade 5/8" (1.6 cm) x 1¹/₂" (3.8 cm)
- 11-180 HEANEY Retractor 10¹/₂" (26.7 cm), blade 1" (2.5 cm) x 1³/₄" (4.4 cm)
- 11-182 HEANEY Retractor 10¹/₂" (26.7 cm), blade 1¹/₈" (2.8 cm) x 2⁷/₈" (7.3 cm)
- 11-184 HEANEY Retractor 10¹/₂" (26.7 cm), blade 1¹/₈" (2.8 cm) x 3¹/₄" (8.3 cm)

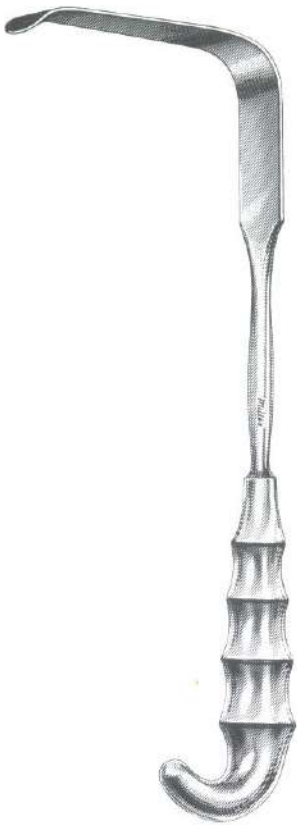

11-185



30-300 to 30-310



30-320 to 30-330

- 11-185 HEANEY-SIMON Retractor 11½" (29.2 cm), blade 1" (2.5 cm) x 4½" (11.4 cm)
- 30-300 JACKSON Retractor 7" (17.8 cm), Blade 1½" (3.8 cm) x 3" (7.6 cm)
- 30-305 JACKSON Retractor 7" (17.8 cm), Blade 1½" (3.8 cm) x 3½" (8.9 cm)
- 30-310 JACKSON Retractor 7" (17.8 cm), Blade 1½" (3.8 cm) x 4" (10.2 cm)
- 30-320 EASTMAN Retractor 7" (17.8 cm), Blade 1½" (3.8 cm) x 3" (7.6 cm)
- 30-325 EASTMAN Retractor 7" (17.8 cm), Blade 1½" (3.8 cm) x 3½" (8.9 cm)
- 30-330 EASTMAN Retractor 7" (17.8 cm), Blade 1½" (3.8 cm) x 4" (10.2 cm)
- 30-340 DE LEE Universal Retractor 9½" (24.1 cm), Blade 2¾" (7 cm) x 2" (5.1 cm)

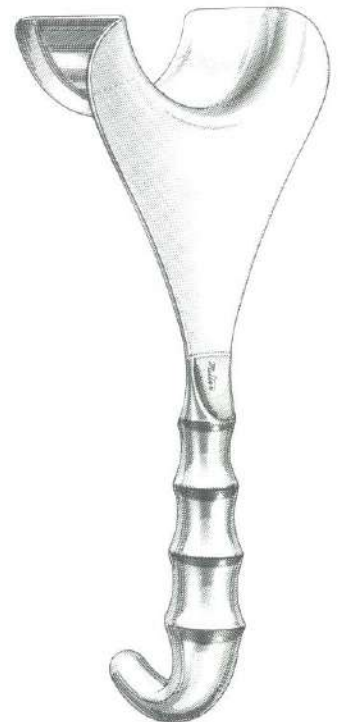

30-340



30-395 to 30-415



11-192



11-194

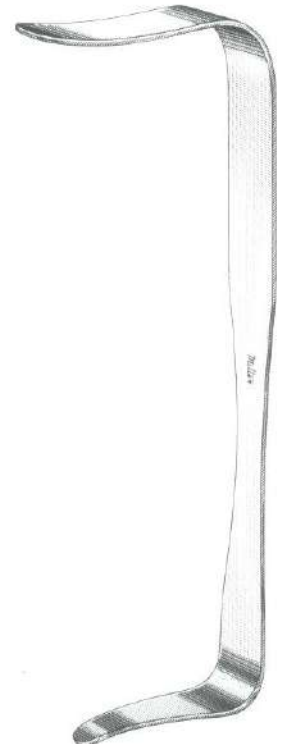

11-200

- 30-395** DOYEN Retractor 9" (22.9 cm), Blade 1¾" (4.4 cm) x 2½" (6.4 cm)
- 30-406** DOYEN Retractor 9" (22.9 cm), Blade 2⅛" (5.4 cm) x 3" (7.6 cm)
- 30-415** DOYEN Retractor 9" (22.9 cm), Blade 2¼" (5.7 cm) x 3½" (8.9 cm)

- 11-192** JUNG Mini-Chole Retractor 10½" (26.7 cm), 3 cm width blade
- 11-194** JUNG Mini-Chole Retractor 9" (22.9 cm), 4 cm width blade
- 11-196** JUNG Mini-Chole Retractors, set of 2 each of 3 cm width blade and 1 each of 4 cm width blade

- 11-200** DEEVER Retractor 1" (2.5 cm) x 9" (22.9 cm)
- 11-202** DEEVER Retractor 1" (2.5 cm) x 12" (30.5 cm)
- 11-204** DEEVER Retractor 1" (2.5 cm) x 13" (33 cm)



11-202
11-204



11-206



11-208
11-210



11-218 to 11-220



11-221 to 11-223

- | | |
|--------|---|
| 11-206 | DEAVER Retractor 1½" (3.8 cm) x 12" (30.5 cm) |
| 11-208 | DEAVER Retractor 2" (5.1 cm) x 12" (30.5 cm) |
| 11-210 | DEAVER Retractor 3" (7.6 cm) x 12" (30.5 cm) |
| 11-218 | Pediatric DEAVER Retractor 5/8" (1.6 cm) x 8½" (21.6 cm) |
| 11-219 | Pediatric DEAVER Retractor ¾" (1.9 cm) x 7" (17.8 cm) |
| 11-220 | Pediatric DEAVER Retractor 7/8" (2.2 cm) x 8" (20.3 cm) |
| 11-221 | DEAVER Retractor with Hollow Grip Handle 1" (2.5 cm) x 12" (30.5 cm) |
| 11-222 | DEAVER Retractor with Hollow Grip Handle 1" (2.5 cm) x 13" (33 cm) |
| 11-223 | DEAVER Retractor with Hollow Grip Handle 1½" (3.8 cm) x 12" (30.5 cm) |

Retractors



11-224 to 11-225



11-240 to 11-244

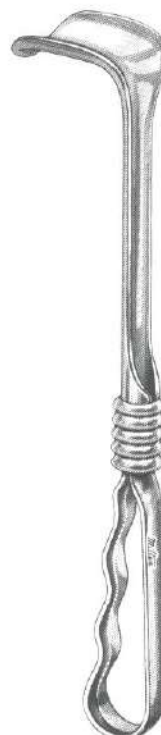

11-246 to 11-249



11-250 to 11-256

- 11-224 DEEVER Retractor with Hollow Grip Handle, 2" (5.1 cm) x 12" (30.5 cm)
 11-224A DEEVER Retractor with Hollow Grip Handle, 3" (7.6 cm) x 12" (30.5 cm)
 11-225 DEEVER Retractor with Hollow Grip Handle, 4" (10.2 cm) x 12" (30.5 cm)
- 11-240 MEYERDING Retractor 9½" (24.1 cm), large blade, 3½" (8.9 cm) x 2" (5.1 cm)
 11-242 MEYERDING Retractor 9½" (24.1 cm), medium blade, 3" (7.6 cm) x 1" (2.5 cm)
 11-244 MEYERDING Retractor 9½" (24.1 cm), small blade, 2" (5.1 cm) x 5/8" (1.6 cm)
- 11-246 RICHARDSON Retractor 9½" (24.1 cm), Loop Handle, 1" (2.5 cm) x ¾" (1.9 cm)
 11-247 RICHARDSON Retractor 9½" (24.1 cm), Loop Handle, 1¼" (3.2 cm) x 1" (2.5 cm)
 11-248 RICHARDSON Retractor 9½" (24.1 cm), Loop Handle, 1½" (3.8 cm) x 1½" (3.8 cm)
 11-249 RICHARDSON Retractor 9½" (24.1 cm), Loop Handle, 2" (5.1 cm) x ¾" (1.9 cm)
- 11-250 RICHARDSON Retractor 9½" (24.1 cm), Hollow Grip Handle, 1" (2.5 cm) x ¾" (1.9 cm)
 11-252 RICHARDSON Retractor 9½" (24.1 cm), Hollow Grip Handle, 1¼" (3.2 cm) x 1" (2.5 cm)
 11-254 RICHARDSON Retractor 9½" (24.1 cm), Hollow Grip Handle, 1½" (3.8 cm) x 1" (2.5 cm)
 11-256 RICHARDSON Retractor 9½" (24.1 cm), Hollow Grip Handle, 2" (5.1 cm) x ¾" (1.9 cm)

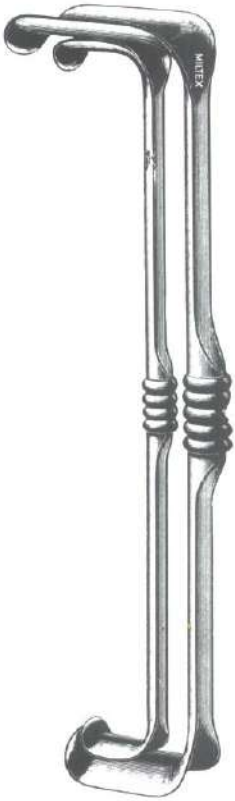

11-260 to 11-260B



11-266 to 11-269

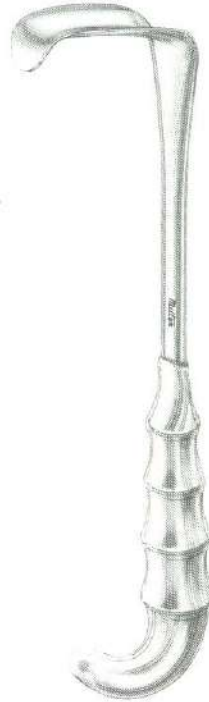

11-270 to 11-274

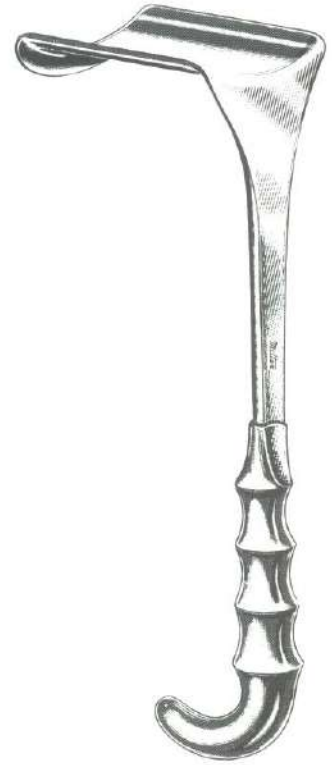

11-276

- 11-260 RICHARDSON-EASTMAN Retractor, double end, set of two
 11-260A RICHARDSON-EASTMAN Retractor, double end, 11" (27.9 cm), large size
 11-260B RICHARDSON-EASTMAN Retractor, double end, 10" (25.4 cm), small size
- 11-266 KELLY Retractor 9¾" (24.8 cm), Loop Handle, 2" (5.1 cm) x 1½" (3.8 cm)
 11-267 KELLY Retractor 9¾" (24.8 cm), Loop Handle, 2½" (6.4 cm) x 2" (5.1 cm)
 11-268 KELLY Retractor 9¾" (24.8 cm), Loop Handle, 3" (7.6 cm) x 2½" (6.4 cm)
 11-269 KELLY Retractor 9¾" (24.8 cm), Loop Handle, 3½" (8.9 cm) x 2¾" (7 cm)
- 11-270 KELLY Retractor 9½" (24.1 cm), Hollow Grip Handle, 2" (5.1 cm) x 1½" (3.8 cm)
 11-272 KELLY Retractor 10" (25.4 cm), Hollow Grip Handle, 2½" (6.4 cm) x 2" (5.1 cm)
 11-274 KELLY Retractor 10" (25.4 cm), Hollow Grip Handle, 3" (7.6 cm) x 2½" (6.4 cm)
 11-276 KELLY Retractor 10" (25.4 cm), Hollow Grip Handle, 3½" (8.9 cm) x 2¾" (7 cm)

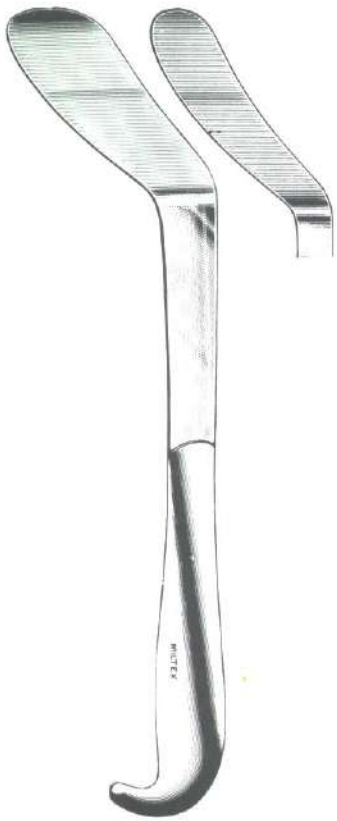

11-290
11-292



11-300



11-314 to 11-318



11-342

- 11-290 MURPHY Gall Bladder Retractor 10½" (26.7 cm), blade 1¼" (3.2 cm) wide
- 11-292 MURPHY Gall Bladder Retractor 10½" (26.7 cm), blade 2" (5.1 cm) wide
- 11-300 FOSS Gall Bladder Retractor 10" (25.4 cm), blade 1¾" (4.4 cm) wide
- 11-314 HARRINGTON Retractor 12" (30.5 cm), blade 2½" (6.4 cm) wide
- 11-316 HARRINGTON Retractor 12" (30.5 cm), blade 1½" (3.8 cm) wide
- 11-318 HARRINGTON Retractor 9½" (24.1 cm), blade 1" (2.5 cm) wide
- 11-342 FRITSCH Abdominal Retractor 9½" (24.1 cm), Hollow Grip Handle, 3" (7.6 cm) blade

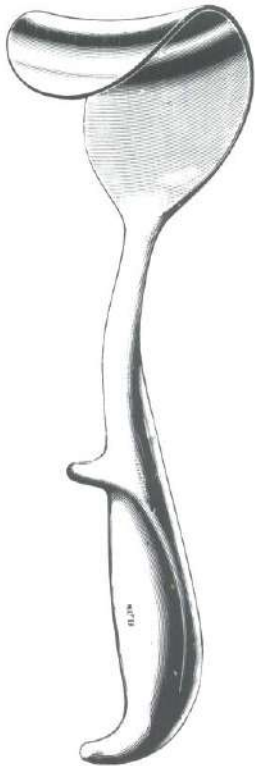

11-346



25-302



25-306

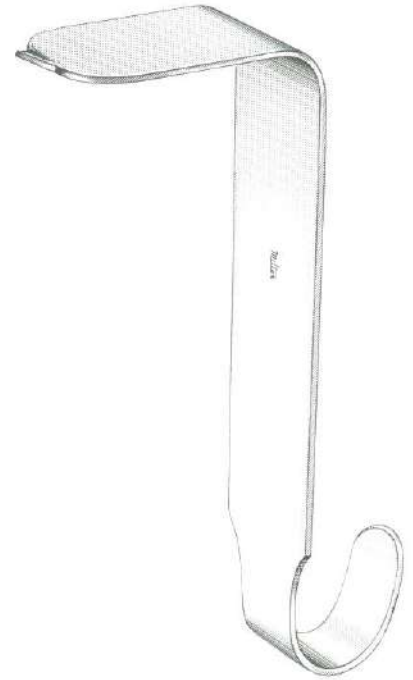

26-91
26-92

- 11-346** MAYO Abdominal Retractor 10" (25.4 cm), blade 2¾" (7 cm) wide
- 25-302** ALLISON Lung Retractor 12¾" (32.4 cm), standard size 2" (5.1 cm) wide blade
- 25-306** DAVIDSON Scapula Retractor, blade 3½" (8.9 cm) wide x 3¼" (8.3 cm) deep
- 26-91** TAYLOR Spinal Retractor 7¼" (18.4 cm), blade 1¼" (3.2 cm) x 3" (7.6 cm)
- 26-92** TAYLOR Spinal Retractor 8" (20.3 cm), blade 1¼" (3.2 cm) x 4" (10.2 cm)



28-70 to 28-74

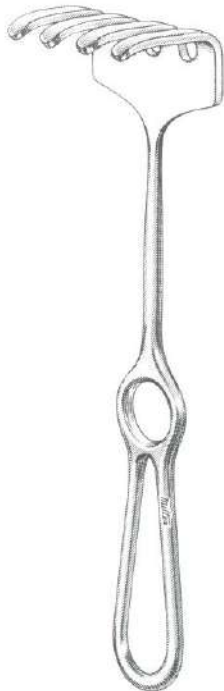

11-349



11-350
11-352

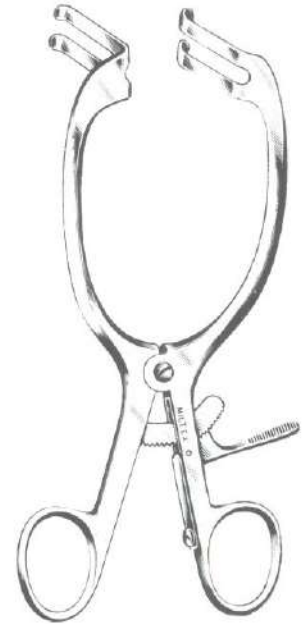

11-360

- 28-70 SAWYER Retractor 11" (27.9 cm), blade $\frac{7}{8}$ " (2.2 cm) x $2\frac{1}{2}$ " (6.4 cm)
- 28-72 SAWYER Retractor 11" (27.9 cm), blade $1\frac{1}{8}$ " (2.8 cm) x 3" (7.6 cm)
- 28-74 SAWYER Retractor 11" (27.9 cm), blade $1\frac{1}{2}$ " (3.8 cm) x $3\frac{1}{2}$ " (8.9 cm)
- 11-349 OLLIER Retractor $8\frac{1}{2}$ " (21.6 cm), blunt, 4 prongs $2\frac{1}{4}$ " (5.7 cm) x $1\frac{3}{4}$ " (4.4 cm)
- 11-350 ISRAEL Retractor 9" (22.9 cm), blunt, 4 prongs $1\frac{1}{2}$ " (3.8 cm) x $1\frac{5}{8}$ " (4.1 cm)
- 11-352 ISRAEL Retractor 9" (22.9 cm), blunt, 6 prongs $2\frac{1}{4}$ " (5.7 cm) x $1\frac{3}{4}$ " (4.4 cm)
- 11-360 MAYO-ADAMS Retractor $6\frac{3}{4}$ " (17.1 cm), with grip lock
- 11-362 MAYO-ADAMS Retractor $6\frac{3}{4}$ " (17.1 cm), with center blade and grip lock

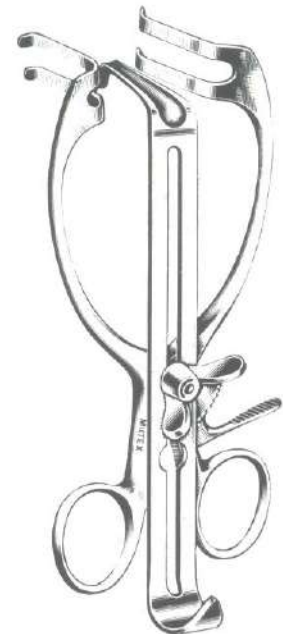

11-362



26-1973



26-2000
26-2001
26-2005

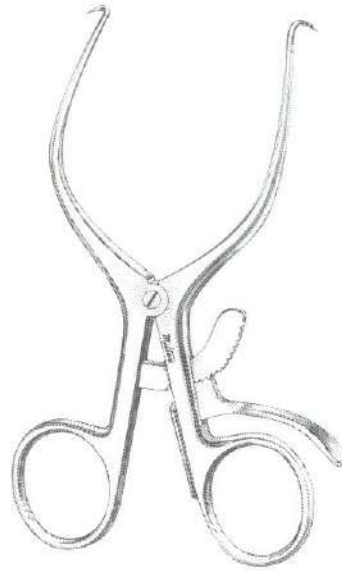

11-365
11-366

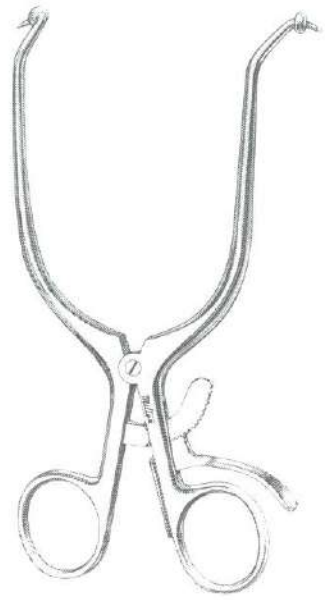

11-368

- 26-1973** BECKMAN-EATON Laminectomy Retractor 12 $\frac{3}{4}$ " (32.4 cm), hinged, sharp 7 x 7 teeth 1 $\frac{3}{4}$ " (4.4 cm) wide x 2" (5.1 cm) deep
- 26-2000** INGE Lamina Spreader 6" (15.2 cm), jaws open to 1 $\frac{1}{8}$ " (2.8 cm)
- 26-2001** INGE Lamina Spreader 6" (15.2 cm), jaws open to 1 $\frac{1}{8}$ " (2.8 cm), without teeth
- 26-2005** INGE Lamina Spreader 9 $\frac{1}{2}$ " (24.1 cm), jaws open to 1 $\frac{3}{4}$ " (4.4 cm), smooth handles
- 11-365** Pediatric GELPI Retractor 5 $\frac{1}{2}$ " (14 cm), with grip lock
- 11-366** GELPI Retractor 6 $\frac{3}{4}$ " (17.1 cm), with grip lock
- 11-368** GELPI Retractor 6 $\frac{3}{4}$ " (17.1 cm), with ball stops and grip lock
- 11-374** RIGBY Appendectomy Retractor 6 $\frac{3}{4}$ " (17.1 cm), with grip lock



11-374

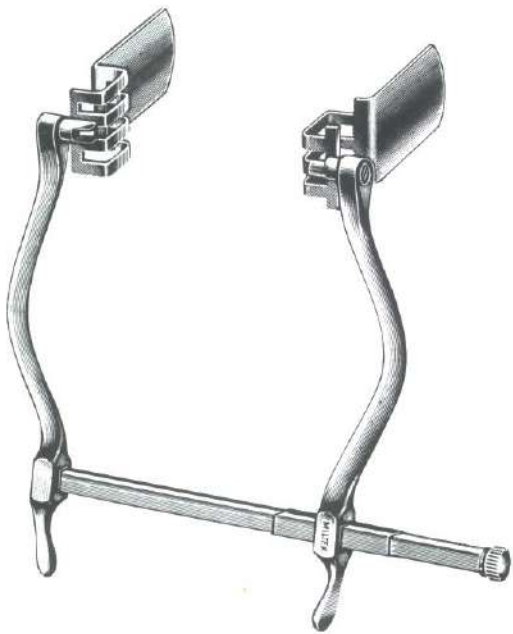

11-390

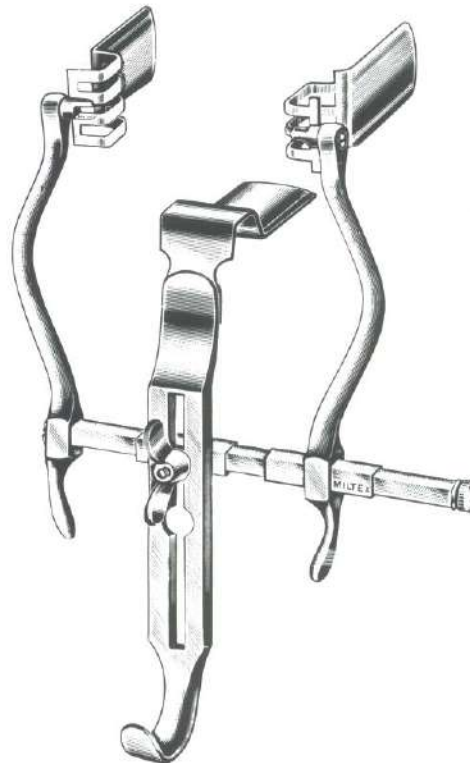

11-392



28-6

11-390 MASSON-JUDD Bladder Retractor with 2 swivel blades 1" (2.5 cm) x 2¾" (7 cm)

11-392 MASSON-JUDD Bladder Retractor with 2 swivel blades and center blade 1" (2.5 cm) x 2¾" (7 cm)

28-6 BARR Anal Retractor 8" (20.3 cm), self-retaining, blades 2¾" (7 cm) x 7/8" (2.2 cm)

28-8 COOK Rectal Retractor 8" (20.3 cm), triple bladed, self-retaining, 4" (10.2 cm) deep blades, lower blade ½" (1.3 cm) wide



28-8

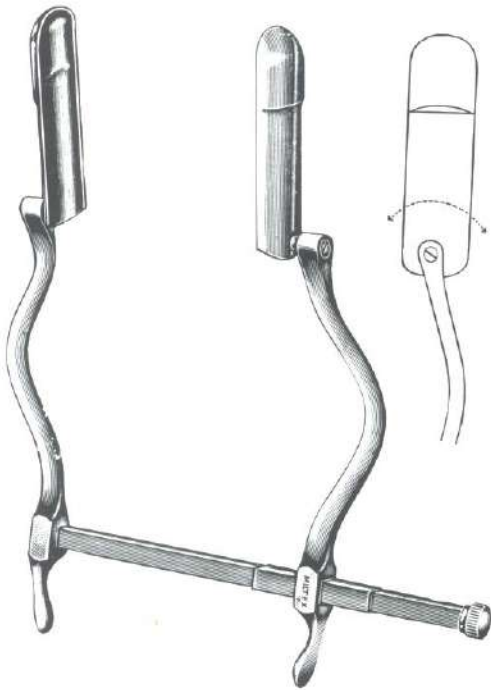

28-64
28-65

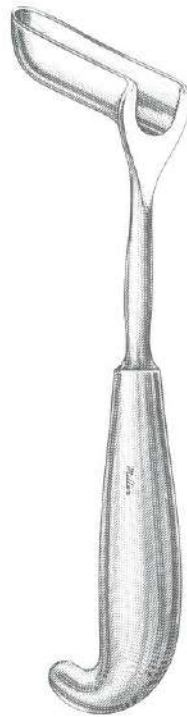

28-68
28-69



11-400 to 11-404

- 28-64 SMITH (BUIE) Anal Retractor, self-retaining, swivel blades 2½" (6.4 cm) x 7⁄8" (2.2 cm) open to 4" (10.2 cm)
- 28-65 SMITH (BUIE) Anal Retractor, self-retaining, extra long swivel blades 4" (10.2 cm) x 7⁄8" (2.2 cm) open to 4" (10.2 cm)
- 28-68 HILL-FERGUSON Retractor 8½" (21.6 cm), small blade 2.2 x 6.4 cm
- 28-69 HILL-FERGUSON Retractor 8¾" (21 cm), large blade 3 x 7.6 cm
- 11-400 GOSSET Retractor 4" (10.2 cm) spread, 1" (2.5 cm) x 1½" (3.8 cm) blades
- 11-402 GOSSET Retractor 5½" (14 cm) spread, 1" (2.5 cm) x 2½" (6.4 cm) blades
- 11-404 Pediatric GOSSET Retractor 3½" (8.9 cm) spread, ¾" (1.9 cm) x 1" (2.5 cm) blades, light pattern

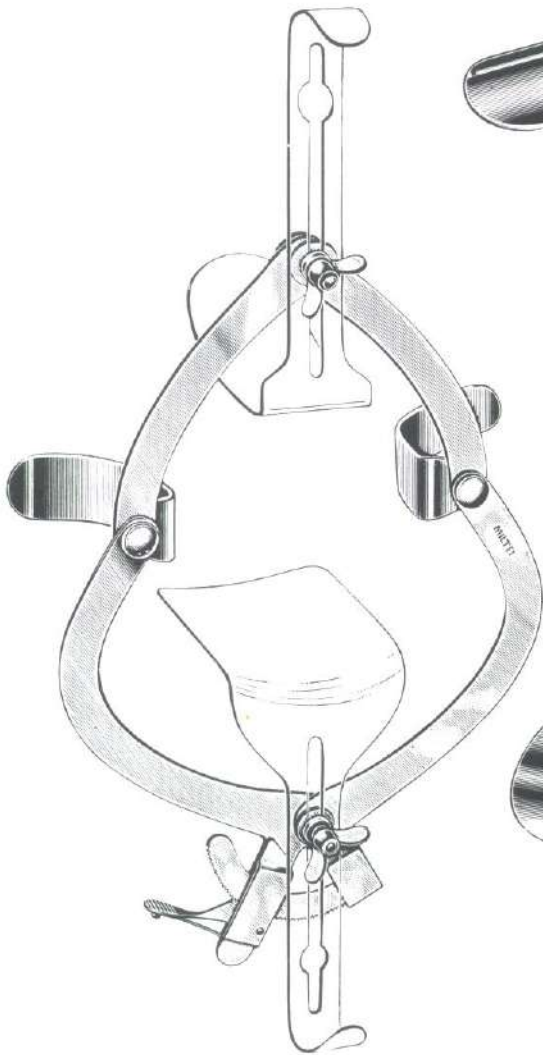

11-410



Large



Small

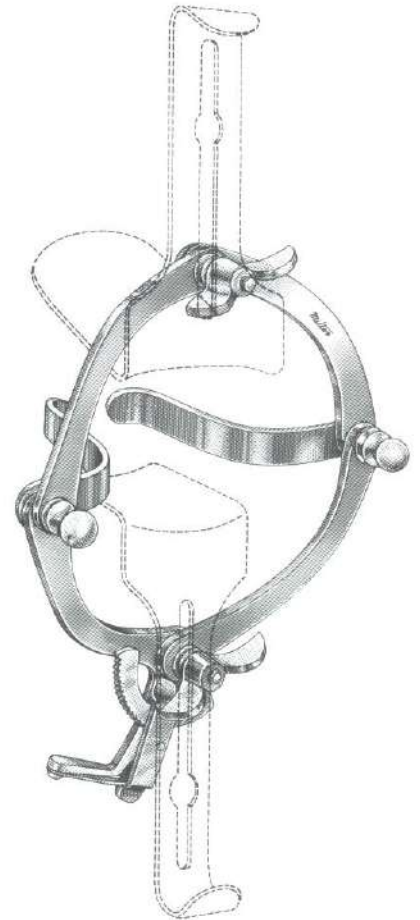

30-370

11-410 O'SULLIVAN-O'CONNOR Abdominal Retractor, with 3 interchangeable blades, two small size $1\frac{3}{4}$ " (4.4 cm) x $3\frac{1}{4}$ " (8.3 cm), one large size $2\frac{3}{4}$ " (7 cm) x $4\frac{1}{4}$ " (10.8 cm)

30-370 O'SULLIVAN-O'CONNOR Vaginal Retractor, with 3 interchangeable blades, $\frac{1}{2}$ " (1.3 cm) x $1\frac{7}{8}$ " (4.7 cm), $1\frac{1}{2}$ " (3.8 cm) x $3\frac{1}{2}$ " (8.9 cm) and $1\frac{3}{4}$ " (4.4 cm) x $3\frac{1}{2}$ " (8.9 cm)



11-414

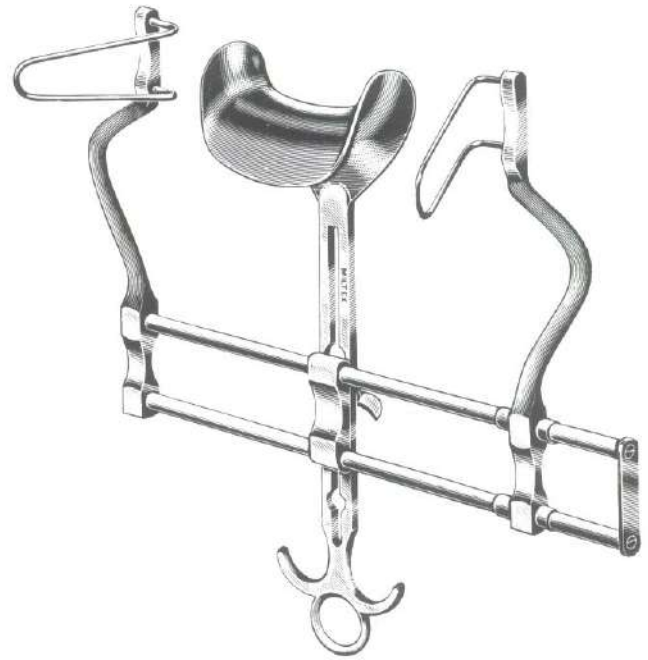

11-420
11-421

11-414 COLLIN Abdominal Retractor 9" (22.9 cm), with 2 swivel blades

BALFOUR ABDOMINAL RETRACTORS
with fenestrated side blades 2½" (6.4 cm) deep and solid center blade 3" (7.6 cm) x 1¾" (4.4 cm) deep

11-420 7" (17.8 cm) spread (standard size)

11-421 10" (25.4 cm) spread

11-424 BALFOUR Abdominal Retractor, with solid side blades 2¾" (7 cm) deep and solid center blade 3" (7.6 cm) x 1¾" (4.4 cm) deep, 7" (17.8 cm) spread

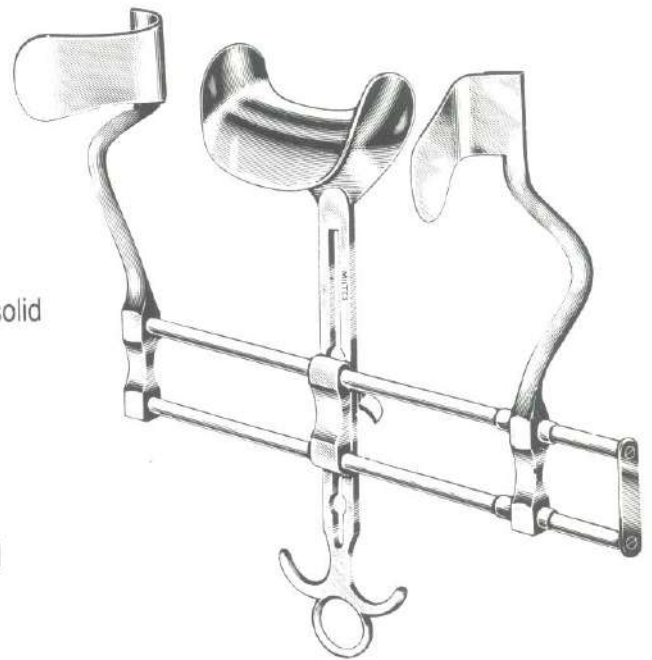

11-424



11-428

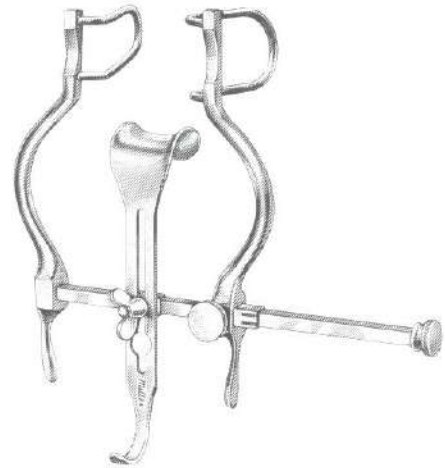

11-430



11-432

11-428 BALFOUR Abdominal Retractor, with fenestrated side blades 4" (10.2 cm) deep solid center blade 2³/₄" (7 cm) x 4" (10.2 cm) deep, 7" (17.8 cm) spread

11-430 Pediatric BALFOUR Abdominal Retractor, with fenestrated side blades and solid center blade 1" (2.5 cm) deep, 4" (10.2 cm) spread, light pattern

11-432 BALFOUR Abdominal Retractor with ratchet bar, 2 pair interchangeable fenestrated side blades 2¹/₄" (5.7 cm) and 3¹/₂" (8.9 cm) deep and 2 solid center blades 2⁵/₈" (6.7 cm) x 1³/₄" (4.4 cm) and 3¹/₄" (8.3 cm) x 2³/₄" (7 cm), 7" (17.8 cm) spread



11-442

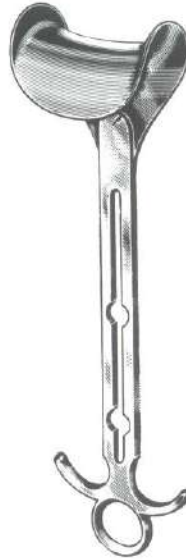

11-440
11-444
11-446

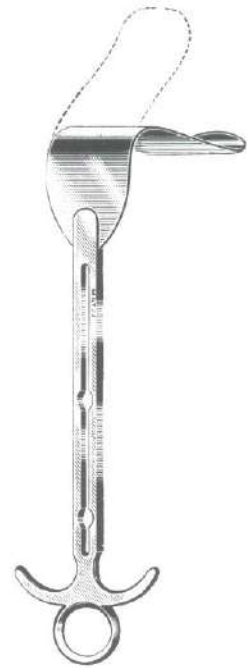

11-448

- 11-440 BALFOUR Center Blade, standard size 3" (7.6 cm) x 1 $\frac{3}{4}$ " (4.4 cm) deep
- 11-442 BALFOUR Center Blade, extra deep model, 2 $\frac{3}{4}$ " (7 cm) x 4" (10.2 cm) deep
- 11-444 BALFOUR Center Blade, 2 $\frac{5}{8}$ " (6.7 cm) x 1 $\frac{3}{4}$ " (4.4 cm) deep
- 11-446 BALFOUR Center Blade, 3 $\frac{1}{4}$ " (8.3 cm) x 2 $\frac{3}{4}$ " (7 cm) deep
- 11-448 BALFOUR Center Blade, 2" (5.1 cm) x 5" (12.7 cm) deep, malleable

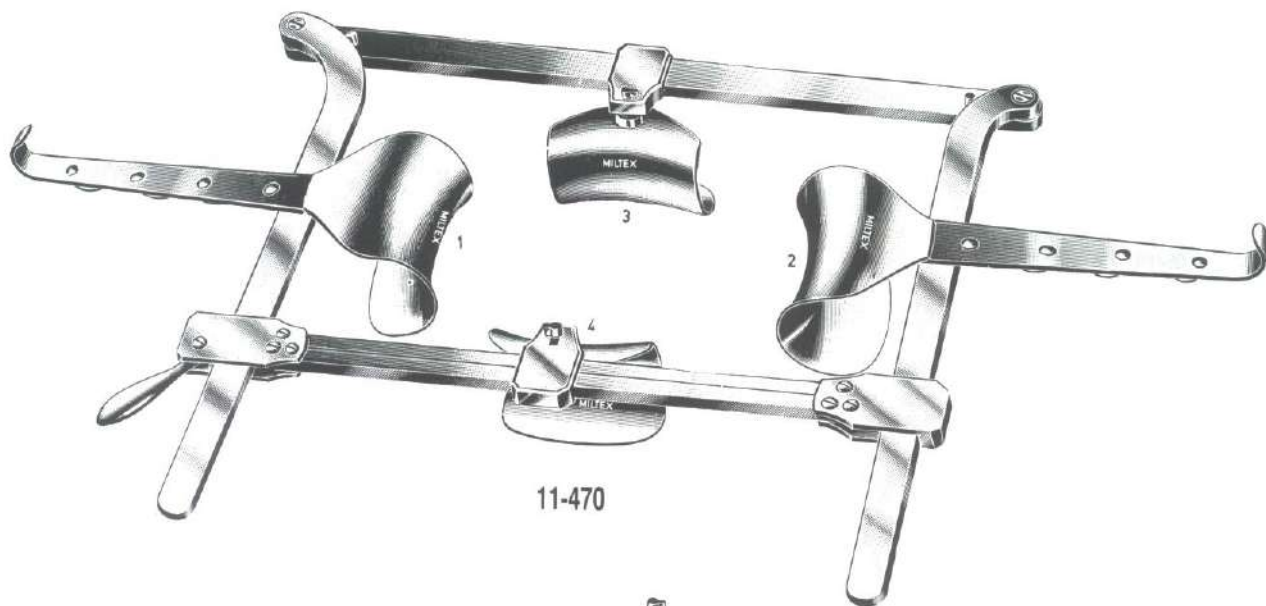

11-470

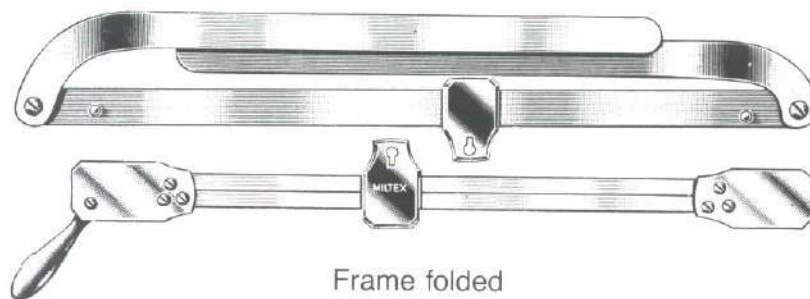
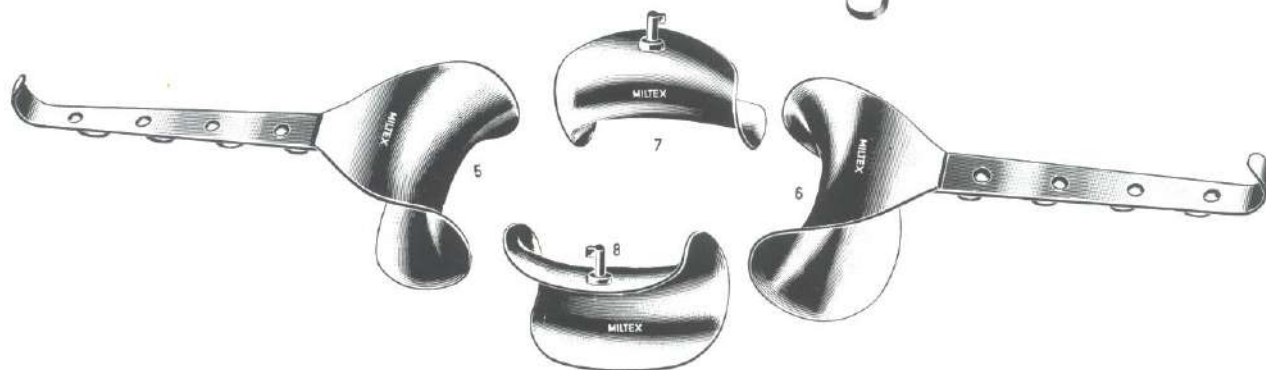

Frame folded

11-470 FRANZ Abdominal Retractor, with 8 interchangeable blades, folding for easy storage.

Blades No. 1 and 2 – 2" (5.1 cm) x 1¾" (4.4 cm) deep

Blades No. 3 and 4 – 2½" (6.4 cm) x 1¼" (3.2 cm) deep

Blades No. 5 and 6 – 3" (7.6 cm) x 2" (5.1 cm) deep

Blades No. 7 and 8 – 3½" (8.9 cm) x 1¼" (3.2 cm) deep



11-500



11-502



27-230
27-232

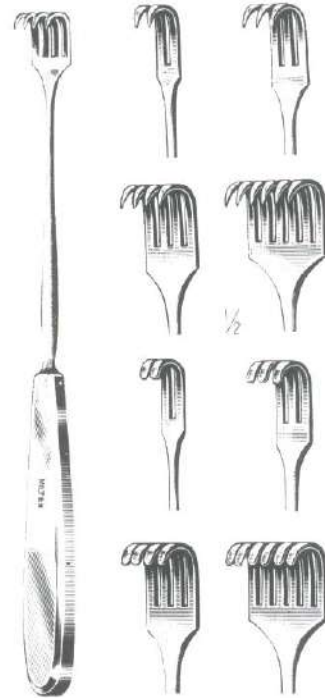

11-504 to 11-516



11-530 to 11-544

- 11-500** VOLKMAN Hook 8½" (21.6 cm), sharp, hollow handle
11-502 VOLKMAN Hook 8½" (21.6 cm), sharp, ring handle
27-230 VOLKMAN Hook Retractor 9" (22.9 cm), sharp point 15 mm deep
27-232 VOLKMAN Hook Retractor 9" (22.9 cm), blunt tip 15 mm deep

VOLKMAN RETRACTORS 8½" (21.6 cm), Hollow Handle

Sharp		Blunt
11-504	2 prongs	11-512
11-506	3 prongs	11-514
11-508	4 prongs	11-516

VOLKMAN RETRACTORS 8" (20.3 cm), Ring Handle

Sharp		Blunt
11-530	2 prongs	11-538
11-532	3 prongs	11-540
11-534	4 prongs	11-542
11-536	6 prongs	11-544

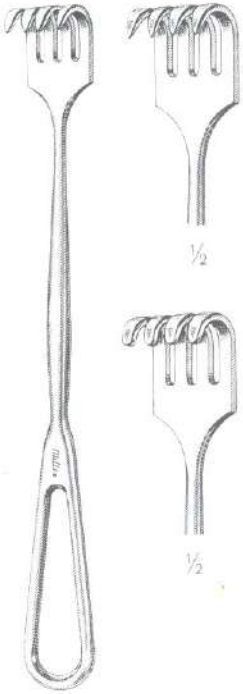

11-546 to 11-554

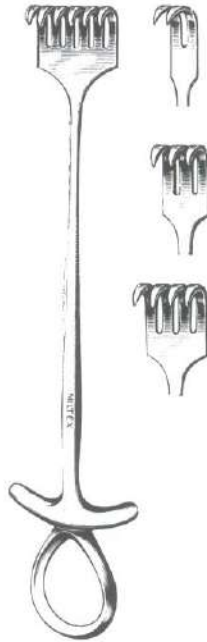

11-560 to 11-566

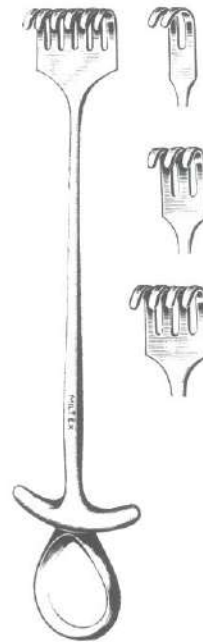

11-568 to 11-574



11-580
11-582

VOLKMAN RETRACTORS 8³/₄" (22.2 cm), USA Pattern Ring Handle

	Sharp	Blunt
11-546	2 prongs	11-551
11-547	3 prongs	11-552
11-548	4 prongs	11-553
11-549	6 prongs	11-554

MURPHY RETRACTORS 7¹/₂" (19.1 cm)

	Sharp	Blunt
11-560	2 prongs	11-568
11-562	3 prongs	11-570
11-564	4 prongs	11-572
11-566	6 prongs	11-574

- 11-580 BENNETT Tibia Retractor 9¹/₂" (24.1 cm), small blade 1³/₄" (4.4 cm) wide
- 11-582 BENNETT Tibia Retractor 9¹/₂" (24.1 cm), large blade 2¹/₂" (6.4 cm) wide
- 11-590 HIBBS Retractor 9¹/₄" (23.5 cm), blade 1" (2.5 cm) x 3" (7.6 cm) deep



11-590



27-213
27-214



27-215 to 27-218

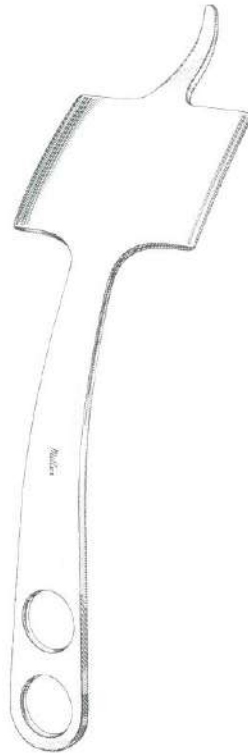

27-219

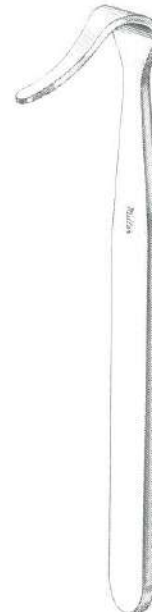

27-223

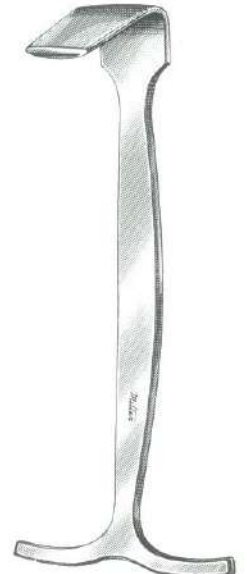

27-224

- 27-213 MINI-HOHMANN Retractor 6¼" (15.9 cm), blade 6 mm wide
- 27-214 MINI-HOHMANN Retractor 6¼" (15.9 cm), blade 8 mm wide

- 27-215 HOHMANN Retractor 9¼" (23.5 cm), blade 10 mm wide
- 27-216 HOHMANN Retractor 9¼" (23.5 cm), blade 18 mm wide
- 27-217 HOHMANN Retractor 9¼" (23.5 cm), blade 25 mm wide
- 27-218 HOHMANN Retractor 9¼" (23.5 cm), blade 43 mm wide
- 27-219 HOHMANN Retractor 9¾" (24.8 cm), blade 70 mm wide

- 27-223 BLOUNT Knee Retractor 7" (17.8 cm), blade 1¾" (4.4 cm) deep, 5⁄8" (1.6 cm) wide tapering to 3⁄16" (.48 cm)

- 27-224 SMILLIE Meniscus Hook Retractor 5¾" (14.6 cm), blade ¾" (1.9 cm) x 1¾" (3.5 cm)

- 27-225 HAYS Hand and Finger Retractor 6" (15.2 cm), angled blade 1½" (3.8 cm) long, 3⁄8" (1 cm) wide tapering to 1⁄8" (.32 cm)



27-225

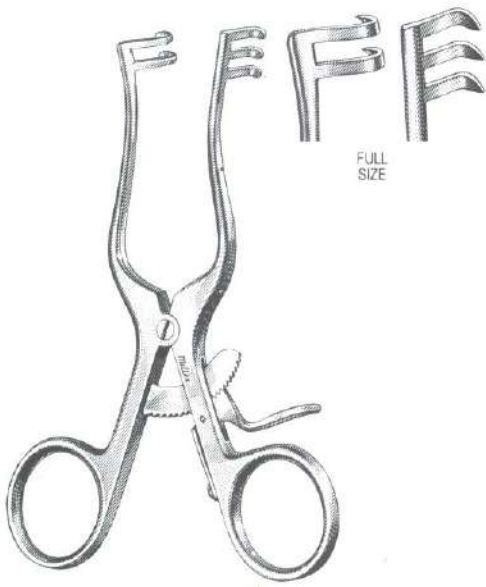

11-600 to 11-602

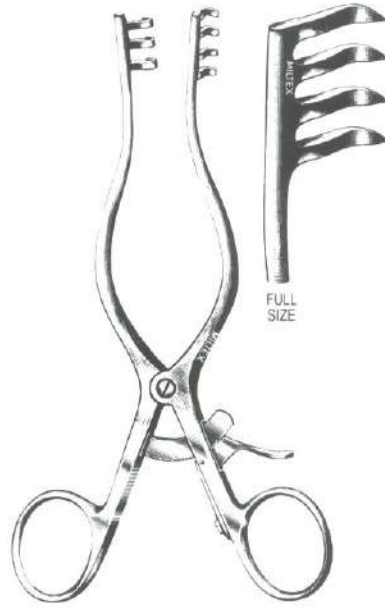

11-608 to 11-610
11-614 to 11-622

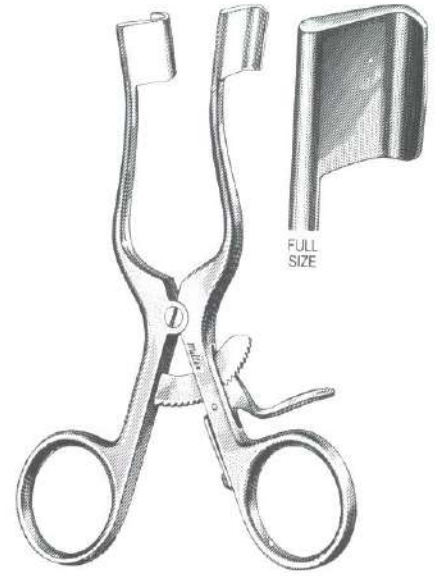

11-611

WEITLANER RETRACTORS

Sharp	Size	Blunt
11-600	4" (10.2 cm) 2 x 3 teeth	11-602
11-608	5½" (14 cm) 3 x 4 teeth	11-610
—	5½" (14 cm) solid blades	11-611
11-614	6½" (16.5 cm) 3 x 4 teeth	11-616
11-617	8" (20.3 cm) 3 x 4 teeth	11-618
11-620	9½" (24.1 cm) 3 x 4 teeth	11-622

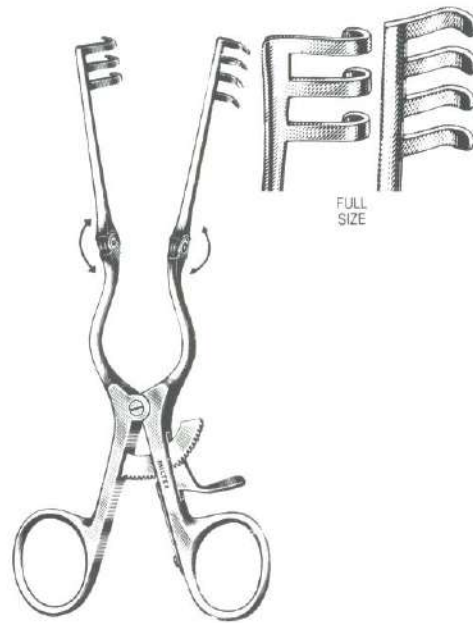

11-630 to 11-642



40-1235

BECKMAN-WEITLANER RETRACTORS, with Hinged Blades

Sharp	Size	Blunt
11-630-SH	5½" (14 cm) 3 x 4 teeth	11-630-BL
11-634-SH	6½" (16.5 cm) 3 x 4 teeth	11-634-BL
11-642-SH	9" (22.9 cm) 3 x 4 teeth	11-642-BL

40-1235 SCHINK Retractor 4½" (11.4 cm)

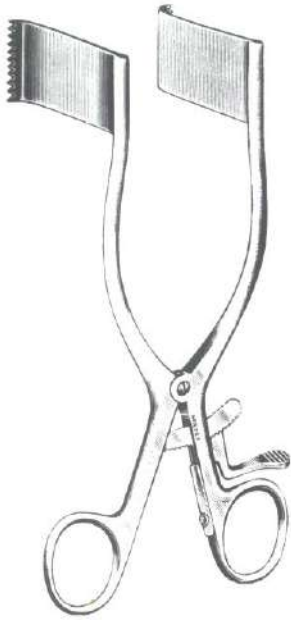

11-650 to 11-656



19-655



19-660

MEYERDING SELF-RETAINING RETRACTORS

- 11-650** 1" (2.5 cm) x 2³/₈" (6.1 cm) blades
- 11-652** 1" (2.5 cm) x 2¹/₈" (5.4 cm) blades
- 11-654** 1" (2.5 cm) x 1³/₄" (4.4 cm) blades
- 11-656** 3/4" (1.9 cm) x 2³/₈" (6.1 cm) blades
- 19-655** SCHUHKNECHT Postauricular Retractor 5" (12.7 cm),
3 x 3 teeth, 3" (7.6 cm) opening
- 19-660** WULLSTEIN Endaural Retractor 5" (12.7 cm),
3 x 3 sharp teeth, ebony non-glare finish
- 19-668** PERKINS Endaural Retractor 5¹/₄" (13.3 cm),
left serrated solid blade, right side 3 teeth
- 19-669** PERKINS Endaural Retractor 5¹/₄" (13.3 cm),
right serrated solid blade, left side 3 teeth

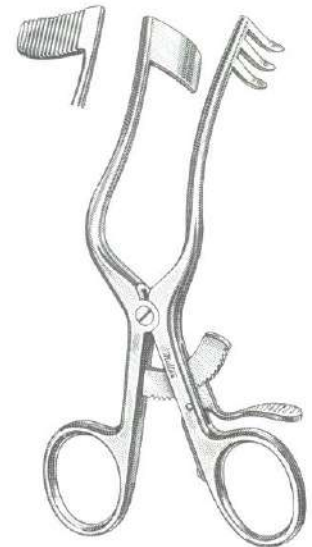

19-668

19-669



11-660



11-672

11-660 FRAZIER Retractor, 3 x 4 blunt teeth, 3/4" (8.3 cm) spread

11-672 BADGLEY Retractor, 4 x 4 blunt teeth, 2" (5.1 cm) x 1 3/4" (4.4 cm), 6 1/2" (16.5 cm) spread

11-676 TUFFIER Retractor, 2" (5.1 cm) x 1 3/4" (4.4 cm), grooved blades, 6 1/2" (16.5 cm) spread



11-676



11-684
11-686

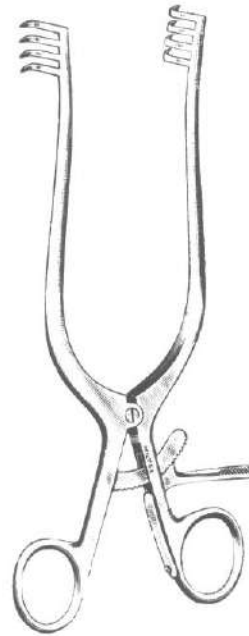

11-700

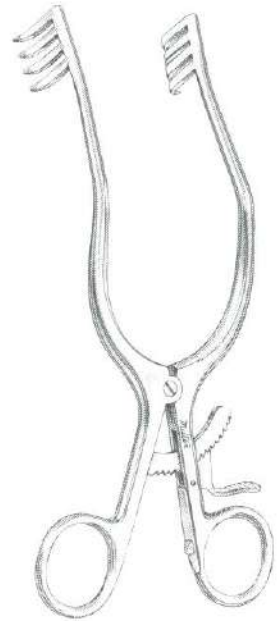

11-702



30-1355

- 11-684 BECKMAN Retractor 12½" (31.8 cm), hinged, sharp 4 x 4 teeth ¾" (1.9 cm) x 1" (2.5 cm)
- 11-686 BECKMAN Retractor 12½" (31.8 cm), hinged, sharp 4 x 4 teeth 1¾" (4.4 cm) x 1¼" (3.2 cm)
- 11-700 ADSON Retractor 7½" (19.1 cm), sharp, 4 x 4 teeth ¾" (1.9 cm) x ¾" (1.9 cm), straight arms
- 11-702 ADSON Retractor 7½" (19.1 cm), sharp, 4 x 4 teeth ¾" (1.9 cm) x ¾" (1.9 cm), angled arms
- 30-1355 Lateral Vaginal Retractor 8¼" (21 cm), with extra long thumb ratchet retracts up to a full 2¼" (5.7 cm) for an extra wide viewing area

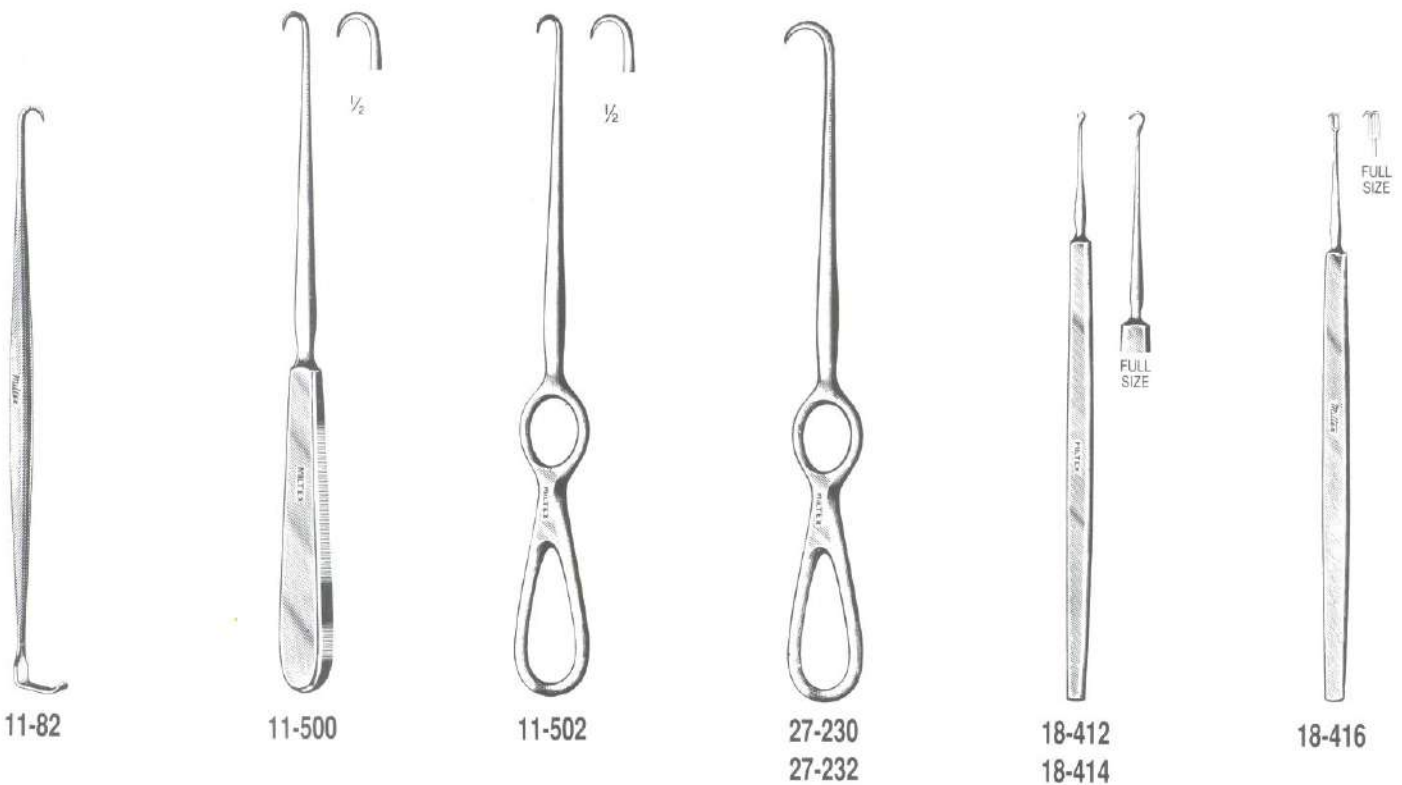

- 11-82 MEYERDING Skin Hook and Retractor 6¼" (15.9 cm), double end
- 11-500 VOLKMAN Hook 8½" (21.6 cm), sharp, hollow handle
- 11-502 VOLKMAN Hook 8½" (21.6 cm), sharp, ring handle
- 27-230 VOLKMAN Hook Retractor 9" (22.9 cm), sharp point 15 mm deep
- 27-232 VOLKMAN Hook Retractor 9" (22.9 cm), blunt tip 15 mm deep
- 18-412 TYRELL Hook 5" (12.7 cm), sharp
- 18-414 TYRELL Hook 5" (12.7 cm), blunt
- 18-416 GUTHRIE Fixation Hook 5" (12.7 cm), sharp double prongs 1.5 mm wide



- 18-418** WIENER Hook 5" (12.7 cm), sharp
- 18-420** WIENER Hook 5" (12.7 cm), blunt
- 18-424** O'CONNOR Hook 4¾" (12.1 cm), sharp
- 18-428** NUGENT Hook 4¾" (12.1 cm), right angle, sharp
- 18-440** STEVENS Hook 5" (12.7 cm), right angle 5 mm deep
- 18-442** GREEN Hook 5" (12.7 cm), 9 mm deep
- 18-446** JAMESON Hook 5" (12.7 cm), 10 mm deep
- 18-450** VON GRAEFE Hook 5½" (14 cm), small size 8 mm deep
- 18-452** VON GRAEFE Hook 5½" (14 cm), medium size 10 mm deep
- 18-454** VON GRAEFE Hook 5½" (14 cm), large size 11 mm deep



- 19-220 DAY Hook 6½" (16.5 cm), small size
- 19-222 DAY Hook 6½" (16.5 cm), large size
- 19-226 ALLPORT Hook 6½" (16.5 cm), with ball tip
- 19-228 GROSS Hook and Spoon 5" (12.7 cm)
- 21-85 KLEINERT-KUTZ Hook 5" (12.7 cm), small size 3 mm dia.
- 21-86 KLEINERT-KUTZ Hook 5" (12.7 cm), medium size 5 mm dia.
- 21-87 KLEINERT-KUTZ Hook 5" (12.7 cm), large size 7 mm dia.
- 21-88 GILLIES (CONVERSE) Skin Hook 7" (17.8 cm), large size
- 21-89 GILLIES (CONVERSE) Skin Hook 7" (17.8 cm), small size
- 21-90 COTTLE Skin Hook 5½" (14 cm), small, shallow curve
- 21-92 COTTLE Skin Hook 5½" (14 cm), small, deep curve
- 21-94 COTTLE Skin Hook 5½" (14 cm), large, deep curve
- 26-1084 FRAZIER Dura Hook 5" (12.7 cm), sharp point
- 26-1086 FRAZIER Dura Hook 5" (12.7 cm), blunt point



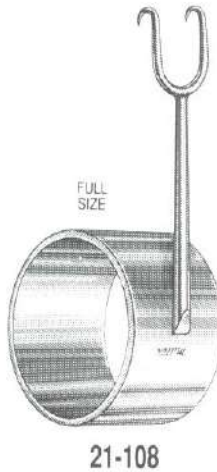
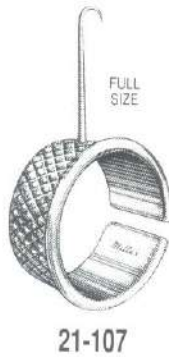

21-102
21-103

21-107

21-108

21-144

21-152

21-153

- 21-102 FREER Skin Hook 6" (15.2 cm), sharp double prongs 2.5 mm wide
- 21-103 FREER Skin Hook 6" (15.2 cm), blunt double prongs 2.5 mm wide
- 21-107 MILLARD Thimble Hook Retractor, 5/8" (1.6 cm) working length, sharp single hook
- 21-108 COTTLE Thumb Hook Retractor, 1 1/2" (3.8 cm) working length, sharp double hook 8 mm wide
- 21-144 COTTLE Double Hook 5 1/2" (14 cm), two sharp prongs 12 mm wide
- 21-152 MILTEX Skin Hook 4 3/4" (12.1 cm), sharp prong 2 mm dia.
- 21-153 JOSEPH Single Hook 6 1/4" (15.9 cm), one sharp prong
- 21-154 JOSEPH Double Hook 6 1/4" (15.9 cm), two sharp prongs 2 mm
- 21-156 JOSEPH Double Hook 6 1/4" (15.9 cm), two sharp prongs 5 mm
- 21-158 JOSEPH Double Hook 6 1/4" (15.9 cm), two sharp prongs 7 mm
- 21-160 JOSEPH Double Hook 6 1/4" (15.9 cm), two sharp prongs 10 mm

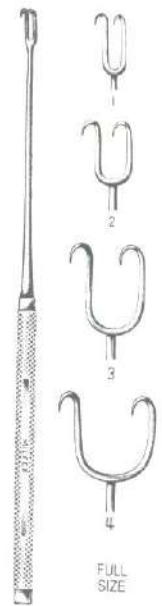

21-154 to 21-160



21-430



23-1048



23-1050



23-1051



26-1080



26-1090
26-1092

- 21-430 MILTEX Tissue Twist Hook 5½" (14 cm)
- 23-1048 HUPP Hook 6½" (16.5 cm), sharp point
- 23-1050 JACKSON Tenaculum Hook 5¾" (14.6 cm), sharp point
- 23-1051 NEWS Hook 6" (15.2 cm), sharp point
- 26-1080 CUSHING Dura Hook 6½" (16.5 cm), blunt
- 26-1090 ADSON Dura & Dissecting Hook 8" (20.3 cm), sharp blade 5 mm at right angle
- 26-1092 ADSON Dura Hook 8" (20.3 cm), blunt 5 mm hook at right angle

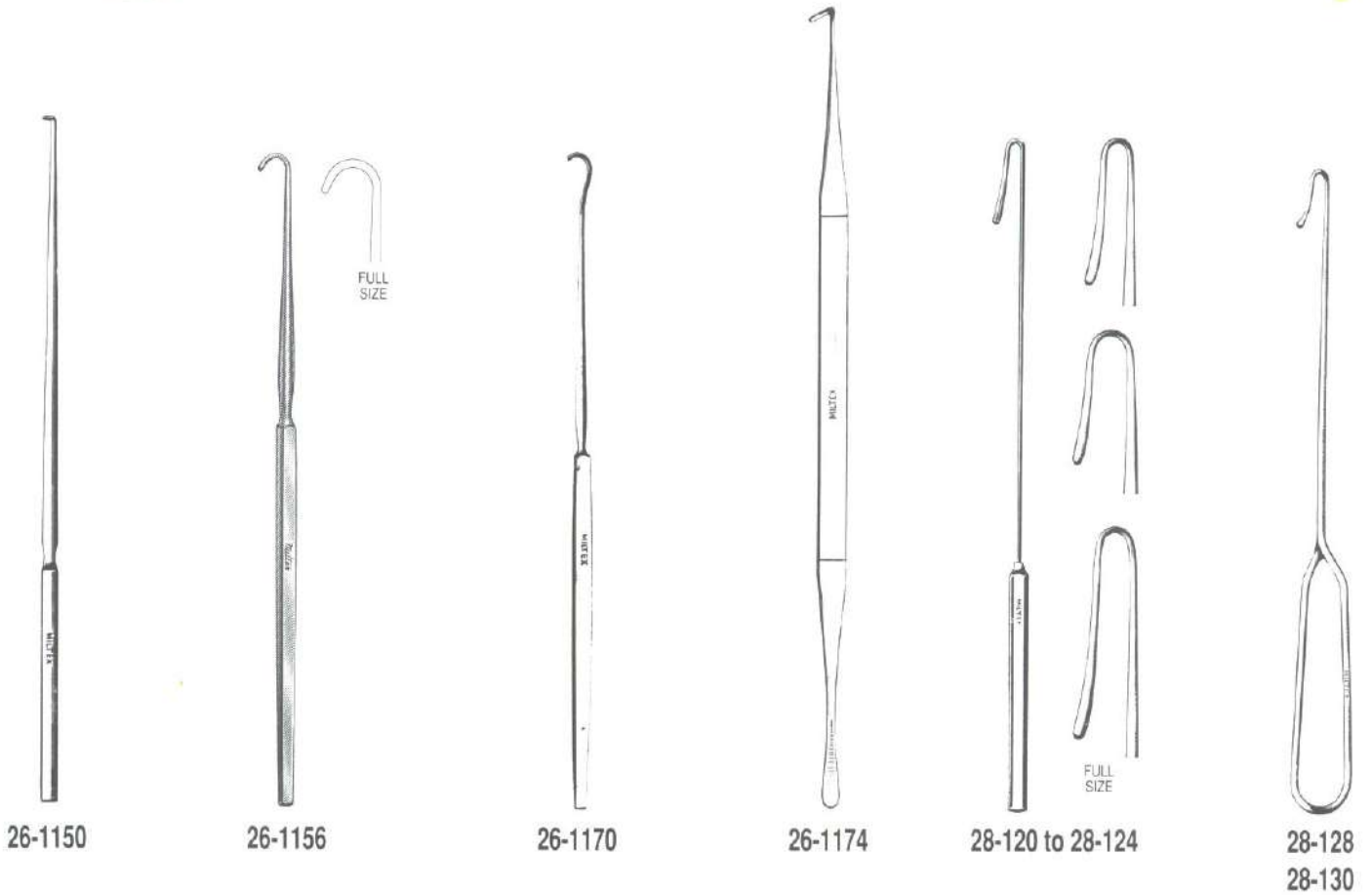

- 26-1150 DANDY Hook 9" (22.9 cm), straight
- 26-1156 GRAHAM Hook 7" (17.8 cm), blunt, 6 mm deep
- 26-1170 SMITHWICK Hook 7" (17.8 cm), blunt, 10 mm deep
- 26-1174 SMITHWICK Hook and Dissector 12" (30.5 cm)
- 28-120 PRATT Crypt Hook 8½" (21.6 cm), narrow style
- 28-122 PRATT Crypt Hook 8½" (21.6 cm), short style
- 28-124 PRATT Crypt Hook 8½" (21.6 cm), long style
- 28-128 STEWART Crypt Hook 8½" (21.6 cm), short style
- 28-130 STEWART Crypt Hook 8½" (21.6 cm), long style

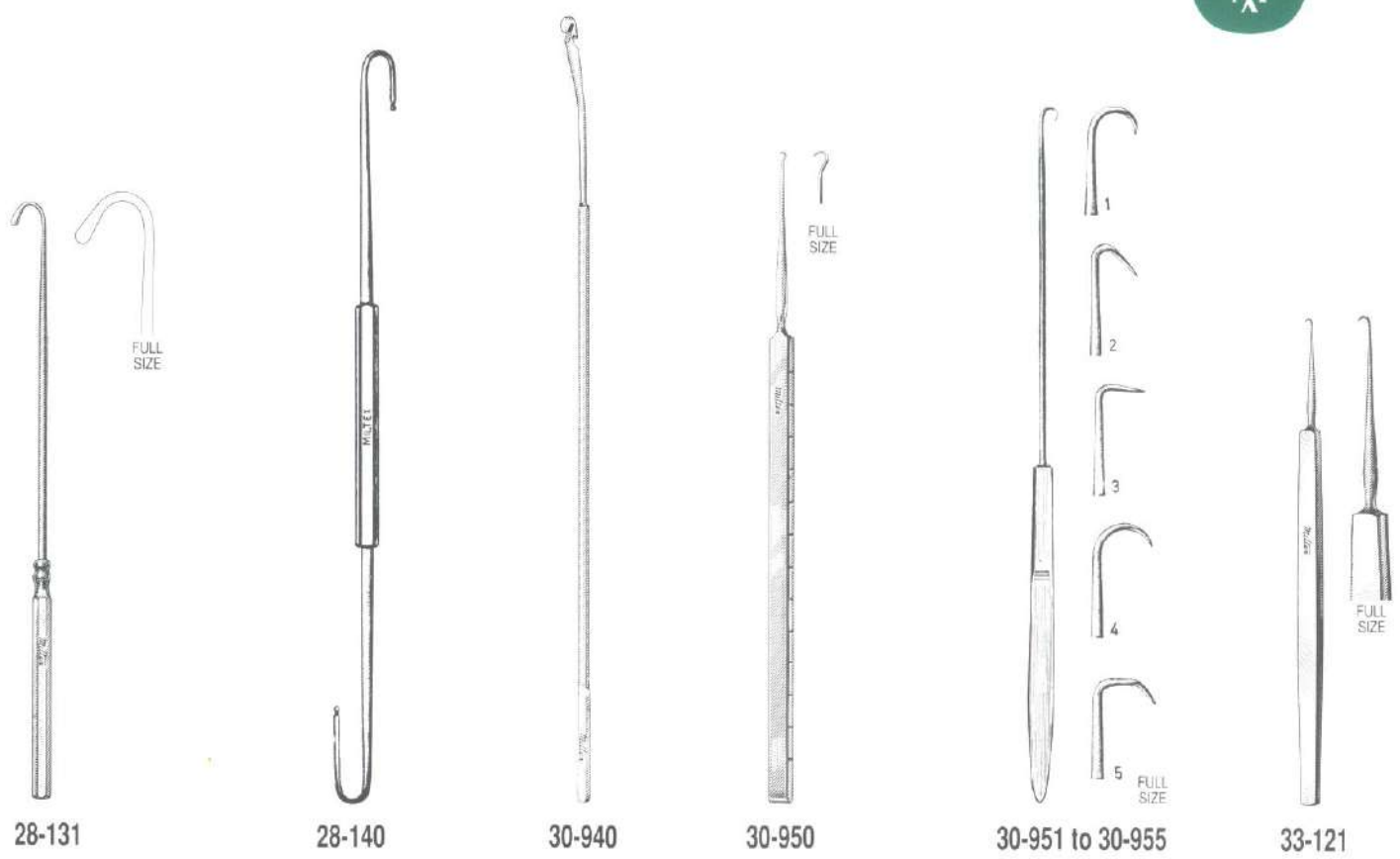

- 28-131** ROSSER Crypt Hook 6¾" (17.1 cm)
- 28-140** BARR Crypt Hook 10" (25.4 cm), short and long hook ends
- 30-940** MILTEX I.U.D. Extractor Hook 10¼" (26 cm)
- 30-950** MILTEX Tenaculum Hook 8" (20.3 cm), extra delicate pointed hook, handle graduated in cm
- EMMETT TENACULUM HOOKS 9" (22.9 cm), Sharp Points
 - 30-951** Style 1 Half-Curved, small **30-954** Style 4 Half-Curved, large
 - 30-952** Style 2 Acute Angle **30-955** Style 5 Double Angle
 - 30-953** Style 3 Right Angle
- 33-121** SELTZER Dermal Biopsy Hook 4½" (11.4 cm), sharp point
- 33-280** LERNER Skin Hook Forceps 4½" (11.4 cm), for wound repair
- 34-250** Dissecting Tenaculum Hook 6½" (16.5 cm), sharp point

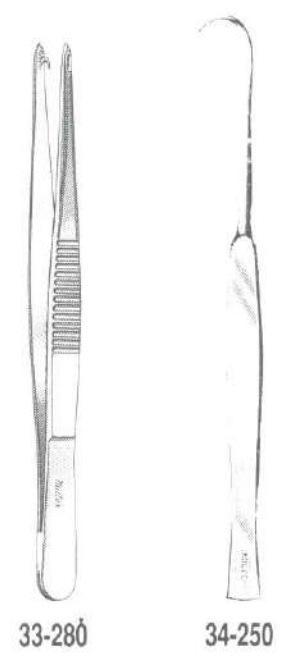



11-20



11-22



11-74
11-76



11-78



11-80
11-81

- 11-20 LAHEY Thyroid Retractor 7 $\frac{3}{4}$ " (19.7 cm)
- 11-22 GREEN Thyroid Retractor 8 $\frac{1}{2}$ " (21.6 cm)
- 11-74 SENN Retractor 6 $\frac{3}{8}$ " (16.2 cm), sharp, double end
- 11-76 SENN Retractor 6 $\frac{3}{8}$ " (16.2 cm), blunt, double end
- 11-78 CRILE Thyroid Retractor 4 $\frac{1}{2}$ " (11.4 cm), double end
3 x 11 mm and 6 x 20 mm blades
- 11-80 MATHIEU Retractor 6 $\frac{1}{2}$ " (16.5 cm), sharp, double end
- 11-81 MATHIEU Retractor 6 $\frac{1}{2}$ " (16.5 cm), blunt, double end
- 11-642-SH BECKMAN-WEITLANER Retractor 9" (22.9 cm),
hinged blades, sharp 3 x 4 teeth
- 11-642-BL BECKMAN-WEITLANER Retractor 9" (22.9 cm),
hinged blades, blunt 3 x 4 teeth

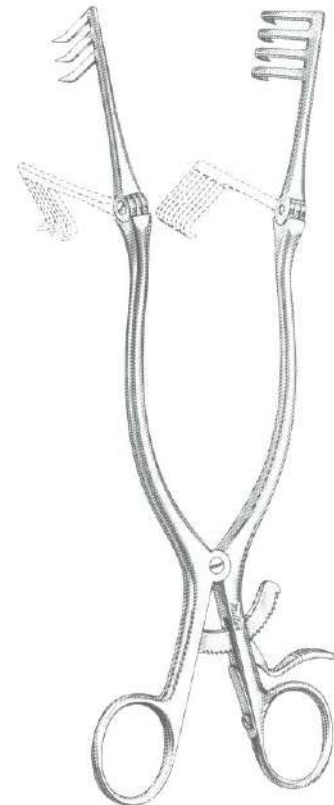

11-642-SH
11-642-BL

Thyroid-Goiter Instruments



11-684



12-80



12-90
12-92

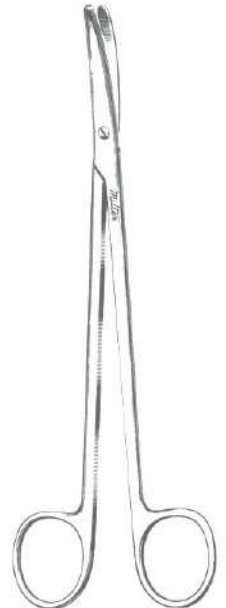

5-179
5-180

11-684 BECKMAN Thyroid Retractor 12½" (31.8 cm), hinged, sharp
4 x 4 teeth ¾" (1.9 cm) x 1" (2.5 cm)

12-80 LAHEY Traction Forceps 6¼" (15.9 cm), 3 x 3 teeth

12-90 LAHEY Ligature Carrier 7½" (19.1 cm), curved left

12-92 LAHEY Ligature Carrier 7½" (19.1 cm), curved right

5-179 LAHEY Goiter Scissors 5½" (14 cm), straight

5-180 LAHEY Goiter Scissors 5½" (14 cm), curved

7-30 PROVIDENCE HOSPITAL Hemostatic Forceps 5½" (14cm), straight

7-32 PROVIDENCE HOSPITAL Hemostatic Forceps 5½" (14cm), curved

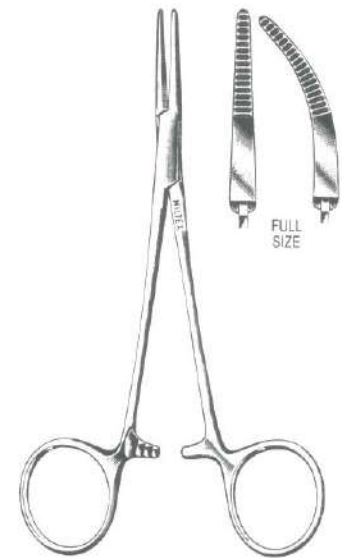

7-30
7-32

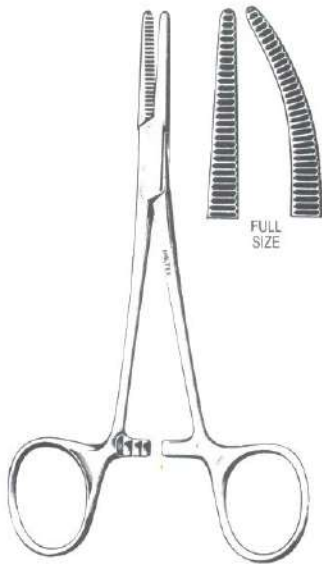

7-60
7-62

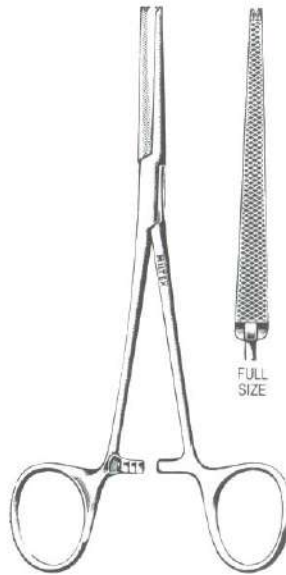

7-98

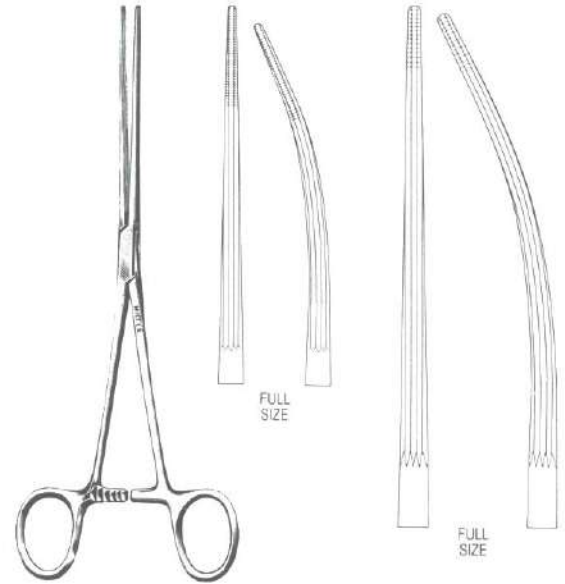

7-230 to 7-236

- 7-60 LAHEY Hemostatic Forceps 5½" (14 cm), straight
- 7-62 LAHEY Hemostatic Forceps 5½" (14 cm), curved
- 7-98 LOVELACE Hemostatic Forceps 6¼" (15.9 cm), straight, cross serrations, 1 x 2 teeth
- 7-230 BAINBRIDGE Hemostatic Forceps 6" (15.2 cm), straight, longitudinal serrations with cross tip serrations
- 7-232 BAINBRIDGE Hemostatic Forceps 6" (15.2 cm), curved, longitudinal serrations with cross tip serrations
- 7-234 BAINBRIDGE Hemostatic Forceps 7¼" (18.4 cm), straight, longitudinal serrations with cross tip serrations
- 7-236 BAINBRIDGE Hemostatic Forceps 7¼" (18.4 cm), curved, longitudinal serrations with cross tip serrations
- 12-170 MASTIN Muscle Clamp 7" (17.8 cm), shanks curved to side, one smooth and one serrated jaw, with four pins

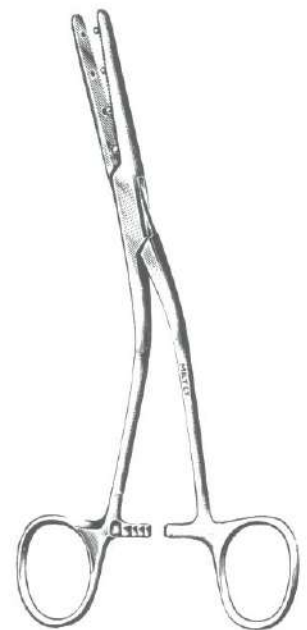

12-170

Trocars and Biopsy Needles



13-2 NESTED TROCAR SET of 4, sizes 6 French (2 mm), 9 French (3 mm), 13 French (4.3 mm) and 17 French (5.7 mm), in flat chrome plated handle. Trocar points and cannula are stainless.

PATTERSON TROCARS 8½" (21.6 cm). Trocar points, Cannula and handle are stainless

13-8	size 1	6 mm dia.
13-9	size 2	7.5 mm dia.
13-10	size 3	10.5 mm dia.
13-11	size 4	12 mm dia.

13-20 DUKE Trocar and Cannula 4½" (11.4 cm), with perforated tube, 5⅞" (13 cm) long, size 17 French (5.7 mm), all stainless

OCHSNER TROCARS, Original Model 6" (15.2 cm), with tubing connection

13-40	12 French (4 mm)	13-46	20 French (6.7 mm)
13-42	14 French (4.7 mm)	13-48	22 French (7.3 mm)
13-44	17 French (5.7 mm)	13-50	24 French (8 mm)

OCHSNER TROCARS, Improved Philadelphia Pattern, 6¼" (15.9 cm) for introduction of catheters

13-60	12 French (4 mm)	for 8 Fr. (2.7 mm) catheters
13-62	14 French (4.7 mm)	for 10 Fr. (3.3 mm) catheters
13-64	16 French (5.3 mm)	for 12 Fr. (4 mm) catheters
13-66	18 French (6 mm)	for 14 Fr. (4.7 mm) catheters
13-68	20 French (6.7 mm)	for 16 Fr. (5.3 mm) catheters
13-70	22 French (7.3 mm)	for 18 Fr. (6 mm) catheters
13-72	24 French (8 mm)	for 20 Fr. (6.7 mm) catheters
13-74	28 French (9.3 mm)	for 22 Fr. (7.3 mm) catheters

MENGHINI BIOPSY NEEDLES,

Improved Model, with built-in stop plug that never requires replacement

For Liver Biopsy
Child Size – 40 mm long

	inside diameter
13-120	1 mm – 19 gauge
13-122	1.2 mm – 18 gauge
13-124	1.4 mm – 17 gauge
13-126	1.6 mm – 16 gauge

For Liver Biopsy
Adult Size – 70 mm long

	inside diameter
13-128	1 mm – 19 gauge
13-130	1.2 mm – 18 gauge
13-132	1.4 mm – 17 gauge
13-134	1.8 mm – 16 gauge

For Kidney Biopsy
120 mm long

	inside diameter
13-150	1 mm – 19 gauge
13-152	1.2 mm – 18 gauge
13-154	1.4 mm – 17 gauge
13-156	1.8 mm – 16 gauge



14-2



14-4

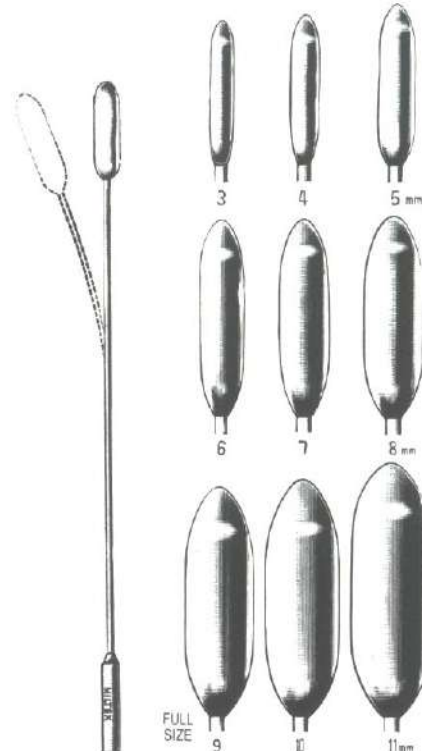

14-8
14-10



14-12

14-2 OCHSNER (FENGER) Gall Duct Probe, cannulated flexible spiral 14" (35 cm) with stylet

14-4-15 MAYO Common Duct Probe 10" (25.4 cm), malleable shaft, 15 French (5 mm)

14-4-18 MAYO Common Duct Probe 10" (25.4 cm), malleable shaft, 18 French (6 mm)

14-8 BAKES Common Duct Dilator Set; fitted plastic case containing 9 dilators sizes 3 to 11 mm, malleable shafts

BAKES COMMON DUCT DILATORS 8¾" (22.2 cm), single sizes, malleable shafts

14-10-3	3 mm dia.	14-10-8	8 mm dia.
14-10-4	4 mm dia.	14-10-9	9 mm dia.
14-10-5	5 mm dia.	14-10-10	10 mm dia.
14-10-6	6 mm dia.	14-10-11	11 mm dia.
14-10-7	7 mm dia.		

14-12 MIXTER Irrigating Dilaprobe 12" (30.5 cm), malleable, with Luer Lock, silver plated



14-22



14-24



14-26



14-27 to 14-29

- 14-22 MAYO Gall Stone Scoop 11" (27.9 cm), double end
- 14-24-17 DESJARDIN Gall Stone Scoop 11" (27.9 cm), malleable shaft, 17 French (5.7 mm)
- 14-24-21 DESJARDIN Gall Stone Scoop 11" (27.9 cm), malleable shaft, 21 French (7 mm)
- 14-24-24 DESJARDIN Gall Stone Scoop 11" (27.9 cm), malleable shaft, 24 French (8 mm)
- 14-24-27 DESJARDIN Gall Stone Scoop 11" (27.9 cm), malleable shaft, 27 French (9 mm)
- 14-26-L FERGUSON Gall Stone Scoop 9½" (24.1 cm), double end, large size scoops ½" (1.3 cm) x 1¼" (3.2 cm) and 7/16" (1.1 cm) x 1" (2.5 cm)
- 14-26-M FERGUSON Gall Stone Scoop 9½" (24.1 cm), double end, medium size scoops ½" (1.3 cm) x 1⅛" (2.8 cm) and 3/8" (.95 cm) x 1" (2.5 cm)
- 14-26-S FERGUSON Gall Stone Scoop 9½" (24.1 cm), double end, small size scoops 3/8" (.95 cm) x 1" (2.5 cm) and 5/16" (.79 cm) x 3/4" (1.9 cm)
- 14-27 MAYO Common Duct Scoop 10½" (26.7 cm), malleable shaft, small size, silver plated
- 14-28 MAYO Common Duct Scoop 10½" (26.7 cm), malleable shaft, medium size, silver plated
- 14-29 MAYO Common Duct Scoop 10½" (26.7 cm), malleable shaft, large size, silver plated



7-200
7-202



14-46

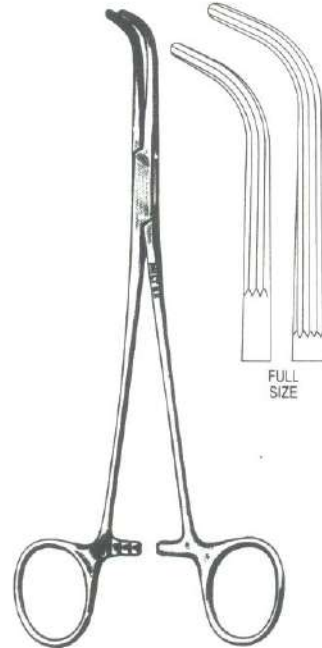

14-48
14-49

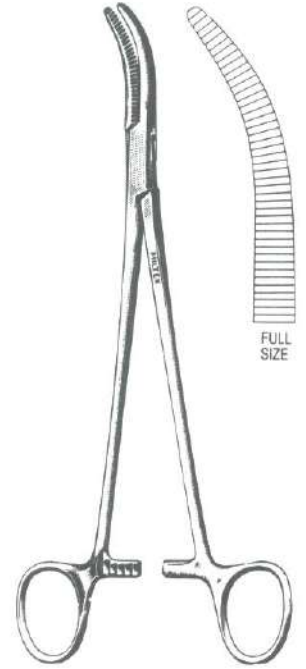

14-50

- 7-200 MIXTER Gall Duct Forceps 6¼" (15.9 cm)
- 7-202 MIXTER Gall Duct Forceps 7¼" (18.4 cm)
- 14-46 LOWER Gall Duct Forceps 7" (17.8 cm)
- 14-48 LAHEY Gall Duct Forceps 7½" (19.1 cm)
- 14-49 LAHEY Gall Duct Forceps 9" (22.9 cm)
- 14-50 MOYNIHAN Gall Duct Forceps 8½" (21.6 cm)
- 14-51 GREEN Cystic Duct Forceps 8½" (21.6 cm), delicate

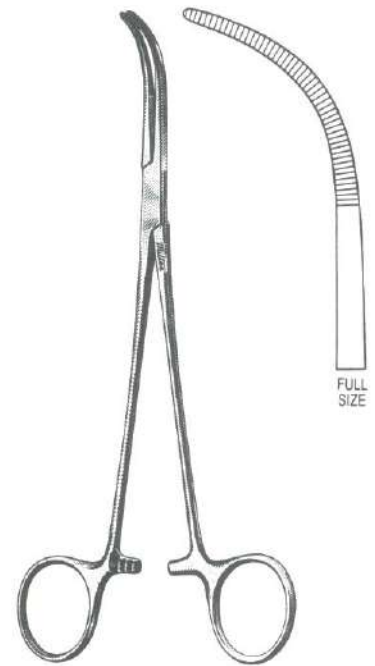

14-51



14-52



7-206

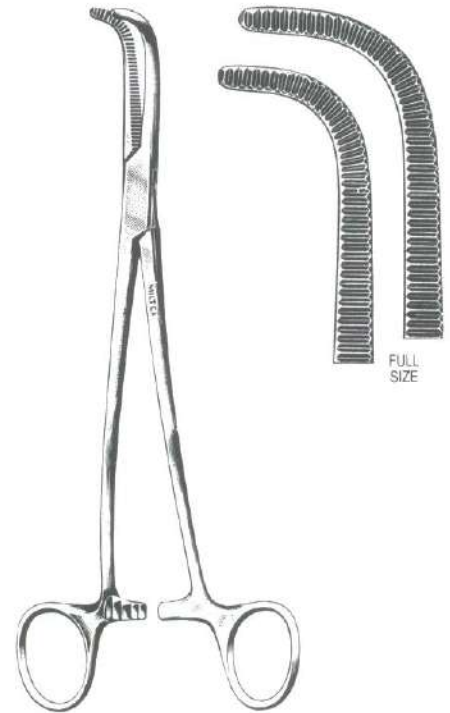

14-56

14-52 JOHNS HOPKINS Gall Bladder Forceps 8" (20.3 cm)

7-206 MIXTER Gall Bladder Forceps 9" (22.9 cm)

14-56 GRAY Cystic Duct Forceps 9" (22.9 cm), serrated, set of two



7-255 to 7-259

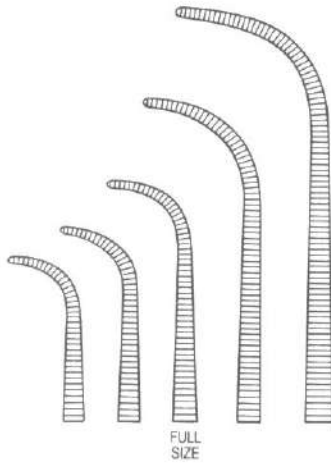

14-62



14-66

- | | |
|-------|--|
| 7-255 | GEMINI-MIXTER Forceps 5½" (14 cm), delicate |
| 7-256 | GEMINI-MIXTER Forceps 7" (17.8 cm), delicate |
| 7-257 | GEMINI-MIXTER Forceps 8" (20.3 cm), delicate |
| 7-258 | GEMINI-MIXTER Forceps 9" (22.9 cm), delicate |
| 7-259 | GEMINI-MIXTER Forceps 11" (27.9 cm), delicate |
| 14-62 | SHALLCROSS Cystic Duct Forceps 7" (17.8 cm) |
| 14-66 | LOVELACE Gall Bladder Forceps 7¼" (18.4 cm), angular,
1" (2.5 cm) wide jaws |



2-50

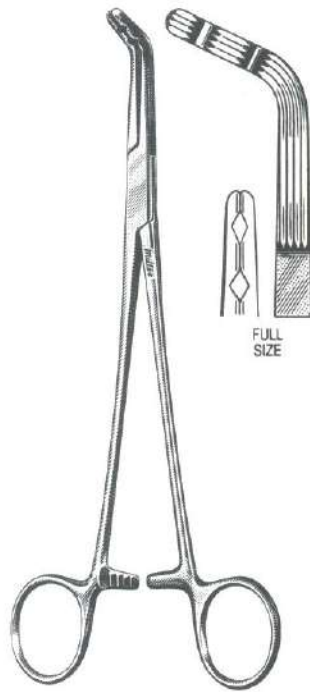

14-69

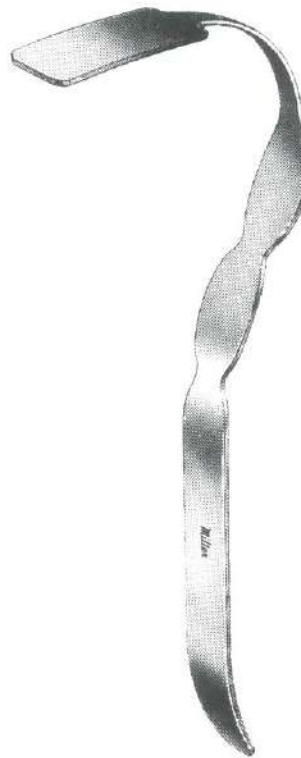

11-192

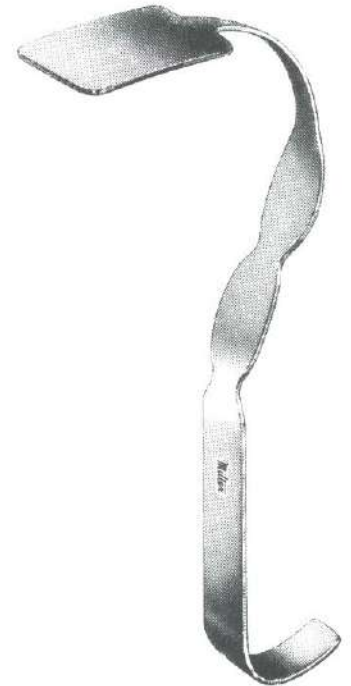

11-194

- 2-50 COLLIN (JUDD-DeMARTEL) Gall Bladder Forceps 6" (15.2 cm)
- 14-69 MALIK Cystic Duct Catheter Clamp for Cholangiography 8½" (21.6 cm), jaws are designed to hold different sizes of catheters.
- 11-192 JUNG Mini-Chole Retractor 10½" (26. cm), 3 cm width blade
- 11-194 JUNG Mini-Chole Retractor 9" (22.9 cm), 4 cm width blade
- 11-196 JUNG Mini-Chole Retractors, set of 2 each of 3 cm width blade and 1 each of 4 cm width blade

For a full line of Retractors see pages 151 - 187



14-84
14-86

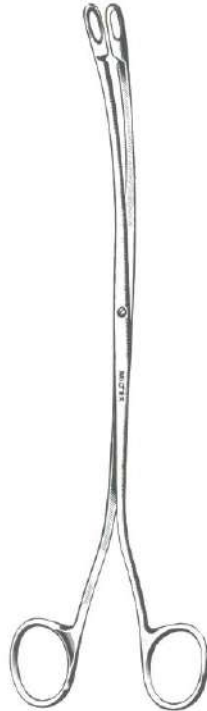

14-88



14-90



5-244
5-245

- 14-84 BLAKE Gall Stone Forceps 8½" (21.6 cm), straight
- 14-86 BLAKE Gall Stone Forceps 8½" (21.6 cm), curved
- 14-88 DESJARDIN (ROCHESTER) Gall Stone Forceps 9" (22.9 cm)
- 14-90 MIXTER Gall Stone Forceps 9" (22.9 cm), length from tip to angle 3" (7.6 cm)
- 5-244 THOREK Gall Bladder Scissors 7¼" (18.4 cm), full curve
- 5-245 THOREK Gall Bladder Scissors 10" (25.4 cm), full curve



16-2



16-3
16-4

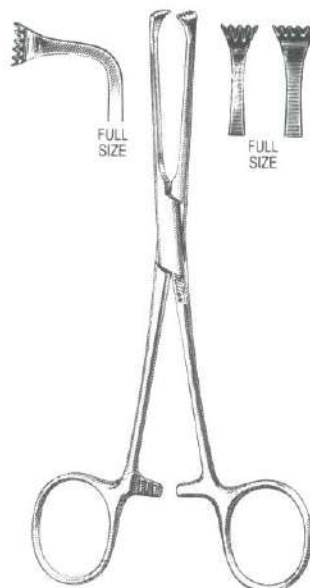

16-6 to 16-24

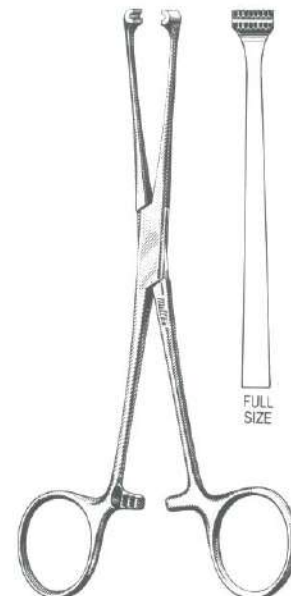

16-25
16-26

- 16-2 LOCKWOOD-ALLIS Tissue Forceps 6¼" (15.9 cm)
- 16-3 Baby ALLIS Tissue Forceps 5" (12.7 cm), 4 x 5 teeth, extra delicate jaws 2.5 mm wide
- 16-4 Baby ALLIS Tissue Forceps 5½" (14 cm), 4 x 5 teeth, delicate jaws 4 mm wide
- 16-6 ALLIS Tissue Forceps 6" (15.2 cm), 4 x 5 teeth
- 16-8 ALLIS Tissue Forceps 6" (15.2 cm), 5 x 6 teeth
- 16-10 ALLIS Tissue Forceps 7¼" (18.4 cm), 5 x 6 teeth
- 16-12 ALLIS Tissue Forceps 10" (25.4 cm), 5 x 6 teeth
- 16-20 ALLIS Tissue Forceps 6" (15.2 cm), 4 x 5 teeth, angular jaws
- 16-22 ALLIS Tissue Forceps 6" (15.2 cm), 5 x 6 teeth, angular jaws
- 16-24 ALLIS Tissue Forceps 7¼" (18.4 cm), 5 x 6 teeth, angular jaws
- 16-25 ALLIS-NC Tissue Forceps 6" (15.2 cm), with double row of non-traumatic teeth
- 16-26 ALLIS-NC Tissue Forceps 7¼" (18.4 cm), with double row of non-traumatic teeth
- 16-30 ALLIS-ADAIR Tissue Forceps 6½" (16.5 cm), 9 x 10 teeth

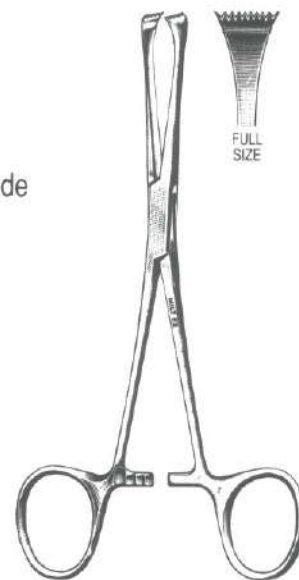

16-30



- 16-31** BOYS-ALLIS Tissue Forceps 6" (15.2 cm), 5 x 6 teeth, heavy pattern
- 16-33** JUDD-ALLIS Tissue Forceps 6" (15.2 cm), 3 x 4 teeth, delicate
- 16-34** JUDD-ALLIS Tissue Forceps 7½" (19.1 cm), 3 x 4 teeth, delicate
- 16-38** THOMS-ALLIS Tissue Forceps 8" (20.3 cm), 6 x 7 teeth
- 16-40** LOCKWOOD Tissue Forceps 7¾" (19.7 cm)
- 16-42** Baby BABCOCK Intestinal Forceps 5½" (14 cm), delicate jaws 6 mm wide
- 16-44** BABCOCK Intestinal Forceps 6¼" (15.9 cm), jaws 9 mm wide
- 16-46** BABCOCK Intestinal Forceps 8¼" (21 cm), jaws 10 mm wide
- 16-48** BABCOCK Intestinal Forceps 9½" (24.1 cm), jaws 15 mm wide

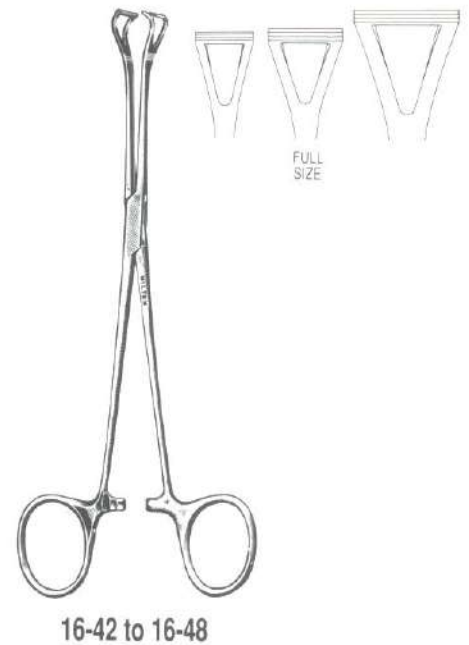



7-106



16-51

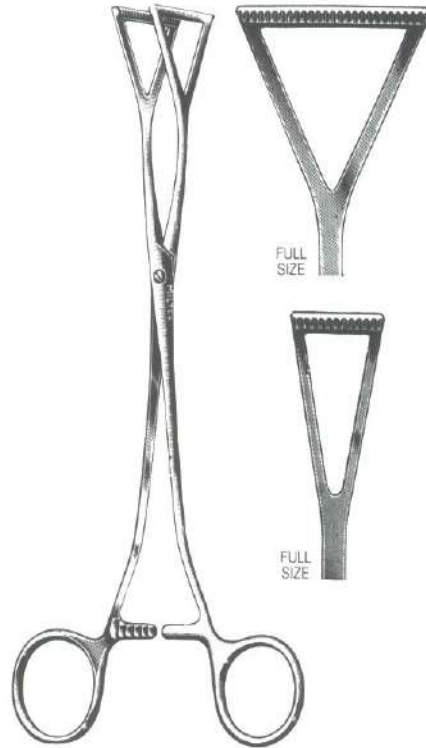

16-52
16-54



16-56

- 7-106 PRATT T-Clamp 6" (15.2 cm)
- 16-51 ADAIR Tissue Holding Tenaculum Forceps 6½" (16.5 cm)
- 16-52 COLLIN Intestinal Forceps 8" (20.3 cm), with ½" (1.3 cm) wide jaws
- 16-54 COLLIN Intestinal Forceps 8" (20.3 cm), with 1" (2.5 cm) wide jaws
- 16-56 WILLIAMS Intestinal Forceps 6½" (16.5 cm), cross serrated jaws
- 16-62 PERCY Intestinal Forceps 6" (15.2 cm), serrated jaws



16-62



6-214

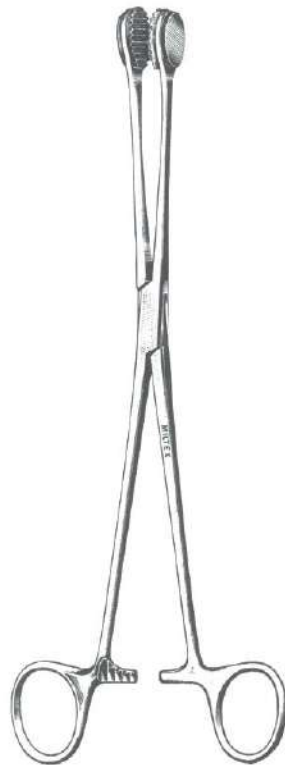

16-70

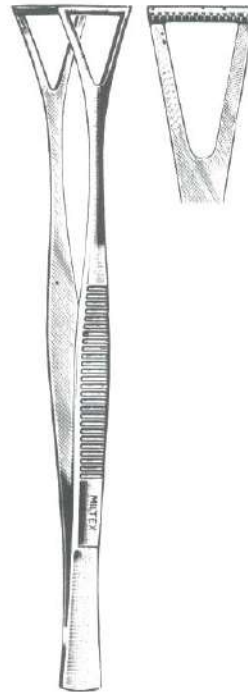

16-72



16-80

- 6-214 SINGLEY Tissue Forceps 9" (22.9 cm), with fenestrated serrated jaws
- 16-70 CHILD Intestinal Forceps 9³/₄" (24.8 cm), with interchangeable rubber jaws
- 2-62 Replacement Rubber Jaws for No. 16-70 forceps
- 16-72 COLLIN-DUVAL Tissue Forceps 8" (20.3 cm), with 1/2" (1.3 cm) wide jaws
- 16-80 WANGENSTEEN Tissue Forceps 9" (22.9 cm), rounded jaws with fine cross serrations
- 7-230 BAINBRIDGE Intestinal Forceps 6" (15.2 cm), straight, longitudinal serrations with cross tip serrations
- 7-232 BAINBRIDGE Intestinal Forceps 6" (15.2 cm), curved, longitudinal serrations with cross tip serrations
- 7-234 BAINBRIDGE Intestinal Forceps 7¹/₄" (18.4 cm), straight, longitudinal serrations with cross tip serrations
- 7-236 BAINBRIDGE Intestinal Forceps 7¹/₄" (18.4 cm), curved, longitudinal serrations with cross tip serrations

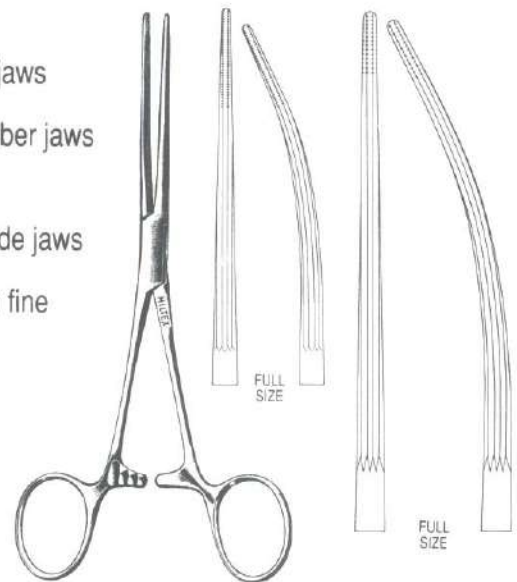

7-230 to 7-236



16-99

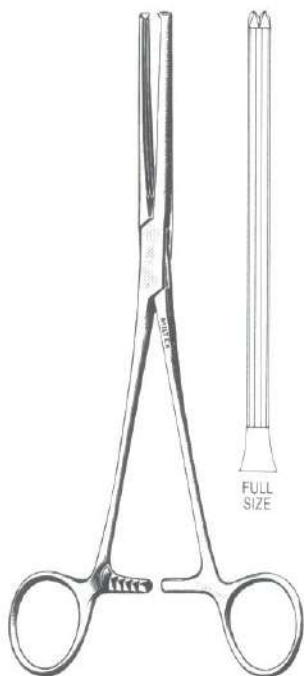

16-100

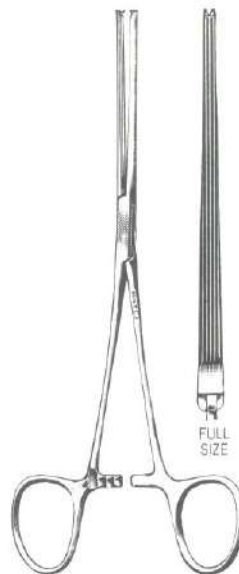

16-102

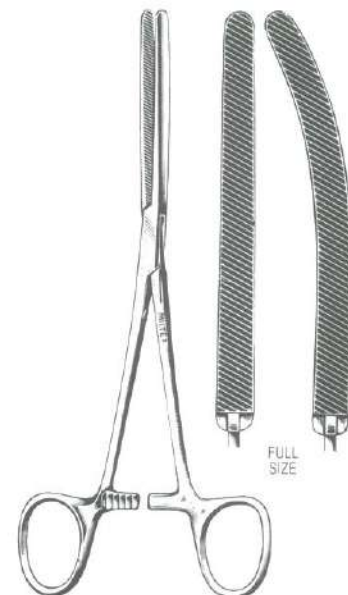

16-108
16-110

- 16-99 DENNIS Anastomosis Clamp 9" (22.9 cm), longitudinal serrations
- 16-100 ALLEN Intestinal Clamp 8" (20.3 cm), longitudinal serrations with 1 x 2 teeth
- 16-102 Baby ALLEN Intestinal Clamp 6½" (16.5 cm), delicate, longitudinal serrations with 1 x 2 teeth
- 16-108 Baby DOYEN Intestinal Forceps 6½" (16.5 cm), straight, flexible blades with diagonal serrations
- 16-110 Baby DOYEN Intestinal Forceps 6½" (16.5 cm), curved, flexible blades with diagonal serrations



16-160
16-162

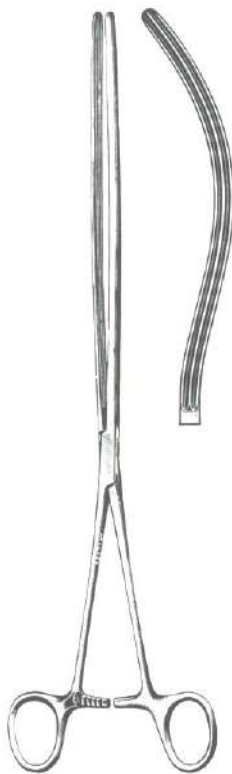

16-120
16-122

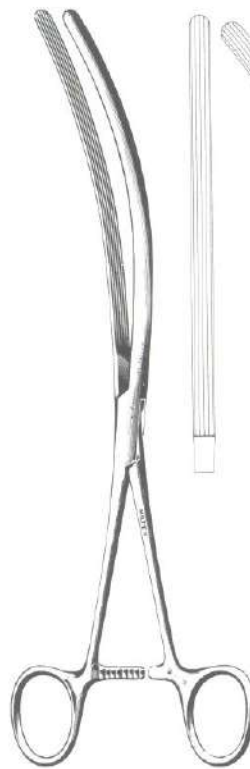

16-130
16-132

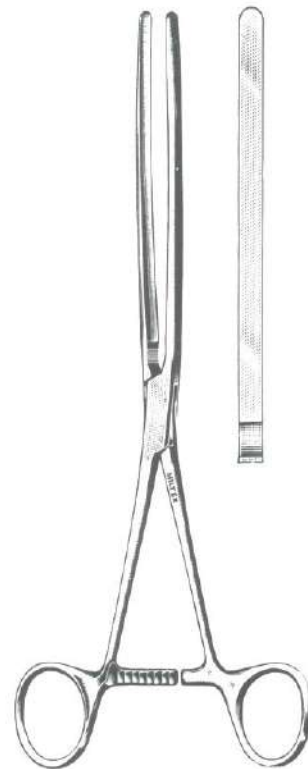

16-140

- 16-160 DOYEN Intestinal Forceps 9" (22.9 cm), straight, flexible blades with longitudinal serrations
- 16-162 DOYEN Intestinal Forceps 9" (22.9 cm), curved, flexible blades with longitudinal serrations
- 16-120 KOCHER Intestinal Forceps 10½" (26.7 cm), straight, longitudinal serrations
- 16-122 KOCHER Intestinal Forceps 10½" (26.7 cm), curved, longitudinal serrations
- 16-130 MAYO-ROBSON Intestinal Forceps 10" (25.4 cm), straight, longitudinal serrations
- 16-132 MAYO-ROBSON Intestinal Forceps 10" (25.4 cm), curved, longitudinal serrations
- 16-140 SCUDDER Intestinal Forceps 9½" (24.1 cm), straight, smooth solid blades
- 30-1805 PEAN Intestinal Forceps 9" (22.9 cm), curved, with longitudinal serrations
- 30-1815 PEAN Intestinal Forceps 10¼" (26 cm), curved, with longitudinal serrations

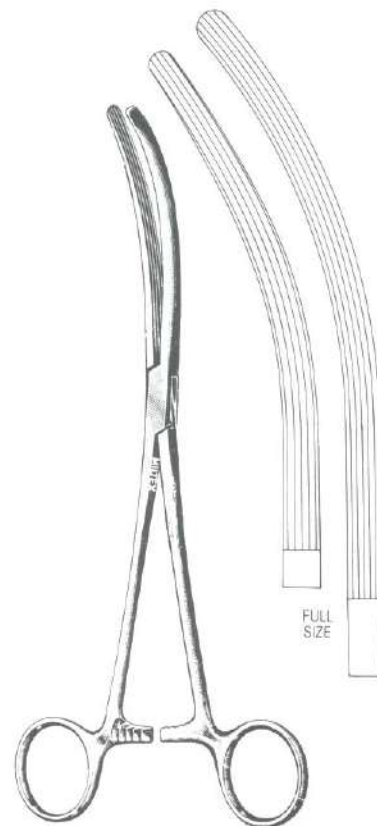

30-1805
30-1815



16-170



16-172



16-174



16-176

- 16-170 FOSS Anterior Resection Clamp 11½" (29.2 cm), S-shape with smooth jaws
- 16-172 BRUNNER Intestinal Forceps 9½" (24.1 cm), longitudinal serrations
- 16-174 FEHLAND Intestinal Clamp 9¾" (24.8 cm), right angle with ¾" (8.3 cm) long jaws
- 16-176 FOSS Intestinal Clamp 11¾" (29.8 cm), right angle with heavy jaws

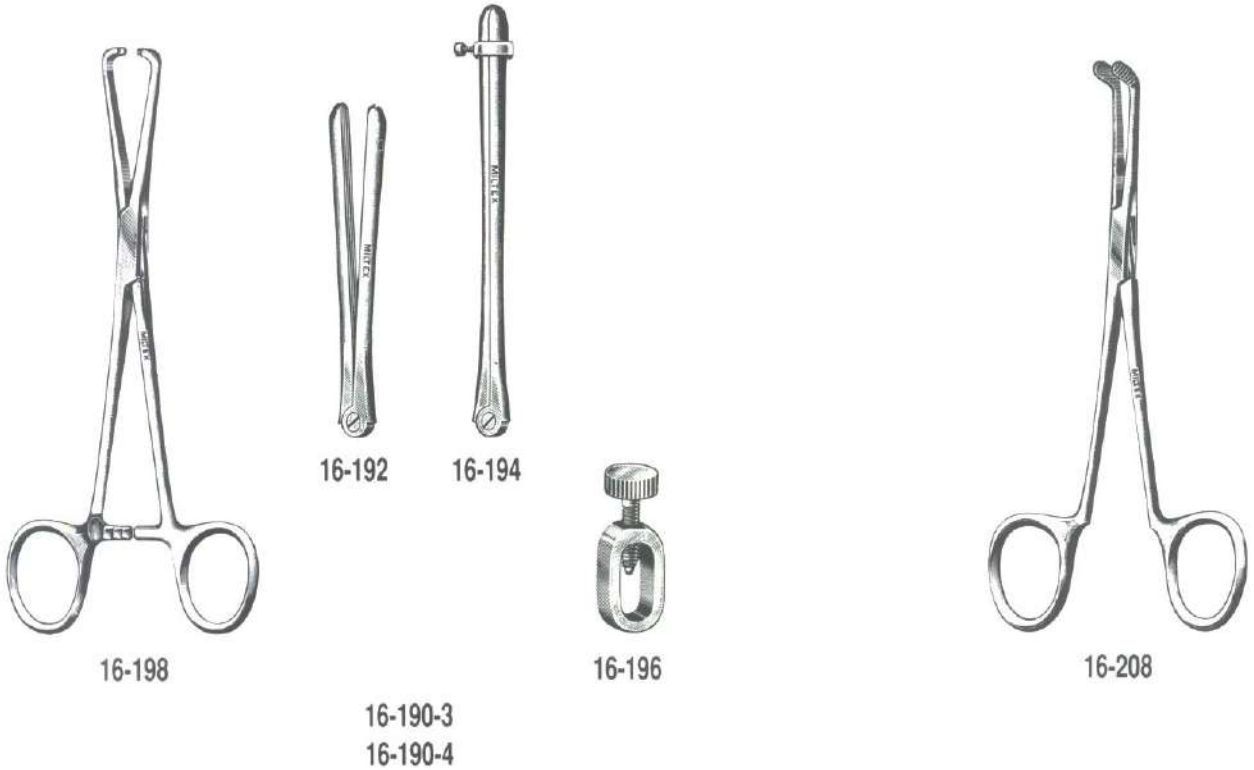

STONE INTESTINAL CLAMPS

- 16-190-3** STONE Clamp Set, including 2 applying forceps and 2 clamps 3" (7.6 cm) with locking devices
- 16-190-4** STONE Clamp Set, including 2 applying forceps and 2 clamps 4" (10.2 cm) with locking devices
- 16-192** STONE Intestinal Clamp 3" (7.6 cm) with locking device
- 16-194** STONE Intestinal Clamp 4" (10.2 cm) with locking device
- 16-196** Locking Device only for STONE Clamps
- 16-198** STONE Clamp Applying Forceps 6¼" (15.9 cm)
- 16-208** BENSON Pylorus Separator 5¾" (14.6 cm)



16-229

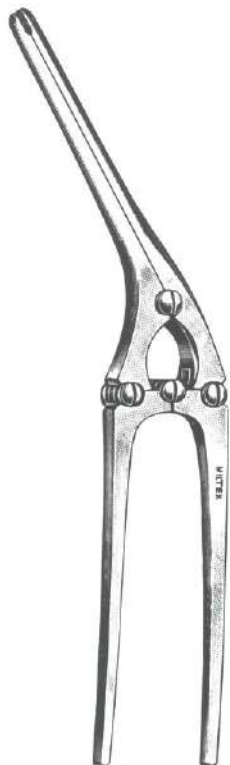

16-230 to 16-234



16-250 to 16-256

- 16-229 Baby PAYR Pylorus Clamp 6" (15.2 cm)
- 16-230 PAYR Pylorus Clamp 8" (20.3 cm)
- 16-232 PAYR Pylorus Clamp 11" (27.9 cm)
- 16-234 PAYR Pylorus Clamp 13¾" (34.9 cm)
- 16-250 BEST Colon Clamp Set of 4, including 1 clamp 7.5 cm, 1 clamp 6 cm and 2 clamps 3.5 cm
- 16-252 BEST Colon Clamp 10½" (26.7 cm), with 3.5 cm jaws
- 16-254 BEST Colon Clamp 10½" (26.7 cm), with 6 cm jaws
- 16-256 BEST Colon Clamp 10½" (26.7 cm), with 7.5 cm jaws



17-100
17-115
17-215



FULL
SIZE
17-100



FULL
SIZE
17-115
17-215



17-500

PENCIL-TYPE MICRO INSTRUMENTS

7¼" (18.4 cm) overall length; extremely delicate working ends

17-100 Forceps, 1 mm wide serrated jaws, straight shaft

17-115 Scissors, 4 mm long blades, straight shaft

17-215 Scissors, 4 mm long blades, angled shaft

17-500 MILTEX Micro Dissecting Scissors 5¾" (14.6 cm), double action, sharp points, spring handle



17-2060
17-2040



17-2150
17-2100

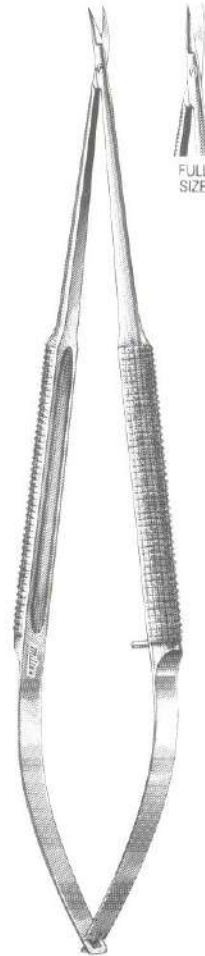

17-2160
17-2110

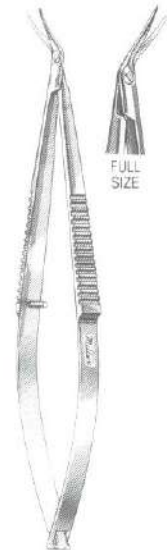

18-1558
18-1559

MILTEK MICRO SURGERY SCISSORS, sharp points

- | | |
|---------|--|
| 17-2060 | 6" (15.2 cm) straight, 8 mm blades, flat handles |
| 17-2040 | 6" (15.2 cm) curved, 8 mm blades, flat handles |
| 17-2150 | 6" (15.2 cm) straight, 6 mm blades, round handles |
| 17-2100 | 6" (15.2 cm) curved, 6 mm blades, round handles |
| 17-2160 | 7½" (18.1 cm) straight, 6 mm blades, round handles |
| 17-2110 | 7½" (18.1 cm) curved, 6 mm blades, round handles |
| 18-1558 | CASTROVIEJO Corneal Scissors 4" (10.2 cm), right, sub-miniature for micro surgery, 6 mm blades |
| 18-1559 | CASTROVIEJO Corneal Scissors 4" (10.2 cm), left, sub-miniature for micro surgery, 6 mm blades |



18-1618
18-1619



18-1625
18-1626



18-1630
18-1631

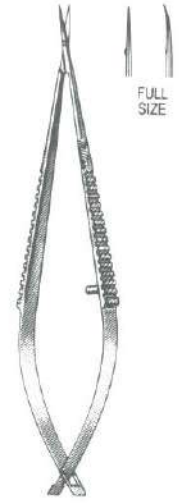

18-1633
18-1634

- 18-1618** Micro Iris Scissors 4" (10.2 cm), straight, sharp points
- 18-1619** Micro Iris Scissors 4" (10.2 cm), curved, sharp points
- 18-1625** McPHERSON-VANNAS Micro Iris Scissors 3/4" (8.3 cm), straight, sharp points
- 18-1626** McPHERSON-VANNAS Micro Iris Scissors 3/4" (8.3 cm), curved, sharp points
- 18-1630** Micro-VANNAS Scissors 3/4" (8.3 cm), straight, ultrafine blades
- 18-1631** Micro-VANNAS Scissors 3/4" (8.3 cm), curved, ultrafine blades
- 18-1633** Micro Scissors 3/4" (8.3 cm), straight, superfine blades
- 18-1634** Micro Scissors 3/4" (8.3 cm), curved, superfine blades
- 19-2150-B** BELLUCCI Micro Ear Scissors 2 3/4" (7 cm) shaft, 4 mm blades, ebony finish

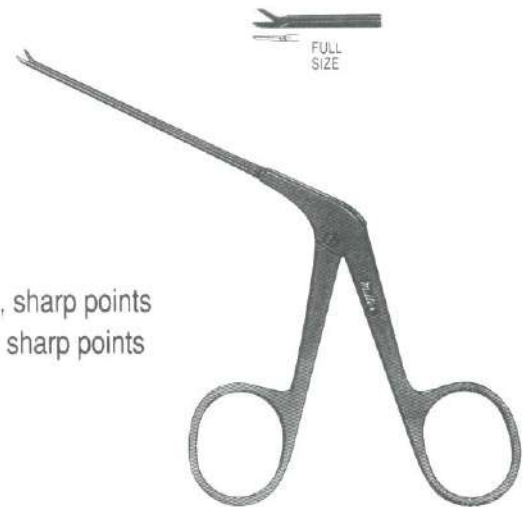

19-2150-B



17-301



17-302



17-303



17-303C



17-303X



17-304

SWISS JEWELER STYLE FORCEPS Non-Magnetic Stainless Steel

- 17-301 Style 1, fine 4 $\frac{3}{4}$ " (12.1 cm)
- 17-302 Style 2, strong, fine, 4 $\frac{3}{4}$ " (12.1 cm)
- 17-303 Style 3, narrow, fine, 4 $\frac{3}{4}$ " (12.1 cm)
- 17-303C Style 3C, narrow, fine, 4 $\frac{3}{8}$ " (11.2 cm)
- 17-303X Style 3, micro-fine, 4 $\frac{3}{4}$ " (12.1 cm)
- 17-304 Style 4, fine, 4 $\frac{3}{8}$ " (11.2 cm)
- 17-305 Style 5, super fine, 4 $\frac{3}{8}$ " (11.2 cm)



17-305



17-305X



17-306



17-307



17-307X

SWISS JEWELER STYLE FORCEPS Non-Magnetic Stainless Steel

- 17-305X Style 5, micro-fine, 4 $\frac{3}{8}$ " (11.2 cm)
- 17-306 Style 6, pickup, 4 $\frac{1}{2}$ " (11.4 cm)
- 17-307 Style 7, fine curved, 4 $\frac{1}{2}$ " (11.4 cm)
- 17-307X Style 7, micro-fine, curved, 4 $\frac{1}{2}$ " (11.4 cm)
- 17-1100 RHOTON Micro Suture Forceps 7" (17.8 cm), straight, with 0.7 mm tying platform
- 17-1150 RHOTON Micro Forceps 7" (17.8 cm), straight, 0.3 mm tips

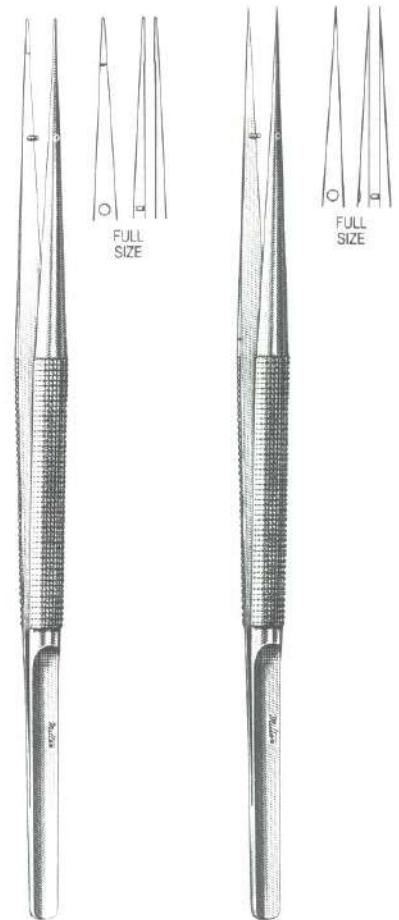

17-1100

17-1150

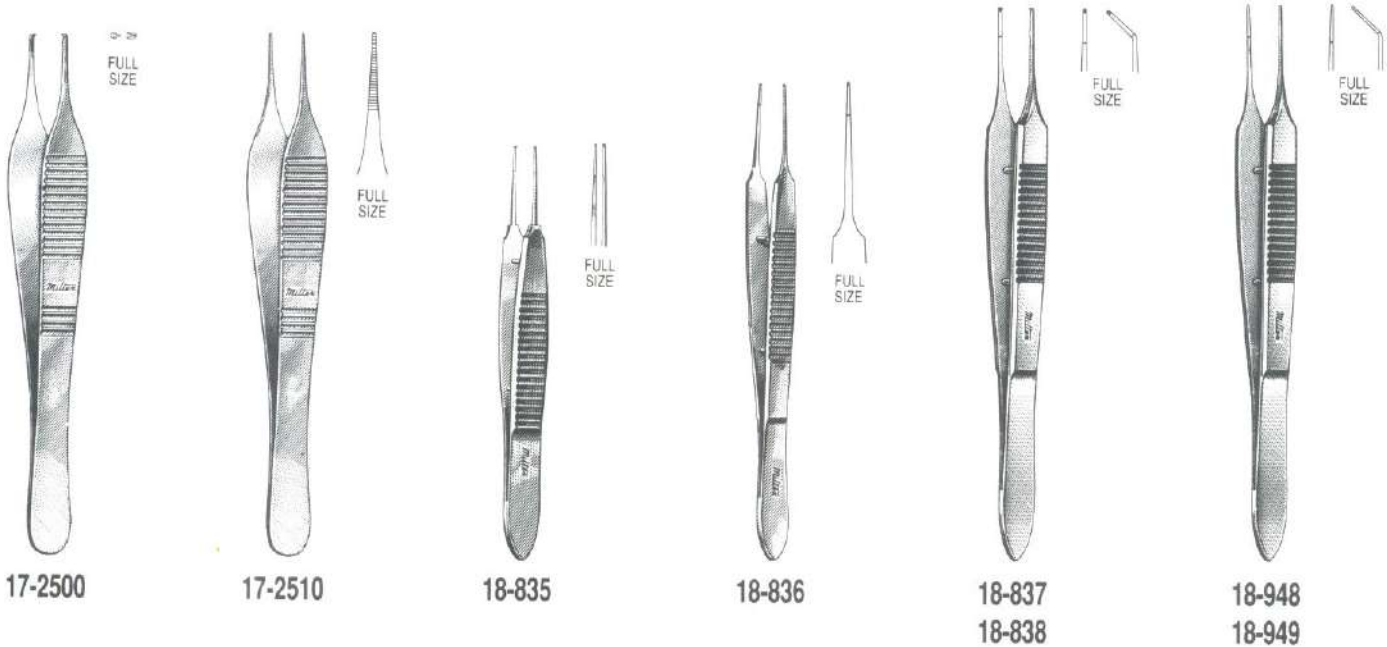

- 17-2500** Micro ADSON Tissue Forceps 4³/₄" (12.1 cm), jaws 0.5 mm wide, 1 x 2 teeth
- 17-2510** Micro ADSON Dressing Forceps 4³/₄" (12.1 cm), serrated jaws 0.5 mm wide
- 18-835** BONN Micro Suturing Forceps 2³/₄" (7 cm), 1 x 2 teeth 0.12 mm, with tying platform
- 18-836** BONN Micro Suturing Forceps 3³/₄" (9.5 cm), 1 x 2 teeth 0.12 mm, with tying platform
- 18-837** McPHERSON Micro Suturing Forceps 3¹/₂" (8.9 cm), straight, 1 x 2 teeth 0.2 mm, with tying platform
- 18-838** McPHERSON Micro Suturing Forceps 3¹/₂" (8.9 cm), angled, 1 x 2 teeth 0.2 mm, with tying platform
- 18-948** McPHERSON Micro Iris Suturing Forceps 3¹/₂" (8.9 cm), straight, smooth platform 0.3 x 5 mm, no teeth
- 18-949** McPHERSON Micro Iris Suturing Forceps 3¹/₂" (8.9 cm), angled, smooth platform 0.3 x 5 mm, no teeth

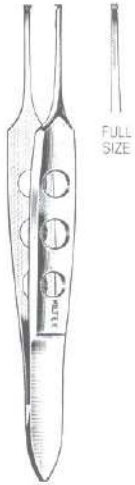

18-867

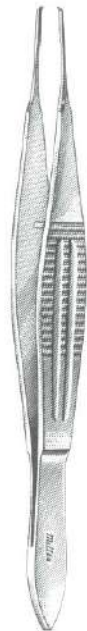

18-953

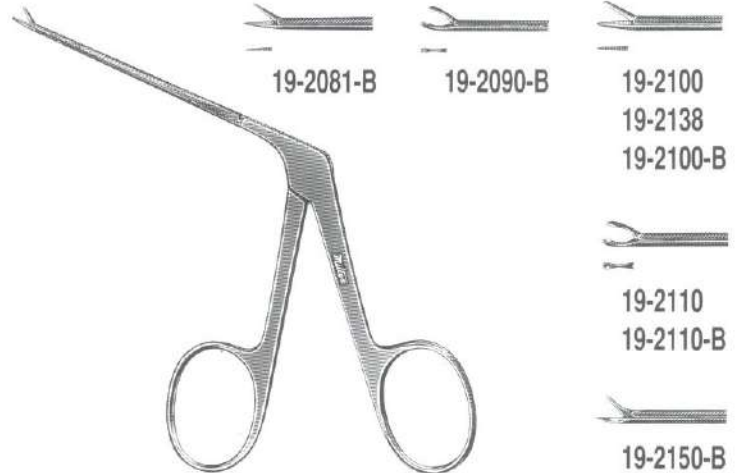

19-2081-B to 19-2150-B

- 18-867 BISHOP-HARMON Micro Tissue Forceps 3 $\frac{3}{8}$ " (8.6 cm), delicate 0.3 mm 1 x 2 teeth
- 18-953 CASTROVIEJO Micro Suturing Forceps 4" (10.2 cm), with 11 mm wide handles, 1 x 2 teeth 0.12 mm, with tying platform
- 19-2081-B Micro Alligator Ear Forceps 3 $\frac{1}{4}$ " (8.3 cm) shaft, serrated jaws 0.6 mm wide, ebony finish
- 19-2100 Micro Alligator Ear Forceps 3 $\frac{1}{4}$ " (8.3 cm) shaft, serrated jaws 0.8 mm wide
- 19-2100-B Micro Alligator Ear Forceps 3 $\frac{1}{4}$ " (8.3 cm) shaft, serrated jaws 0.8 mm wide, ebony finish
- 19-2090-B Micro Alligator Ear Forceps 3 $\frac{1}{4}$ " (8.3 cm) shaft, oval cup jaws 0.5 mm wide, ebony finish
- 19-2110 Micro Alligator Ear Forceps 3 $\frac{1}{4}$ " (8.3 cm) shaft, oval cup jaws 0.8 mm wide
- 19-2110-B Micro Alligator Ear Forceps 3 $\frac{1}{4}$ " (8.3 cm) shaft, oval cup jaws 0.8 mm wide, ebony finish
- 19-2138 HOUSE Micro Strut Forceps 2 $\frac{3}{4}$ " (7 cm) shaft, smooth jaws 0.8 mm wide
- 19-2150-B BELLUCCI Micro Ear Scissors, 2 $\frac{3}{4}$ " (7 cm) shaft, 4 mm blades, ebony finish



17-1000



17-980
17-1010



17-1020

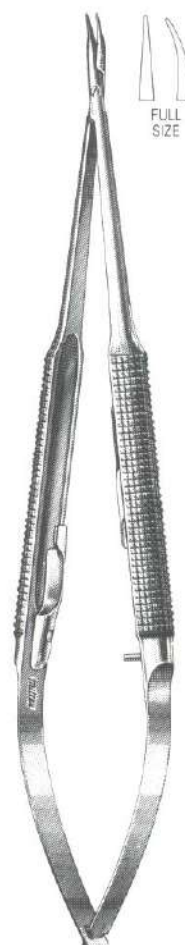

17-1024
17-1025

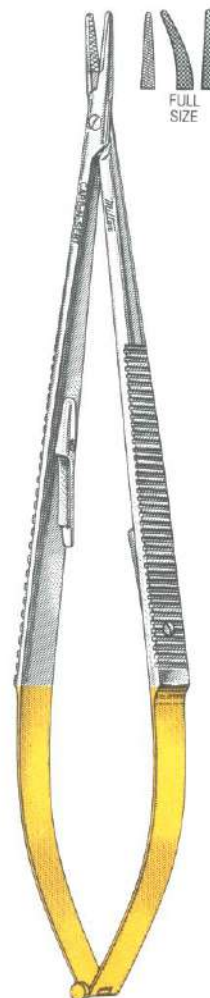

17-1090TC
to 17-1092TC

MILTEK MICRO SURGERY NEEDLE HOLDERS with round handle, 0.6 mm tips

- 17-1000 5¼" (13.3 cm) curved jaws
- 17-980 7⅞" (18.1 cm) straight jaws
- 17-1010 7⅞" (18.1 cm) curved jaws
- 17-1020 5¼" (13.3 cm) curved jaws, with lock
- 17-1024 7⅞" (18.1 cm) straight jaws, with lock
- 17-1025 7⅞" (18.1 cm) curved jaws, with lock

- 17-1090TC JACOBSON Microvascular Needle Holder 7" (17.8 cm), straight, with lock, with CARB-N-SERT jaws
- 17-1091TC JACOBSON Microvascular Needle Holder 7" (17.8 cm), curved, with lock, with CARB-N-SERT jaws
- 17-1092TC JACOBSON Microvascular Needle Holder 8½" (21.6 cm), straight, with lock, with CARB-N-SERT jaws

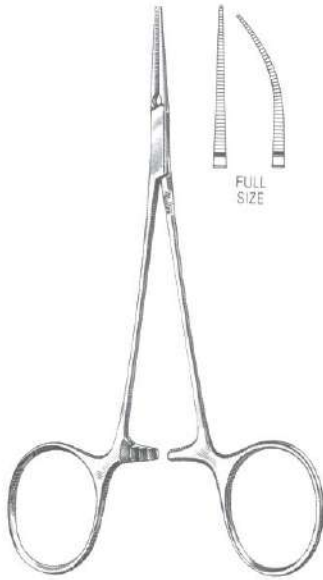

17-2600
17-2602



17-2603



17-4000



17-4005



17-4010



17-4015



17-4050



17-4060



17-4070



FULL
SIZE

17-4030

- 17-2600 JACOBSON Micro Mosquito Forceps 5" (12.7 cm), straight, extremely delicate
- 17-2602 JACOBSON Micro Mosquito Forceps 5" (12.7 cm), curved, extremely delicate
- 17-2603 JACOBSON Hemostatic Forceps 7" (17.8 cm), curved, extremely delicate

MICRO VESSEL CLIPS

- | | | | |
|---------|---------------------------|---------|-------------------------------|
| 17-4000 | straight 0.75 x 4 mm jaws | 17-4050 | slightly curved 1 x 6 mm jaws |
| 17-4005 | straight 0.8 x 6 mm jaws | 17-4060 | fully curved 1 x 6 mm jaws |
| 17-4010 | straight 1 x 8 mm jaws | 17-4070 | 45° angle 1 x 6 mm jaws |
| 17-4015 | straight 1.5 x 10 mm jaws | | |
- 17-4030 Micro Clip Approximator Set, 2 x 6 mm jaws, 15 mm spread
 - 17-4100 Applying Forceps for Micro Clips 5¾" (14.6 cm), with lock
 - 17-4102 Applying Forceps for Micro Clips 5½" (14 cm)



17-4100



17-4102



7-310

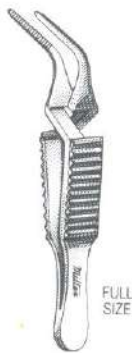

7-315



26-1040



26-1041



26-1042



26-1043

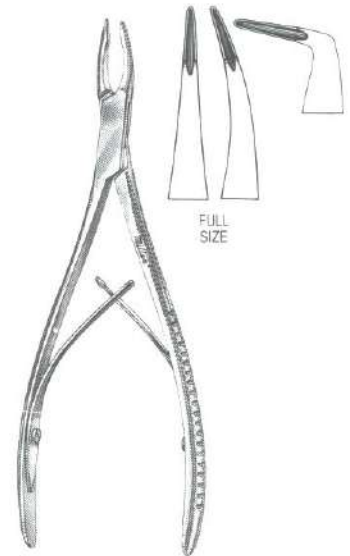

17-4800
17-4801
17D-4802

- 7-310 DIETHRICH Micro Bulldog Clamp 1 $\frac{7}{8}$ " (4.7 cm), straight jaws 8 mm x 1.2 mm
 7-315 DIETHRICH Micro Bulldog Clamp 1 $\frac{3}{4}$ " (4.4 cm), angled jaws 8 mm x 1.2 mm
 26-1040 SCHWARTZ Clip Applying Forceps 8" (20.3 cm)
 26-1041 SCHWARTZ Vessel Clip 1" (2.5 cm), straight, jaws 1.7 x 8 mm
 26-1042 SCHWARTZ Vessel Clip 1" (2.5 cm), slightly angled, jaws 1.7 x 8 mm
 26-1043 SCHWARTZ Vessel Clip 1" (2.5 cm), strong angle, jaws 1.7 x 8 mm
 17-4800 Micro FRIEDMAN Rongeur 5 $\frac{1}{2}$ " (14 cm), straight 1.3 mm wide jaws, very delicate
 17-4801 Micro FRIEDMAN Rongeur 5 $\frac{1}{2}$ " (14 cm), curved 1.3 mm wide jaws, very delicate
 17D-4802 Micro FRIEDMAN Rongeur 5 $\frac{1}{2}$ " (14 cm), 90° angled 1.3 mm wide jaws, very delicate



18-2



18-4



18-10 to 18-14



18-20



18-22
18-24

- 18-2 LANCASTER Eye Speculum 3¼" (8.3 cm), blades 15 x 5 mm
- 18-4 KNAPP Eye Speculum 3¼" (8.3 cm), blades 15 x 6 mm
- 18-10 CASTROVIEJO Eye Speculum 4" (10.2 cm), large blades 18 x 5 mm O.D.
- 18-12 CASTROVIEJO Eye Speculum 3¾" (9.5 cm), medium blades 15 x 5 mm O.D.
- 18-14 CASTROVIEJO Eye Speculum 3¾" (9.5 cm), small blades 13 x 5 mm O.D.
- 18-20 LANGE Eye Speculum 3⅝" (9.2 cm), blades 20 x 5 mm
- 18-22 WILLIAMS Eye Speculum 3¼" (8.3 cm), large blades 15 x 5 mm
- 18-24 WILLIAMS Eye Speculum 2¾" (7 cm), small blades 11 x 5 mm

NOTE: All above instruments are Non-Magnetic



18-30
18-32

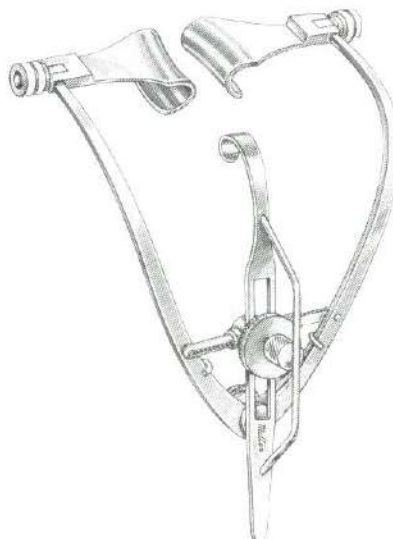

18-33

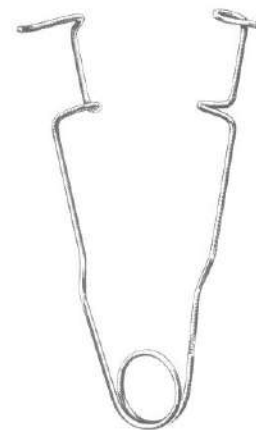

18-34

- 18-30 GUYTON-PARK Eye Speculum 3½" (8.9 cm), solid blades 14 mm wide, with suture posts
- 18-32 GUYTON-PARK Eye Speculum 3½" (8.9 cm), fenestrated blades 14 mm wide, with suture posts
- 18-33 MAUMENEE-PARK Eye Speculum 3½" (8.3 cm), solid blades 14 mm wide, with lock screws
- 18-34 Plain Wire Eye Speculum 2½" (6.4 cm), blades 15 mm wide

NOTE: All above instruments are Non-Magnetic



18-35
18-36



18-46



18-47



18-50

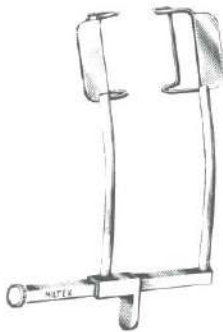

18-54



18-62



18-63
18-64

- 18-35** BARRAQUER Eye Speculum $1\frac{3}{4}$ " (4.4 cm), large blades 15 mm wide
18-36 BARRAQUER Eye Speculum $1\frac{3}{4}$ " (4.4 cm), small blades 10 mm wide
18-46 SMITH Eye Speculum 3" (7.6 cm), blades 15 mm wide, with concealed spring, chrome
18-47 SAUER Eye Speculum $1\frac{1}{4}$ " (3.2 cm), infant size, 10 mm blades
18-50 MURDOCK Eye Speculum $2\frac{1}{4}$ " (5.7 cm), blades 15 mm wide, chrome
18-54 WIENER Eye Speculum $2\frac{1}{4}$ " (5.7 cm), blades 15 mm, with extensions to cover eye lashes, chrome
18-62 MCKINNEY Eye Speculum $2\frac{1}{8}$ " (5.4 cm), blades 15 mm wide, chrome
18-63 COOK Eye Speculum $1\frac{7}{8}$ " (4.7 cm), infant size, 9 mm blades
18-64 COOK Eye Speculum $1\frac{7}{8}$ " (4.7 cm), child size, 11 mm blades

NOTE: All above instruments are Non-Magnetic



18-66



18-68

FULL
SIZE



18-80



18-84



18-88

- 18-66 MELLINGER Eye Speculum 2¾" (7 cm), solid blades 15 mm wide
- 18-68 MELLINGER Eye Speculum 2¾" (7 cm), fenestrated blades 15 mm wide
- 18-80 AGRICOLA Lacrimal Sac Retractor 1½" (3.8 cm), 3 x 3 pointed prongs 4 mm deep
- 18-84 MELLER Lacrimal Sac Retractor 2⅞" (7.3 cm), 3 x 3 prongs 3 mm deep
- 18-88 GOLDSTEIN Lacrimal Sac Retractor 1⅞" (2.8 cm), 3 x 3 pointed prongs 5 mm deep
- 18-96 STEVENSON Lacrimal Sac Retractor 3¼" (8.3 cm), 3 x 3 prongs 3 mm deep



18-96

NOTE: All above instruments are Non-Magnetic



18-100
18-102



11D-27

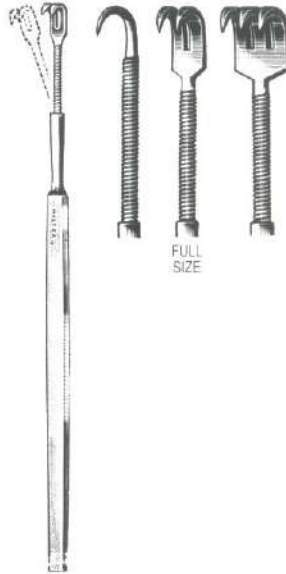

11-30 to 11-34

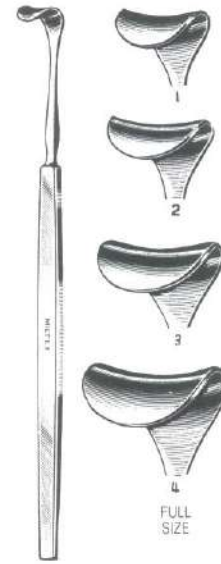

18-110 to 18-116



18-120

- 18-100** KNAPP (ROLLET) Retractor 5¼" (13.3 cm), with 4 sharp prongs
18-102 KNAPP Retractor 5¼" (13.3 cm), with 4 blunt prongs
- 11D-27** KNAPP Lacrimal Sac Retractor 5" (12.7 cm), flexible shaft, 3 sharp prongs
11-30 KNAPP Lacrimal Sac Retractor 6" (15.2 cm), flexible shaft, 1 sharp prong
11-32 KNAPP Lacrimal Sac Retractor 6" (15.2 cm), flexible shaft, 2 sharp prongs
11-34 KNAPP Lacrimal Sac Retractor 6" (15.2 cm), flexible shaft, 3 sharp prongs
- 18-110** DESMARRES Lid Retractor 5½" (14 cm), size 1, 11 mm
18-112 DESMARRES Lid Retractor 5½" (14 cm), size 2, 13 mm
18-114 DESMARRES Lid Retractor 5½" (14 cm), size 3, 15 mm
18-116 DESMARRES Lid Retractor 5½" (14 cm), size 4, 17 mm
- 18-120** JAEGER Lid Plate 4" (10.2 cm), blades 20 mm and 23 mm

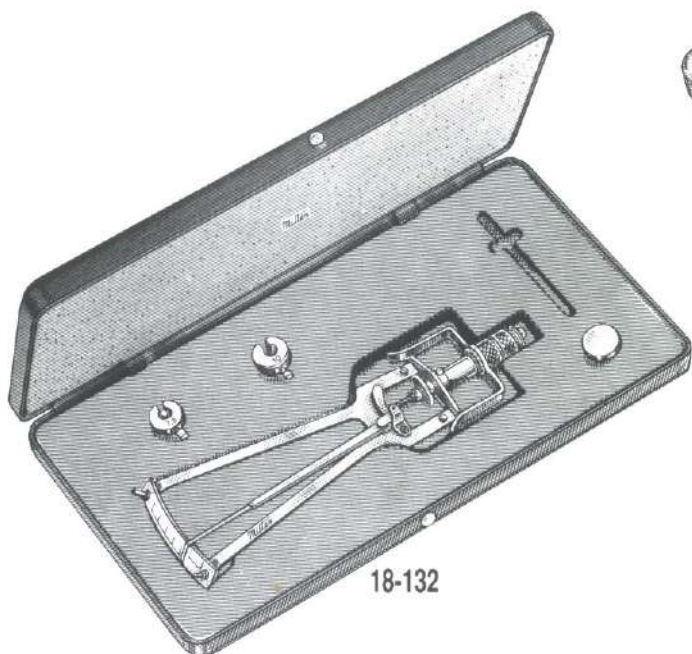

18-132

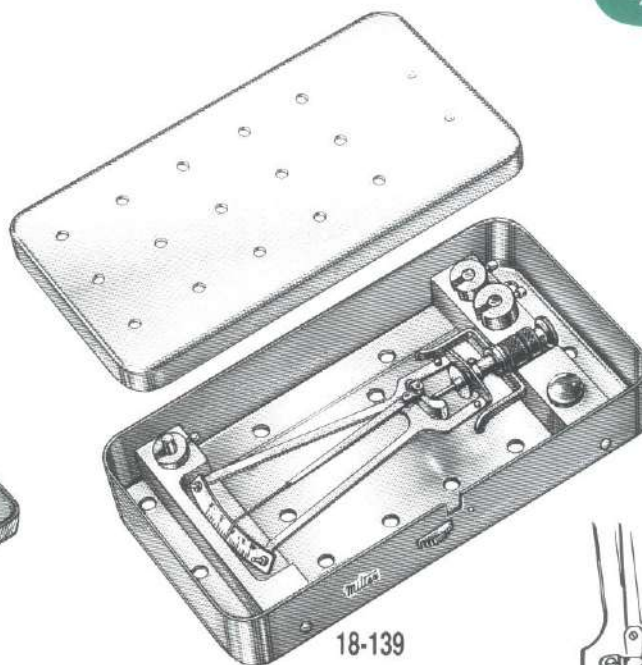

18-139

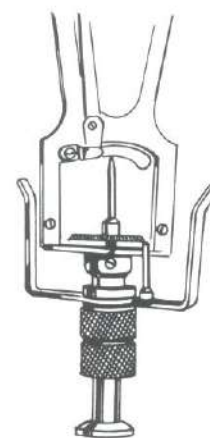

18-132A
18-134A

SCHIOTZ TONOMETERS

All units are constructed with jewelled hammers to minimize friction. Auto-clavable. Scale markings are etched for accuracy. Scales are inclined, permitting reading from above.

Each unit supplied with certification to meet specification established by the Committee on Standardization of Tonometers of the A.A.O.O. Individually packaged in fitted case with weights and test block.

- 18-132** Original Model, with 3 weights (5.5 gr., 7.5 gr. and 10 gr.) Plunger, Footplate and Test Block are stainless steel; remainder made of rustless materials
- 18-132A** Same as No. 18-132, but with Allen Plunger Retractor*
- 18-134** Improved Model, with 4 weights (5.5 gr., 7.5 gr., 10 gr. and 15 gr.), mirror insert on scale reduces error of parallax; entirely made of stainless steel.
- 18-134A** Same as No. 134, but with Allen Plunger Retractor*
- 18-139** Sterilizing Case for Schiottz Tonometers 6½" (16.5 cm) x 3½" (8.9 cm) x 1¼" (3.2 cm) fitted to firmly hold tonometer, weights and test block

*With the Allen Plunger Retractor, the plunger is held in retracted position, flush with the surface of the footplate until tonometer is in place on cornea. This feature will prevent any possible damage to cornea tissue.

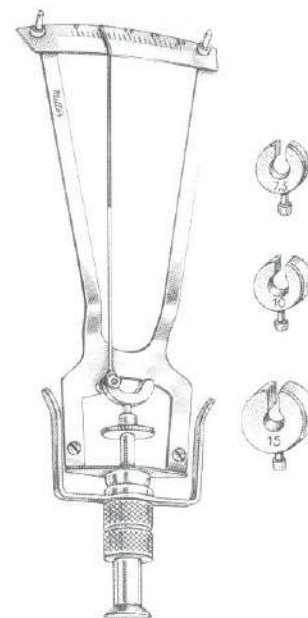

18-134

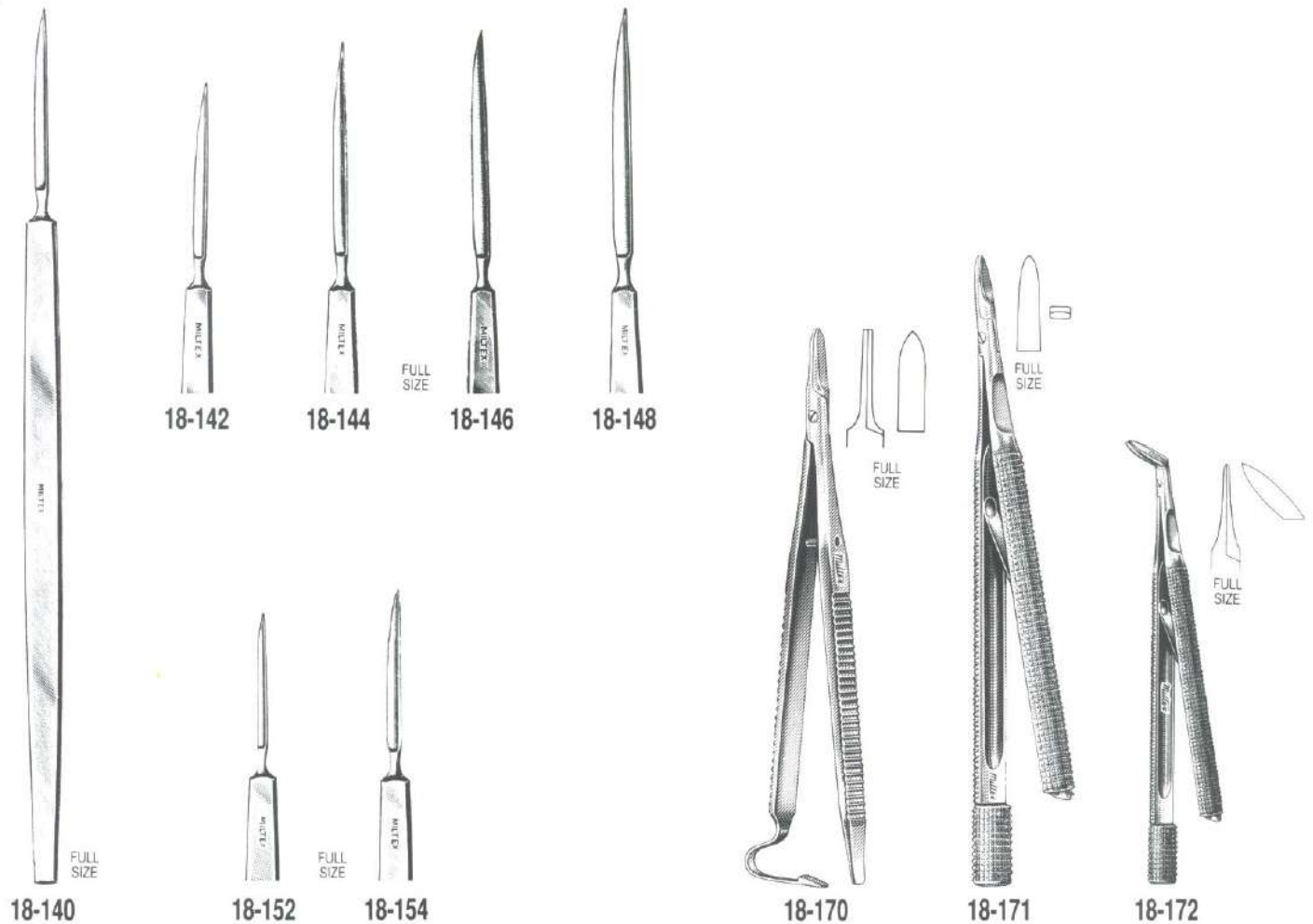

- 18-140** VON GRAEFE Cataract Knife No. 1, 1.5 x 25 mm
- 18-142** VON GRAEFE Cataract Knife No. 2, 1.7 x 27 mm
- 18-144** VON GRAEFE Cataract Knife No. 3, 2 x 30 mm
- 18-146** VON GRAEFE Cataract Knife No. 4, 2.3 x 33 mm
- 18-148** VON GRAEFE Cataract Knife No. 5, 2.5 x 35 mm

- 18-152** WHEELER Discission Knife 1 x 18 mm
- 18-154** KNAPP Cataract Knife 1 x 20 mm

- 18-170** BARRAQUER Blade Breaker and Holder 4½" (11.4 cm), with ratchet lock
- 18-171** CASTROVIEJO Blade Breaker and Holder 5¼" (13.3 cm), with push-pull lock
- 18-172** TROUTMAN-BARRAQUER Mini Blade Breaker and Holder 3¾" (9.5 cm), angled jaws 3 x 10 mm, with push-pull lock

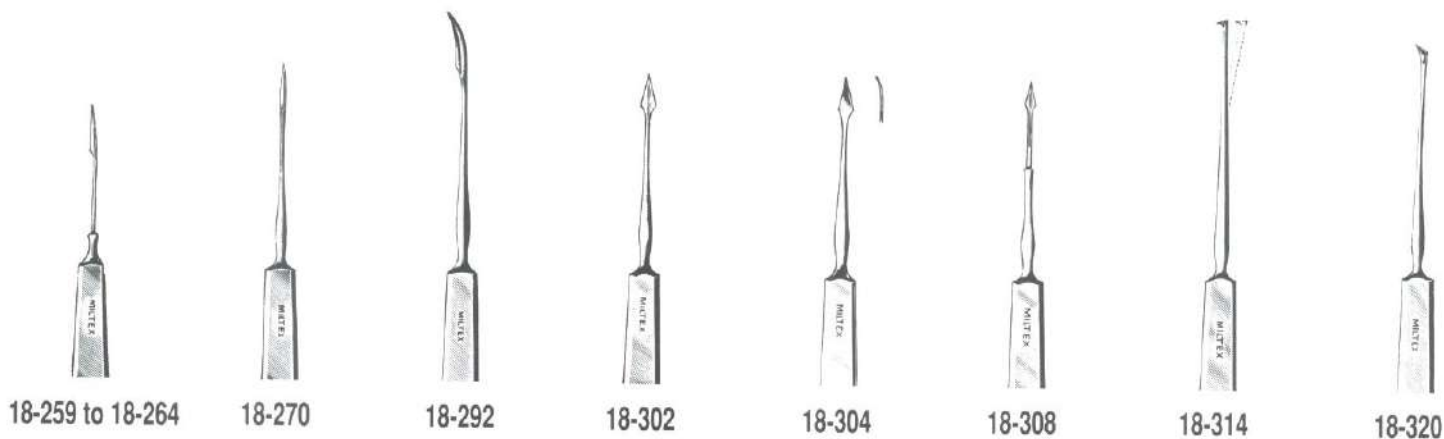

- 18-259** ZIEGLER Knife-Needle 4½" (11.4 cm), size 0, 3 mm blade
- 18-260** ZIEGLER Knife-Needle 4½" (11.4 cm), size 1, 5 mm blade
- 18-262** ZIEGLER Knife-Needle 4½" (11.4 cm), size 2, 6 mm blade
- 18-264** ZIEGLER Knife-Needle 4½" (11.4 cm), size 3, 7 mm blade
- 18-270** KNAPP Knife-Needle 4½" (11.4 cm), 5 mm blade
- 18-292** DEAN Knife-Needle 5" (12.7 cm), curved blade 1 x 7 mm
- 18-302** WALTER Corneal Spud 4⅝" (11.8 cm), straight blade 4 mm
- 18-304** WALTER Corneal Spud 4⅝" (11.8 cm), curved blade 4 mm
- 18-308** BOWMAN Needle with stop 4¾" (12.1 cm), straight blade 3 mm
- 18-314** VON GRAEFE (BECKER) Cystotome 4¾" (12.1 cm), 1 mm blade, right angle, malleable shaft
- 18-320** WILDER Cystotome 5" (12.7 cm), angled blade 3 mm edge
- 18-330** GILL Corneal Knife 4¾" (12.1 cm), slightly curved 3.5 mm wide blade
- 18-331** DESMARRES Corneal Dissector 4¾" (12.1 cm), 3 x 8 mm blade
- 18-344** BARKAN Goniotomy Knife 4½" (11.4 cm), 2.5 mm blade
- 18-350** TOOKE Corneal Knife 4½" (11.4 cm), 2.5 x 15 mm dissecting blade
- 18-370** Foreign Body Needle 5" (12.7 cm), 2 x 5 mm blade



18-330



18-331



18-344



18-350



18-370



18-372



18-374



18-376



18-380



18-384

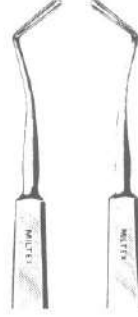

18-388
18-390

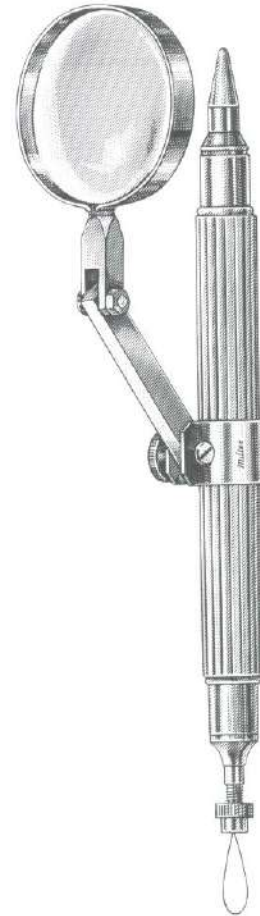

18-398M



18-398

- 18-372 DAVIS Foreign Body Spud 4¾" (12.1 cm), 0.8 mm blade
- 18-374 DIX Foreign Body Spud 4¾" (12.1 cm), 1.7 x 15 mm blade
- 18-376 WALTON Foreign Body Gouge 4½" (11.4 cm), round end
- 18-380 ELLIS Foreign Body Spud 4½" (11.4 cm), 1.2 mm blade, curved
- 18-384 ALVIS Foreign Body Spud 4¾" (12.1 cm), oval curette 1 x 3 mm with fine point
- 18-388 HOSFORD Foreign Body Spud 4¾" (12.1 cm), gouge blade 1 x 7 mm rounded tip, angled to right
- 18-390 HOSFORD Foreign Body Spud 4¾" (12.1 cm), gouge blade 1 x 7 mm rounded tip, angled to left
- 18-398 Eye Magnet and Foreign Body Loop. The magnet probe and the Perlon loop are reversible in the pencil-shape handle. In plastic case.
- 18-398M Eye Magnet and Foreign Body Loop with adjustable Magnifier attached. Reversible plastic handle, metal parts are plated, in plastic case.
- 18-399 MILTEX Eye Magnet; a powerful magnetic cylinder with one round and one pointed interchangeable tip. In velvet lined steel case.

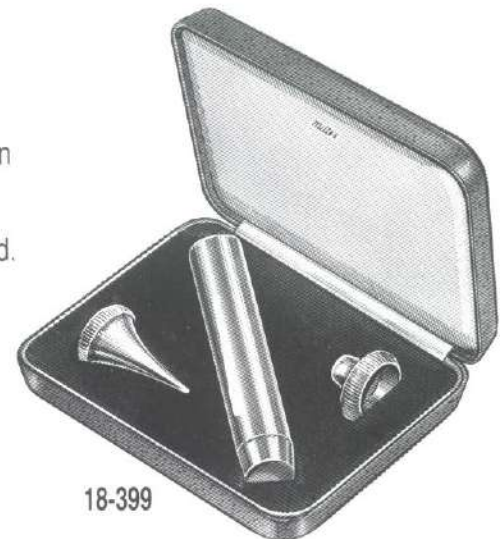

18-399

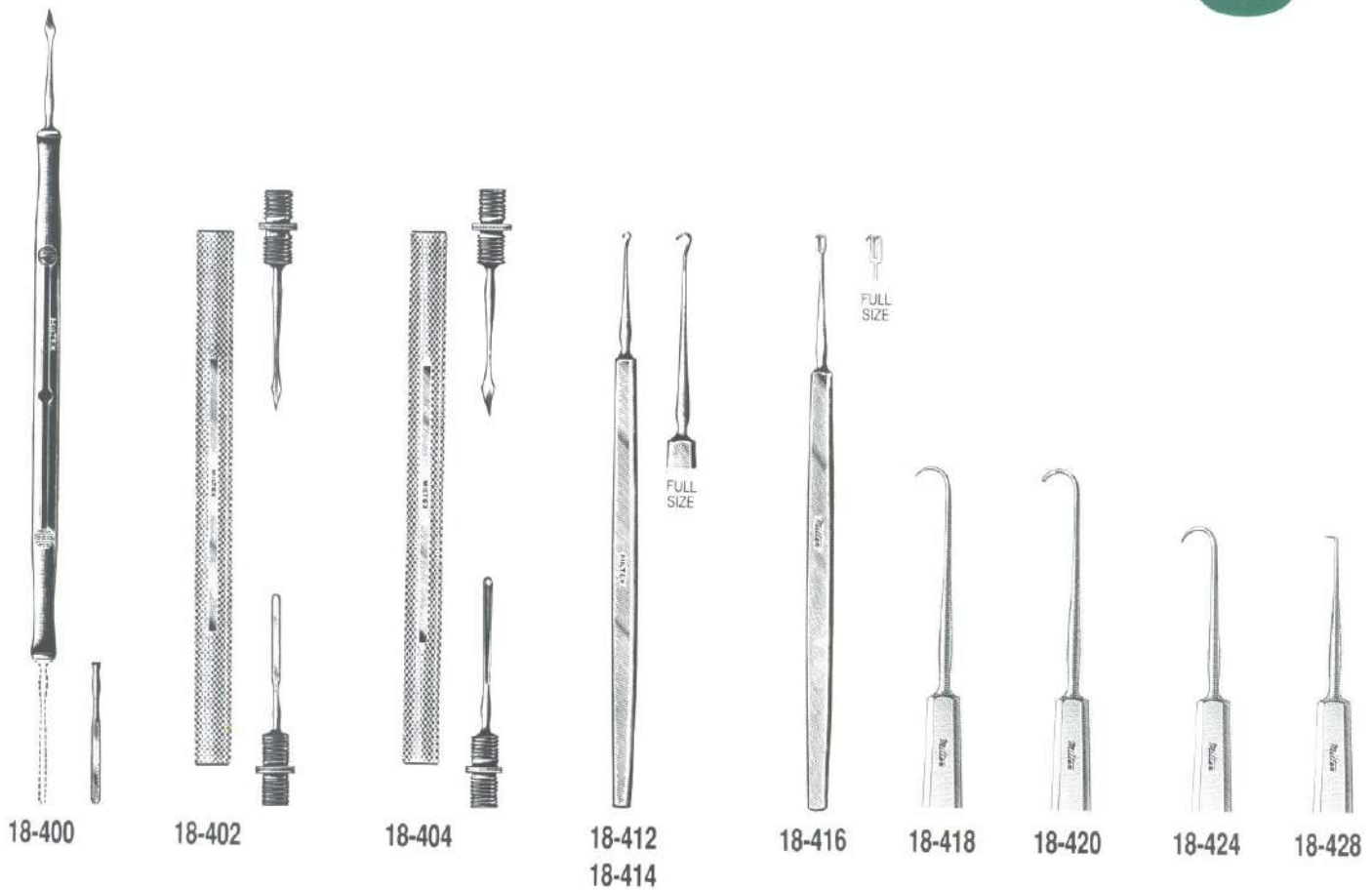

- 18-400** DIX Foreign Body Needle and Spud, protected in sliding handle
- 18-402** DIX Foreign Body Needle and Spud, protected in reversible screw handle
- 18-402A** DIX Foreign Body Needle with screw socket
- 18-402B** DIX Foreign Body Spud with screw socket
- 18-404** DIX Foreign Body Needle and Gouge, protected in reversible screw handle
- 18-412** TYRELL Hook 5" (12.7 cm), sharp
- 18-414** TYRELL Hook 5" (12.7 cm), blunt
- 18-416** GUTHRIE Fixation Hook 5" (12.7 cm), sharp double prongs 1.5 mm wide
- 18-418** WIENER Corneal Hook 5" (12.7 cm), sharp
- 18-420** WIENER Corneal Hook 5" (12.7 cm), blunt
- 18-424** O'CONNOR Hook 4¾" (12.1 cm), sharp
- 18-428** NUGENT Hook 4¾" (12.1 cm), right angle, sharp
- 21-152** MILTEX Hook 4¾" (12.1 cm), sharp prong 2 mm diameter
- 33-121** SELTZER Hook 4½" (11.4 cm), sharp point

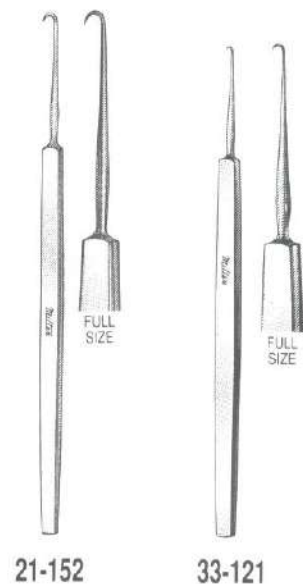



- 18-439 McGANNON Retractor 5" (12.7 cm), fenestrated blade 2.5 mm wide
- 18-440 STEVENS Tenotomy Hook 5" (12.7 cm), right angle 5 mm deep
- 18-442 GREEN Strabismus Hook 5" (12.7 cm), 9 mm deep
- 18-446 JAMESON Strabismus Hook 5" (12.7 cm), 10 mm deep
- 18-450 VON GRAEFE Strabismus Hook 5½" (14 cm), small size 8 mm long
- 18-452 VON GRAEFE Strabismus Hook 5½" (14 cm), medium size 10 mm long
- 18-454 VON GRAEFE Strabismus Hook 5½" (14 cm), large size 11 mm long
- 18-472 DAVIEL Lens Spoon 5" (12.7 cm), 3 mm wide
- 18-480 LEWIS Lens Loop 5¼" (13.3 cm), serrated loop 5.5 x 8 mm
- 18-482 LEWIS Lens Loop 5¼" (13.3 cm), smooth loop 5.5 x 8 mm
- 18-484 WILDER Lens Loop 5¼" (13.3 cm), serrated loop 4 x 15 mm
- 18-486 WILDER Lens Loop 5¼" (13.3 cm), smooth loop 4 x 15 mm



18-498 to 18-506



18-510 18-512 18-514 18-520 18-522 18-524



18-530 to 18-536



18-540 18-542 18-550

- 18-498 MEYHOEFER Chalazion Curette 5" (12.7 cm), size 00, 1 mm
- 18-499 MEYHOEFER Chalazion Curette 5" (12.7 cm), size 0, 1.5 mm
- 18-500 MEYHOEFER Chalazion Curette 5" (12.7 cm), size 1, 1.7 mm
- 18-502 MEYHOEFER Chalazion Curette 5" (12.7 cm), size 2, 2 mm
- 18-504 MEYHOEFER Chalazion Curette 5" (12.7 cm), size 3, 2.5 mm
- 18-506 MEYHOEFER Chalazion Curette 5" (12.7 cm), size 4, 3.5 mm

- 18-510 HEBRA Chalazion Curette 5" (12.7 cm), oval cup 1 x 1.7 mm
- 18-512 HEBRA Chalazion Curette 5" (12.7 cm), oval cup 2 x 3.3 mm
- 18-514 HEBRA Chalazion Curette 5" (12.7 cm), oval cup 2.5 x 4 mm

- 18-520 SKEELE Chalazion Curette 5" (12.7 cm), round cup 1 mm, serated edge
- 18-522 SKEELE Chalazion Curette 5" (12.7 cm), round cup 2 mm, serated edge
- 18-524 SKEELE Chalazion Curette 5" (12.7 cm), round cup 2.5 mm, serated edge

- 18-530 HEATH Chalazion Curette 4" (10.2 cm), size 0, one sharp and one blunt edge, ½ mm
- 18-532 HEATH Chalazion Curette 4" (10.2 cm), size 1, one sharp and one blunt edge, 1 mm)
- 18-534 HEATH Chalazion Curette 4" (10.2 cm), size 2, one sharp and one blunt edge, 2 mm
- 18-536 HEATH Chalazion Curette 4" (10.2 cm), size 3, one sharp and one blunt edge, 3 mm

- 18-540 BUNGE Evisceration Spoon 5½" (14 cm), small size 8 mm cup
- 18-542 BUNGE Evisceration Spoon 5½" (14 cm), large size 11 mm cup

- 18-550 WELLS Enucleation Spoon 6" (15.2 cm), cup 21 mm



18-562



18-564



18-566



18-568



18-570



18-573A
18-574



18-576



18-584

- 18-562 LINDNER Cyclodialysis Spoon and Spatula 5½" (14 cm), malleable spatula end is graduated
- 18-564 CASTROVIEJO Spatula 5½" (14 cm), double end 3.5 mm wide angled and 2 mm wide slightly curved, sterling
- 18-566 SMITH-FISHER Iris Spatula 5" (12.7 cm), one flat end 2 mm wide, one spoon end 2 mm, sterling
- 18-568 FISHER Spoon and Needle 5½" (14 cm), spoon end 7 x 15 mm, needle 33 mm long
- 18-570 GREEN Spatula 6" (15.2 cm), one end 4 x 14 mm, other end 5 x 16 mm
- 18-573A CASTROVIEJO Cyclodialysis Spatula 5¼" (13.3 cm), blades 10 mm and 15 mm x 0.75 mm wide
- 18-574 CASTROVIEJO Cyclodialysis Spatula 5¼" (13.3 cm), blades 10 mm and 15 mm x 0.5 mm wide
- 18-576 CASTROVIEJO Cyclodialysis Spatula 5¼" (13.3 cm), blade 10 x 1 mm
- 18-584 WECKER Iris Spatula 5" (12.7 cm), sterling blade 30 x 2 mm



18-613



18-620
18-624



18-628



18-632

- 18-613 KIRBY Muscle Hook and Expressor 6" (15.2 cm), double end
- 18-620 KIRBY Iris Forceps 4" (10.2 cm), straight, 1 x 2 teeth
- 18-624 KIRBY Iris Forceps 4" (10.2 cm), curved, 1 x 2 teeth
- 18-628 KIRBY Fixation Forceps 4" (10.2 cm), straight 1 x 2 teeth, with slide lock
- 18-632 KIRBY Cornea-Scleral Forceps 4" (10.2 cm), angled tips with 1 x 2 teeth

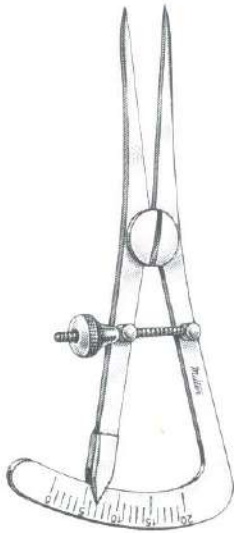

18-650

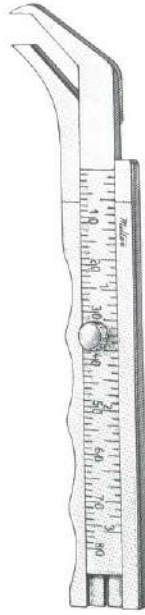

18-657



18-658

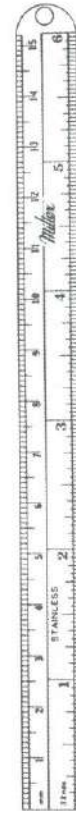

18-660



18-666

- 18-650 CASTROVIEJO Caliper 3¼" (8.3 cm), a combination measuring and marking caliper, graduated 0-20 mm
- 18-657 THORPE Caliper 4½" (11.4 cm), graduated in inches and mm, permits measurements in deep areas
- 18-658 JAMESON Caliper 3¾" (9.5 cm), graduated in inches and mm, with thin tips, chrome
- 18-660 Flexible Stainless Ruler 6" (15.2 cm) x ½" (1.3 cm), graduated in ⅓"(0.8 mm) fractions and mm
- 18-666 WADSWORTH-TODD Cautery 5¾" (14.6 cm), copperhead 9 mm dia. with platinum point

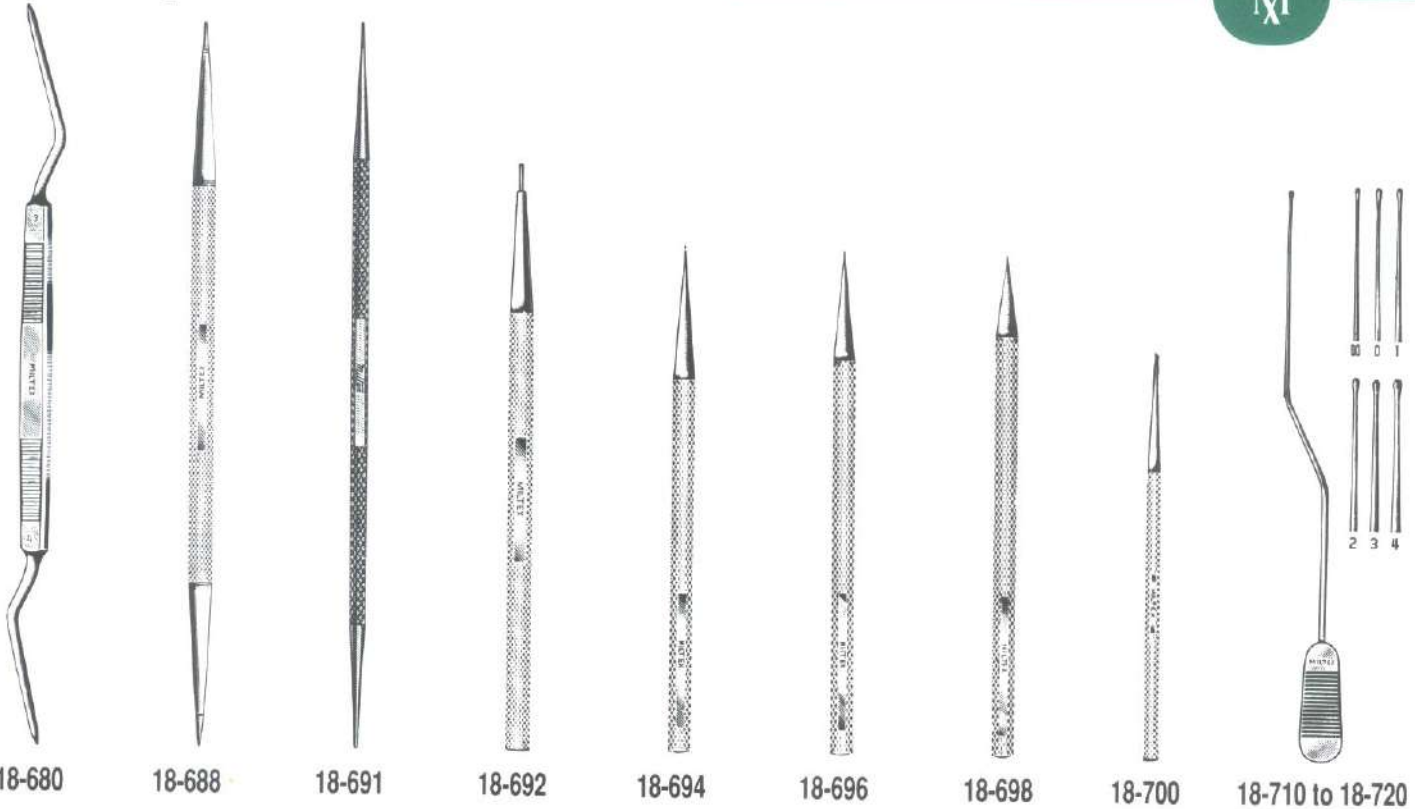

18-680 18-688 18-691 18-692 18-694 18-696 18-698 18-700 18-710 to 18-720



18-722 to 18-732

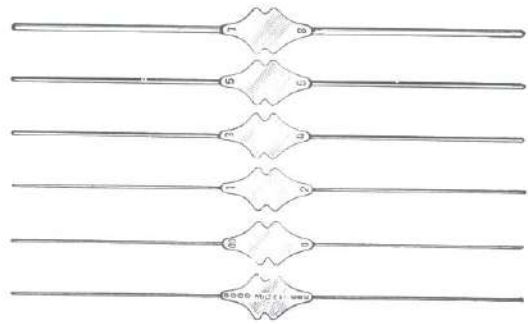

18-740 to 18-750

- 18-680 ZIEGLER Lacrimal Dilator 5½" (14 cm), double end
 - 18-688 HOSFORD Lacrimal Dilator 4¾" (12.1 cm), double end
 - 18-691 CASTROVIEJO Lacrimal Dilator, 5½" (14 cm), one end needle point, other end medium
 - 18-692 MULDOON Lacrimal Dilator 4" (10.2 cm), with 3 mm straight tip to act as guide for tapered dilator
 - 18-694 WILDER Lacrimal Dilator 4" (10.2 cm), fine taper
 - 18-696 WILDER Lacrimal Dilator 4" (10.2 cm), medium taper
 - 18-698 WILDER Lacrimal Dilator 4" (10.2 cm), heavy taper
 - 18-700 RUEDEMANN Infant Lacrimal Dilator 3" (7.6 cm), very delicate, 0.5 mm dia. at tip
- FRENCH PATTERN LACRIMAL PROBES 5" (12.7 cm)
Bayonet shape
- | | | | |
|--------|---------|--------|--------|
| 18-710 | size 00 | 18-716 | size 2 |
| 18-712 | size 0 | 18-718 | size 3 |
| 18-714 | size 1 | 18-720 | size 4 |
-
- WILLIAMS LACRIMAL PROBES 5" (12.7 cm), sterling
- | | | | |
|--------|---------------|--------|----------|
| 18-722 | size 0000-000 | 18-728 | size 3-4 |
| 18-724 | size 00-0 | 18-730 | size 5-6 |
| 18-726 | size 1-2 | 18-732 | size 7-8 |
-
- BOWMAN LACRIMAL PROBES 5" (12.7 cm), sterling
- | | | | |
|--------|---------------|--------|----------|
| 18-740 | size 0000-000 | 18-746 | size 3-4 |
| 18-742 | size 00-0 | 18-748 | size 5-6 |
| 18-744 | size 1-2 | 18-750 | size 7-8 |



FULL
SIZE

18-780



FULL
SIZE

18-782



FULL
SIZE

18-784



FULL
SIZE

18-779



FULL
SIZE

18-781



FULL
SIZE

18-783

EYE DRESSING FORCEPS 4" (10.2 cm), serrated tips

Standard Pattern
0.8 mm wide tips

Extra Delicate Pattern
0.5 mm wide tips

18-780 straight

18-779 straight

18-782 half curved

18-781 half curved

18-784 full curved

18-783 full curved

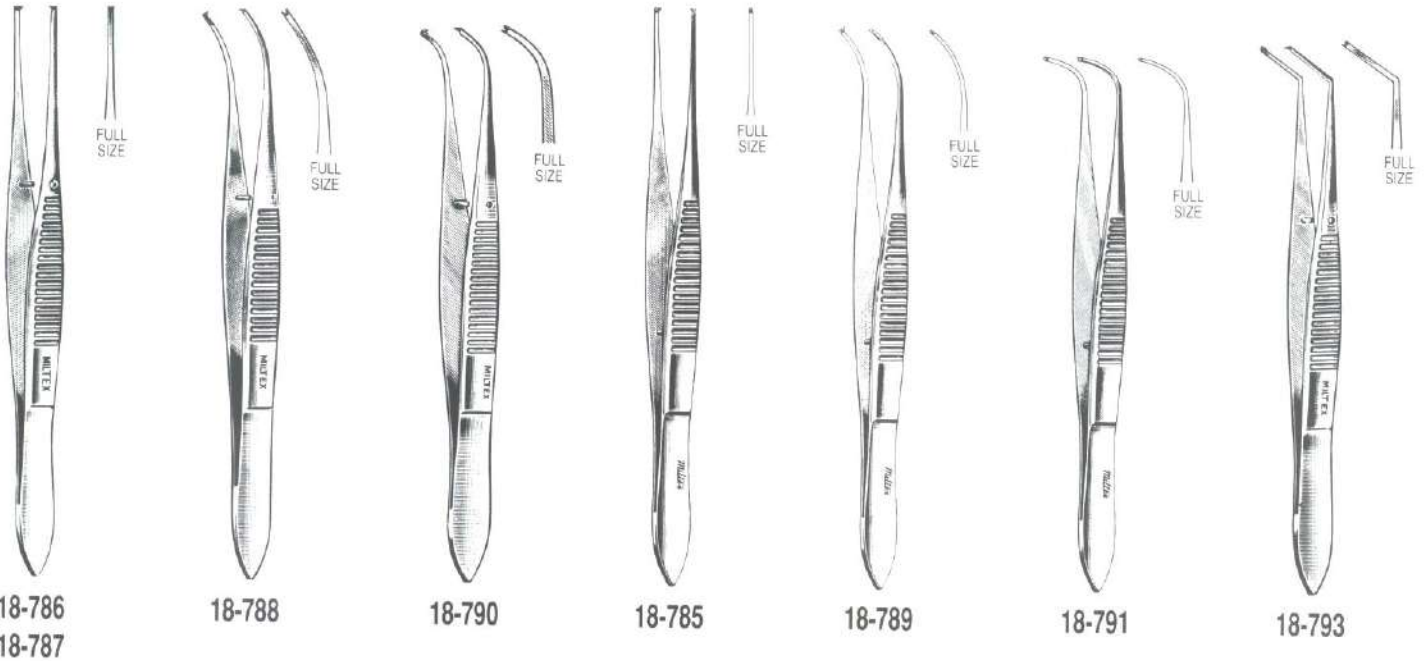

IRIS TISSUE FORCEPS 4" (10.2 cm), 1 x 2 teeth

Standard Pattern
0.8 mm wide tips

Extra Delicate Pattern
0.5 mm wide tips

18-786	straight	18-785	straight
18-787	straight (Non Magnetic)	18-789	half curved
18-788	half curved	18-791	full curved
18-790	full curved		
18-793	O'CONNOR Iris Forceps 3¾" (9.5 cm), angular jaws 0.5 x 9 mm with 1 x 2 teeth		
18-794	BRACKEN Iris Forceps 4" (10.2 cm), with fine cross-serrated tips		



18-794



Ophthalmic Instruments

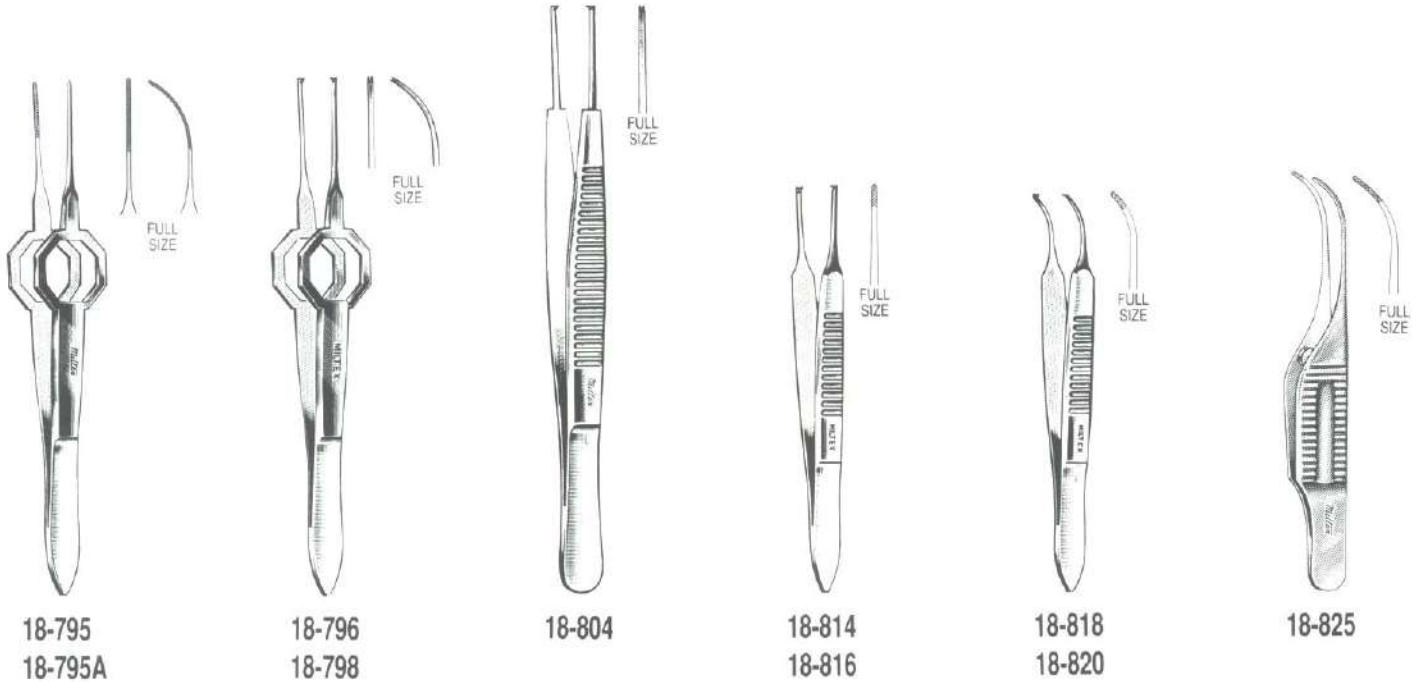

- 18-795 FOERSTER Eye Dressing Forceps 3¾" (9.5 cm), octagonal grip, straight, serrated tips 0.5 mm wide
- 18-795A FOERSTER Eye Dressing Forceps 3¾" (9.5 cm), octagonal grip, full curved, serrated tips 0.5 mm wide
- 18-796 FOERSTER Iris Tissue Forceps 3¾" (9.5 cm), octagonal grip, straight, 1 x 2 teeth, 0.5 mm wide
- 18-798 FOERSTER Iris Tissue Forceps 3¾" (9.5 cm), octagonal grip, full curved, 1 x 2 teeth, 0.5 mm wide
- 18-804 STEVENS Iris Forceps 4" (10.2 cm), straight, 1 x 2 teeth, 1 mm wide
- 18-814 GRAEFE Eye Dressing Forceps 2¾" (7 cm), straight, serrated
- 18-816 GRAEFE Iris Forceps 2¾" (7 cm), straight, 1 x 2 teeth
- 18-818 GRAEFE Eye Dressing Forceps 2¾" (7 cm), curved, serrated
- 18-820 GRAEFE Iris Forceps 2¾" (7 cm), curved, 1 x 2 teeth
- 18-825 GILL (CHANDLER) Iris Forceps 3" (7.6 cm), fine cross serrated tips, 0.6 mm wide
- 18-834 GILL Iris Forceps 2⅞" (7.3 cm), tips 0.6 mm wide, with 1 x 2 teeth
- 18-827 TROUTMAN-BARRAQUER Colibri Type Corneal Utility Forceps 3" (7.6 cm), with 1 x 2 teeth, 0.4 mm, set at 45° angle, with tying platform
- 18-828 TROUTMAN-BARRAQUER Colibri Type Corneal Utility Forceps 3" (7.6 cm), with 1 x 2 teeth, 0.12 mm, set at 45° angle, with tying platform

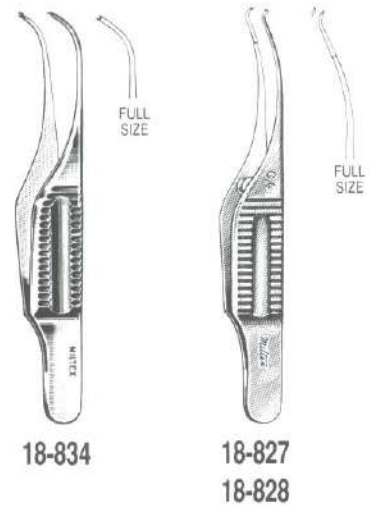

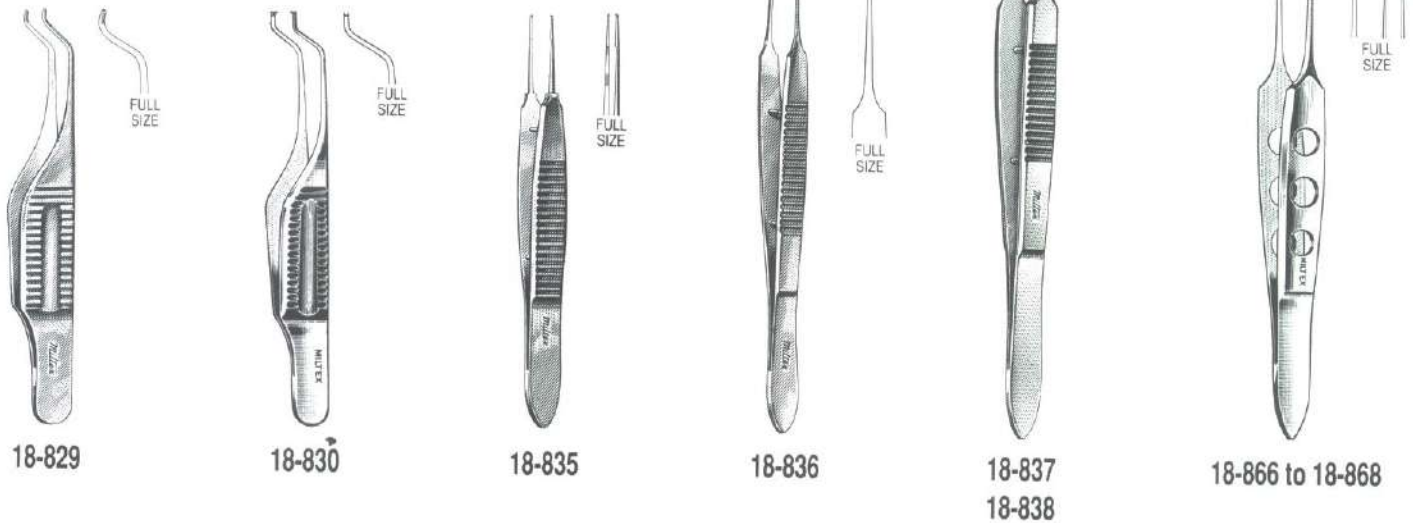

18-829 BOTVIN Iris Forceps 2 $\frac{7}{8}$ " (7.3 cm), fine cross serrated tips, 0.5 mm wide

18-830 GILL HESS Iris Forceps 2 $\frac{3}{4}$ " (7 cm), with 1 x 2 teeth forward 0.5 mm

18-835 BONN Micro Suturing Forceps 2 $\frac{3}{4}$ " (7 cm), 1 x 2 teeth 0.12 mm, with tying platform

18-836 BONN Micro Suturing Forceps 3 $\frac{3}{4}$ " (9.5 cm), 1 x 2 teeth 0.12 mm, with tying platform

18-837 McPHERSON Micro Corneal Suturing Forceps 3 $\frac{1}{2}$ " (8.9 cm), straight, 1 x 2 teeth 0.2 mm, with tying platform

18-838 McPHERSON Micro Corneal Suturing Forceps 3 $\frac{1}{2}$ " (8.9 cm), angled, 1 x 2 teeth 0.2 mm, with tying platform

18-866 BISHOP-HARMON Dressing Forceps 3 $\frac{3}{8}$ " (8.6 cm), fine cross serrated tips 0.5 mm wide

18-867 BISHOP-HARMON Micro Tissue Forceps 3 $\frac{3}{8}$ " (8.6 cm), delicate 0.3 mm 1 x 2 teeth

18-868 BISHOP-HARMON Tissue Forceps 3 $\frac{3}{8}$ " (8.6 cm), standard 0.7 mm 1 x 2 teeth

18-840 Strabismus Forceps 4" (10.2 cm), 1 mm wide tips with 1 x 2 teeth

18-850 GRAEFE Fixation Forceps 4 $\frac{3}{8}$ " (11.2 cm), standard jaws 4.5 mm wide, with fine teeth

18-852 GRAEFE Fixation Forceps 4 $\frac{3}{8}$ " (11.2 cm), standard jaws 4.5 mm wide, with fine teeth, Non-Magnetic

18-854 GRAEFE Fixation Forceps 4 $\frac{3}{8}$ " (11.2 cm), standard jaws 4.5 mm wide, with fine teeth, with catch

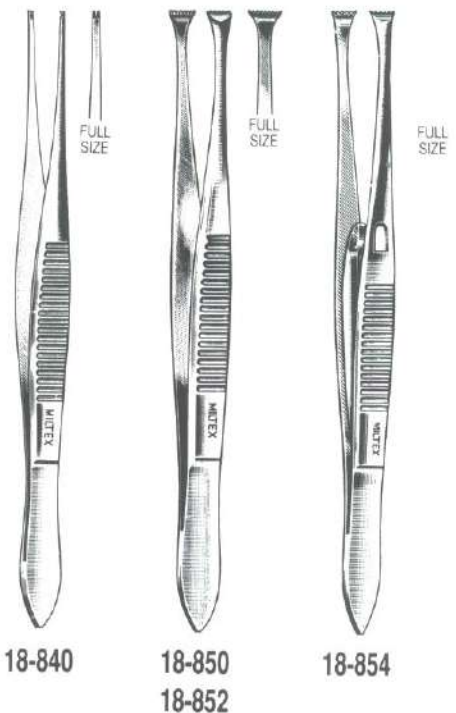

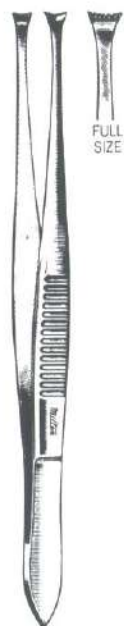

18-860



18-870

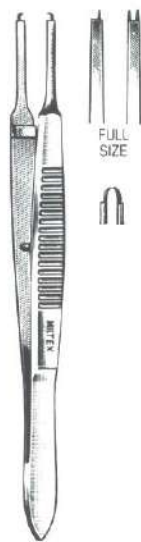

18-876

18-878

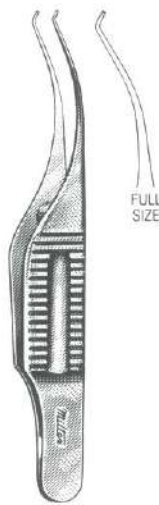

18-880

18-881



18-883

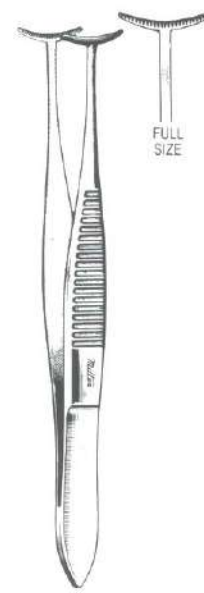

18-896

18-897

- 18-860 WALDEAU Fixation Forceps $4\frac{3}{8}$ " (11.2 cm), concave jaws 5 mm wide, with fine teeth
- 18-870 GUYTON-NOYES Fixation Forceps $4\frac{1}{4}$ " (10.8 cm), with slide catch, curved jaws, 4.5 mm wide, with fine teeth
- 18-876 CASTROVIEJO (ALVIN) Fixation Forceps $3\frac{3}{4}$ " (9.5 cm), straight, 1 x 1 curved teeth extending beyond each other
- 18-878 CASTROVIEJO Fixation Forceps $3\frac{3}{4}$ " (9.5 cm), straight, 2 x 2 curved teeth extending beyond each other
- 18-880 PIERSE Colibri Type Corneal Forceps $3\frac{1}{4}$ " (8.3 cm), tips 0.12 mm
- 18-881 PIERSE Colibri Type Corneal Forceps $3\frac{1}{4}$ " (8.3 cm), tips 0.3 mm
- 18-883 CASTROVIEJO Colibri Type Corneal Forceps 4" (10.2 cm), tips 0.12 mm, with tying platform
- 18-896 GREEN Fixation Forceps 4" (10.2 cm), T-shape, 12 mm wide 19 x 20 teeth
- 18-897 GREEN Fixation Forceps 4" (10.2 cm), T-shape, 5 mm wide 8 x 9 teeth

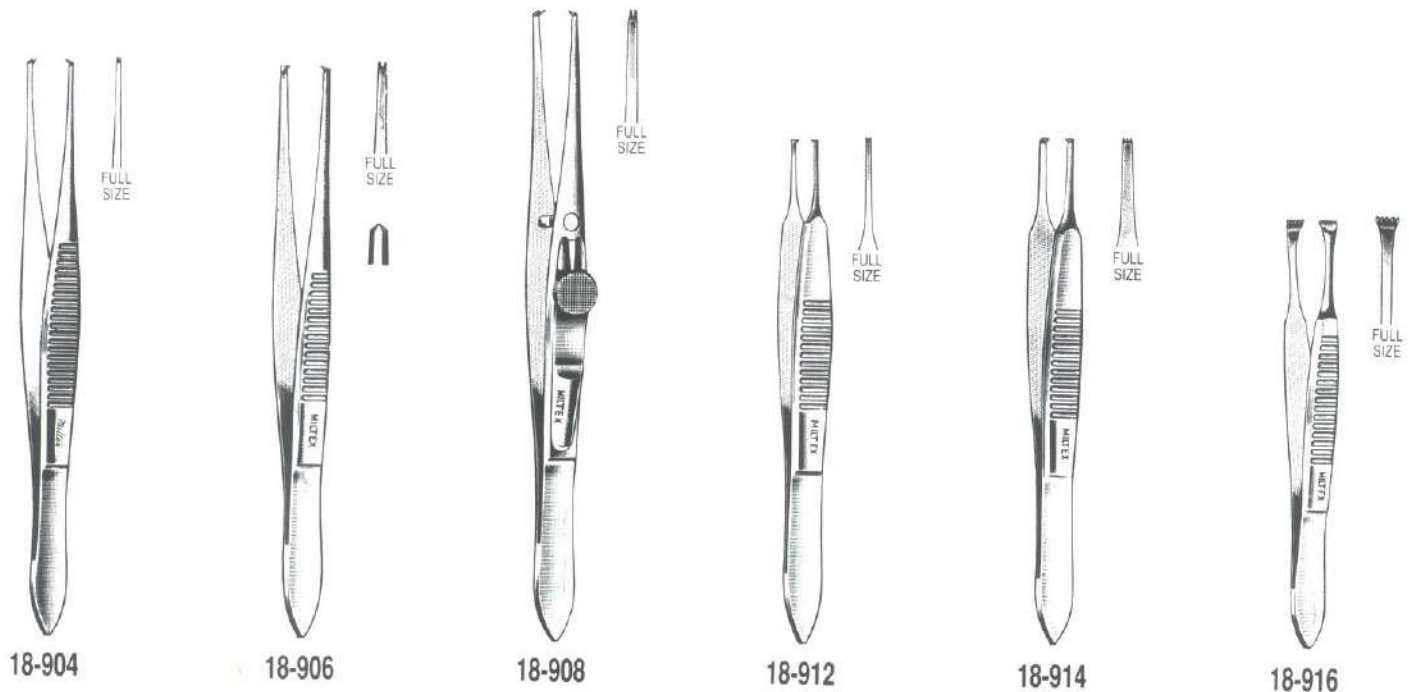

- 18-904** O'BRIEN Fixation Forceps 4" (10.2 cm), delicate 1 x 2 teeth, 0.9 mm wide, angled forward
- 18-906** ELSCHNIG Fixation Forceps 4¼" (10.8 cm), strong 1 x 2 teeth, 0.9 mm wide, angled upwards
- 18-908** ELSCHNIG-O'CONNOR Fixation Forceps 4¼" (10.8 cm), with slide lock, strong 1 x 2 teeth, 1 mm wide, angled upwards
- 18-912** LESTER Fixation Forceps ¾" (9.5 cm), delicate 1 x 2 teeth, 0.6 mm wide
- 18-914** LESTER Fixation Forceps ¾" (9.5 cm), delicate 2 x 3 teeth, 1 mm wide
- 18-916** HARMON Fixation Forceps 3" (7.6 cm), 4 x 5 teeth, delicate 2.5 mm wide jaws

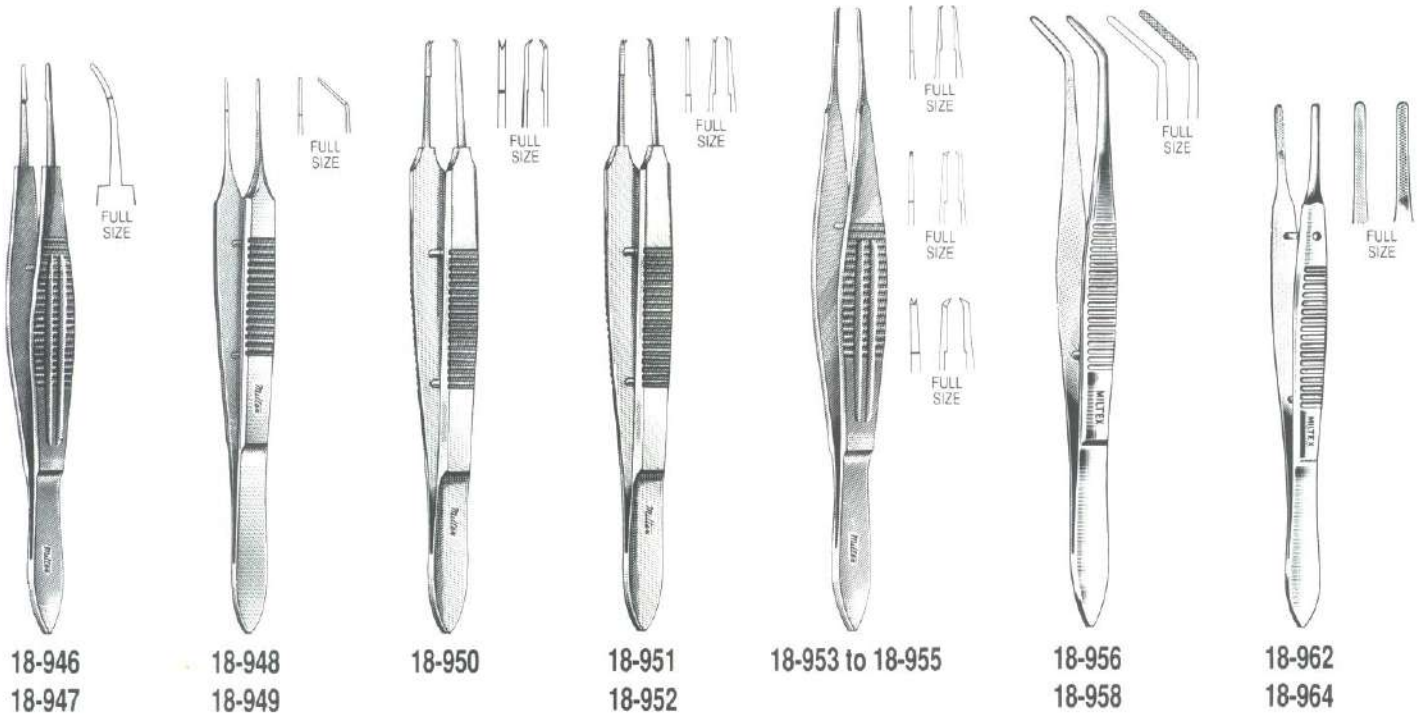

- 18-946** HARMS Suturing Forceps 4 $\frac{1}{8}$ " (10.5 cm), straight, with 11 mm wide handles, tying platform, 0.6 mm wide at tip
- 18-947** HARMS Suturing Forceps 4 $\frac{1}{8}$ " (10.5 cm), curved, with 11 mm wide handles, tying platform, 0.6 mm wide at tip
- 18-948** McPHERSON Micro Iris Suturing Forceps 3 $\frac{1}{2}$ " (8.9 cm), straight, smooth platform 0.3 x 5 mm, no teeth
- 18-949** McPHERSON Micro Iris Suturing Forceps 3 $\frac{1}{2}$ " (8.9 cm), angled, smooth platform 0.3 x 5 mm, no teeth
- 18-950** CASTROVIEJO Suturing Forceps 4" (10.2 cm), 1 x 2 teeth 0.9 mm, with tying platform
- 18-951** CASTROVIEJO Suturing Forceps 4" (10.2 cm), 1 x 2 teeth 0.3 mm, with tying platform
- 18-952** CASTROVIEJO Suturing Forceps 4" (10.2 cm), 1 x 2 teeth 0.6 mm, with tying platform
- 18-953** CASTROVIEJO Micro Suturing Forceps 4" (10.2 cm), with 11 mm wide handles, 1 x 2 teeth 0.12 mm, with tying platform
- 18-954** CASTROVIEJO Suturing Forceps 4" (10.2 cm), with 11 mm wide handles, 1 x 2 teeth 0.6 mm, with tying platform
- 18-955** CASTROVIEJO Suturing Forceps 4" (10.2 cm), with 11 mm wide handles, 1 x 2 teeth 0.9 mm, with tying platform
- 18-956** NUGENT Utility Forceps 4 $\frac{1}{4}$ " (10.8 cm), smooth tips 1.2 mm wide
- 18-958** NUGENT Utility Forceps 4 $\frac{1}{4}$ " (10.8 cm), cross serrated tips 1.2 mm wide
- 18-962** McCULLOUGH Utility Forceps 4" (10.2 cm), smooth tips 1.5 mm wide
- 18-964** McCULLOUGH Utility Forceps 4" (10.2 cm), cross serrated tips 1.5 mm wide

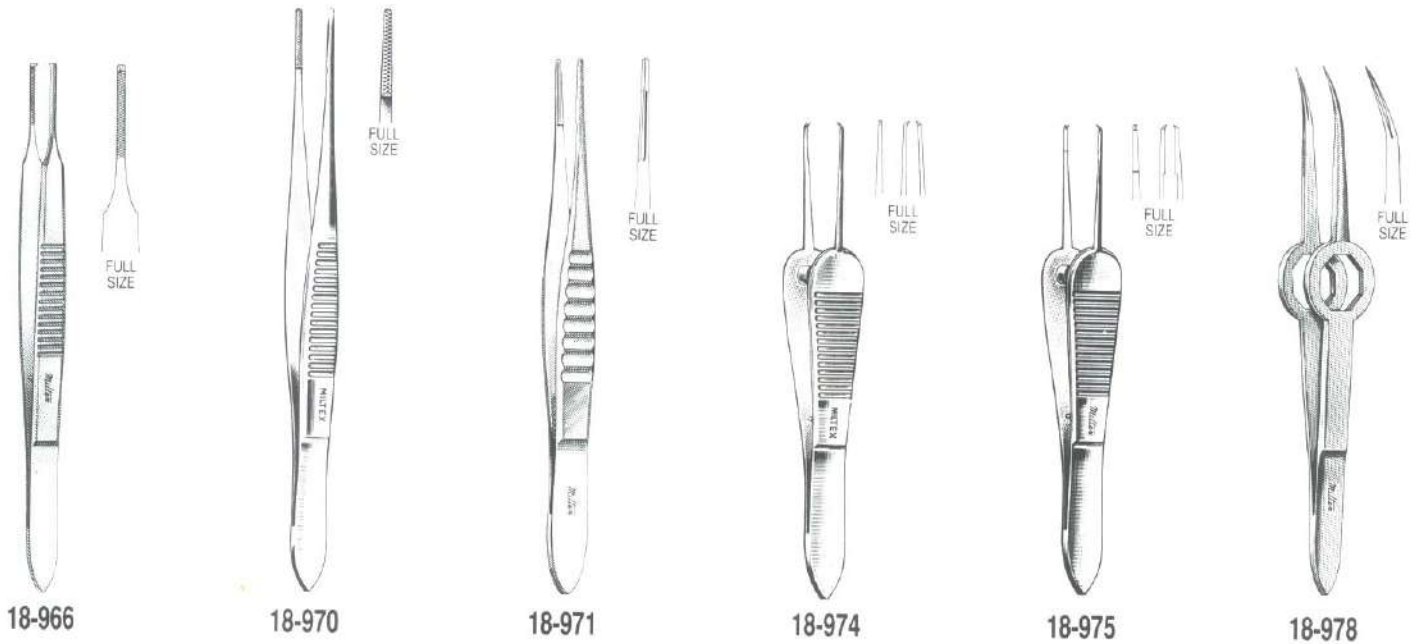

- 18-966 McCULLOUGH Suturing Forceps 4" (10.2 cm), cross serrated jaws 1.5 mm wide with 1 x 2 teeth
- 18-970 WILLS HOSPITAL Utility Forceps 4" (10.2 cm), with cross serrated tying platform 1.2 mm wide
- 18-971 BONACCOLTO Utility Forceps 4" (10.2 cm), longitudinal serrations with cross serrations on tip, 1.2 mm wide with tapered tips
- 18-974 SAUER Suturing Forceps 3½" (8.9 cm), 1 x 2 curved teeth, overlapping each other, 0.6 mm wide
- 18-975 MANHATTAN EYE & EAR Suturing Forceps 3½" (8.9 cm), with smooth platform, 1 x 2 curved teeth, overlapping each other, 0.7 mm wide
- 18-978 SCHAAF Foreign Body Forceps 3¾" (9.5 cm), grooved tips



18-980



18-1000
18-1002



18-1034



18-1050

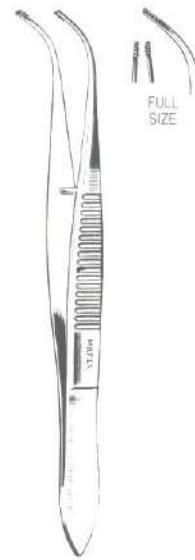

18-1058

- 18-980** THORPE Corneal and Splinter Forceps 4" (10.2 cm), very sharp points, fine serrated tips
- 18-1000** ARRUGA Capsule Forceps 4" (10.2 cm), standard curve
- 18-1002** ARRUGA Capsule Forceps 4" (10.2 cm), new curve
- 18-1034** MILTEX Extra-Capsular Forceps 4" (10.2 cm), improved pattern with 11 x 11 teeth, with long convex curve
- 18-1050** CASTROVIEJO Capsule Forceps 4" (10.2 cm), cross action, with stop to limit opening of blades
- 18-1058** SCHWEIGER Extra-Capsular Forceps 3¾" (9.5 cm), 4 x 5 teeth

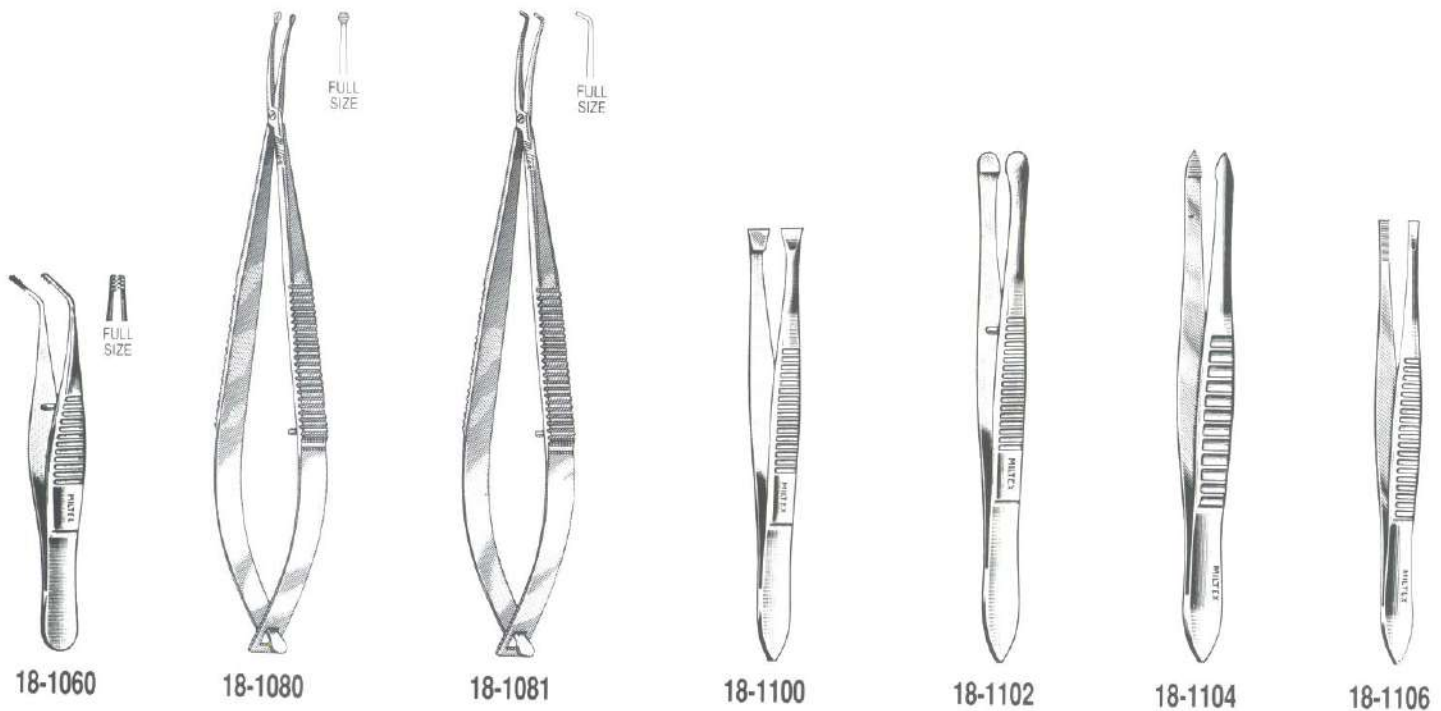

- 18-1060** FUCHS Extra-Capsular Forceps 2¾" (7 cm), 5 x 5 teeth
- 18-1080** SHEPARD Intraocular Lens Forceps 4½" (11.4 cm), 17 mm jaws, serrated tips
- 18-1081** CLAYMAN Intraocular Lens Forceps 4½" (11.4 cm), 15 mm jaws, smooth tips
- 18-1100** LITTAUER Cilia Forceps 3½" (8.9 cm), 4 mm wide jaws with fine horizontal serrations
- 18-1102** BEER Cilia Forceps 3½" (8.9 cm), 4 mm wide smooth jaws
- 18-1104** ZIEGLER Cilia Forceps 3½" (8.9 cm), 2 mm wide smooth jaws
- 18-1106** DOUGLAS Cilia Forceps 3½" (8.9 cm), thin tips 2.5 mm wide, with fine horizontal serrations



18-1107



18-1108



18-1110

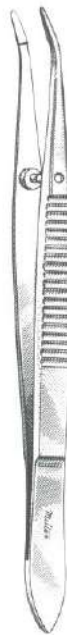

18-1111



18-1112



18-1114



18-1116

- 18-1107 SWISS Cilia and Suture Forceps 3¾" (9.5 cm), 3 mm wide precision fitted diagonal jaws
- 18-1108 BERGH Cilia Forceps 4¼" (10.8 cm), 10 mm wide jaws with horizontal serrations
- 18-1110 BERGH Cilia Forceps 3½" (8.9 cm), 5 mm wide jaws with horizontal serrations
- 18-1111 BARRAQUER Cilia and Suture Forceps 4½" (11.4 cm), with 5 mm smooth platform
- 18-1112 BENNETT Cilia Forceps 3" (7.6 cm), cup shaped jaws 3 mm diameter
- 18-1114 BEAUPRE Cilia Forceps 4½" (11.4 cm), smooth jaws 12 mm long, 45° angle
- 18-1116 GRADLE Cilia Forceps 4" (10.2 cm), precision ground jaws 1.4 mm wide



18-1136
18-1138



18-1150

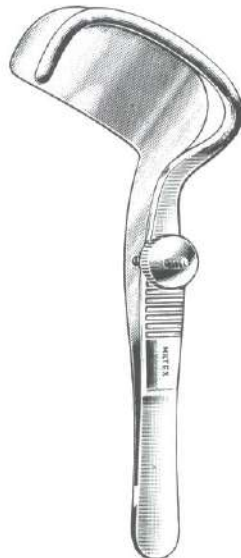

18-1160
18-1162



18-1170



18-1174



18-1178

- 18-1136 BERKE Ptosis Forceps 4" (10.2 cm), blades 20 mm long with longitudinal serrations, with slide lock
- 18-1138 BERKE Ptosis Forceps 4" (10.2 cm), blades 27 mm long with longitudinal serrations, with slide lock
- 18-1150 ERHARDT Lid Forceps 3½" (8.9 cm), serrated jaw 9.5 mm wide
- 18-1160 SNELLEN Entropium Forceps 3½" (8.9 cm), left, 35 mm wide plate
- 18-1162 SNELLEN Entropium Forceps 3½" (8.9 cm), right, 35 mm wide plate
- 18-1170 AYER Chalazion Forceps 3½" (8.9 cm), inside ring diameter 8.5 mm, solid blade 8 mm diameter
- 18-1174 LAMBERT Chalazion Forceps 3½" (8.9 cm), inside ring diameter 8 mm
- 18-1178 HUNT Chalazion Forceps 3¾" (9.5 cm), inside ring diameter 12 mm
- 18-1182 HEATH Chalazion Forceps 4" (10.2 cm), inside ring measures 12 x 14 mm

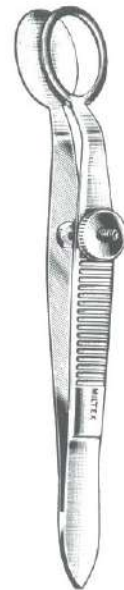

18-1182



18-1188



18-1190



18-1200 to 18-1204



18-1208



18-1220

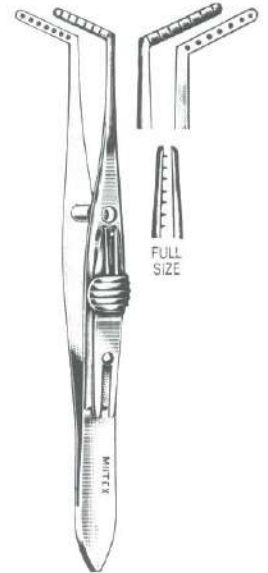

18-1260
18-1262

- 18-1188 SPENCER Chalazion Forceps 4" (10.2 cm), inside ring diameter 10 mm, with slide lock
- 18-1190 WIES Chalazion Forceps 4" (10.2 cm), inside ring measures 9 x 12 mm
- 18-1200 DESMARRES Chalazion Forceps 3½" (8.9 cm), small size, inside ring measures 11 x 17 mm
- 18-1202 DESMARRES Chalazion Forceps 3½" (8.9 cm), medium size, inside ring measures 12 x 23 mm
- 18-1204 DESMARRES Chalazion Forceps 3½" (8.9 cm), large size, inside ring measures 17 x 28 mm
- 18-1208 FRANCIS Chalazion Forceps 3¾" (9.5 cm), inside ring measures 12 x 14 mm
- 18-1220 PRINCE Trachoma Forceps 3½" (8.9 cm), rings measure 8 x 10 mm inside
- 18-1260 JAMESON Recession Forceps 3¾" (9.5 cm), left, with slide lock
- 18-1262 JAMESON Recession Forceps 3¾" (9.5 cm), right, with slide lock

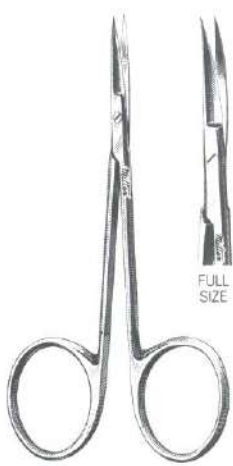

18-1392
18-1394



18-1396



18-1398

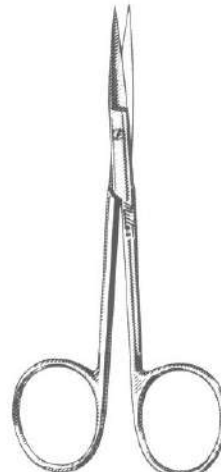

5-300
5-304



5D-303

- 18-1392 BONN Miniature Iris Scissors 3½" (8.9 cm), with 15 mm blades, straight
- 18-1394 BONN Miniature Iris Scissors 3½" (8.9 cm), with 15 mm blades, curved
- 18-1396 Iris Scissors 3½" (8.9 cm), with 20 mm blades, straight, delicate
- 18-1398 Iris Scissors 3½" (8.9 cm), with 20 mm blades, curved, delicate
- 5-300 Iris Scissors 4" (10.2 cm), straight, standard pattern
- 5-302 Iris Scissors 4" (10.2 cm), curved, standard pattern
- 5D-303 Iris Scissors 4½" (11.4 cm), curved sideways
- 5-304 Iris Scissors 4½" (11.4 cm), straight, standard pattern
- 5-306 Iris Scissors 4½" (11.4 cm), curved, standard pattern
- 5-308 Iris Scissors 4½" (11.4 cm), angular

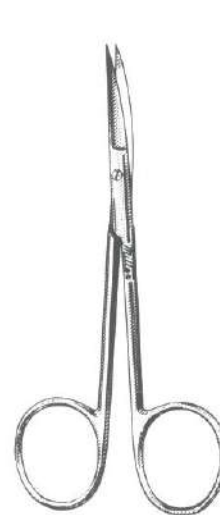

5-302
5-306

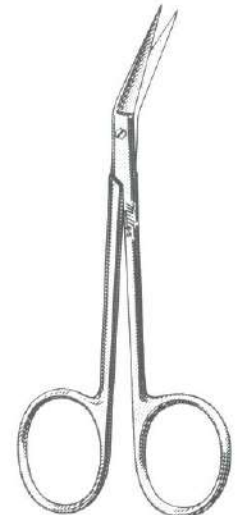

5-308



18-1404



18-1405

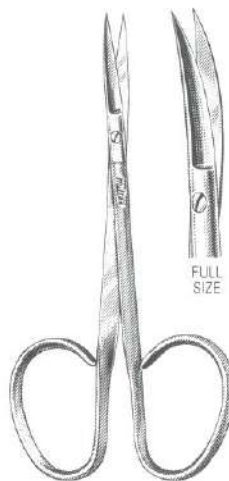

18-1415*
18-1416*



18-1417*
18-1418*



18-1419*

- 18-1404 MILTEX Iris Scissors 4" (10.2 cm), straight, heavy pattern
- 18-1405 MILTEX Iris Scissors 4" (10.2 cm), curved, heavy pattern
- 18-1415* Iris Scissors 4" (10.2 cm), straight, standard pattern, ribbon type
- 18-1416* Iris Scissors 4" (10.2 cm), curved, standard pattern, ribbon type
- 18-1417* Iris Scissors 3¾" (9.5 cm), straight, miniature pattern with 14 mm blades, ribbon type
- 18-1418* Iris Scissors 3¾" (9.5 cm), curved, miniature pattern with 14 mm blades, ribbon type
- 18-1419* Utility Scissors 3¾" (9.5 cm), curved blunt blades, 15 mm long, ribbon type

*Ribbon Type Scissors have extra large finger rings; shanks and rings have satin finish; blades are highly polished.

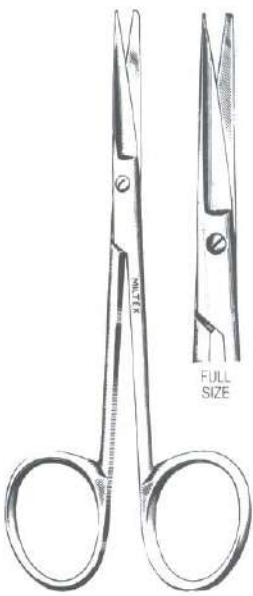

18-1420
18-1422

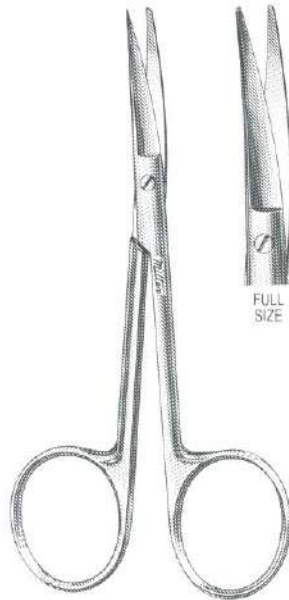

18-1426
18-1428



18-1430



18-1432

- 18-1420 KNAPP Iris Scissors 4" (10.2 cm), straight, sharp-blunt points
- 18-1422 KNAPP Iris Scissors 4" (10.2 cm), straight, blunt-blunt points
- 18-1426 KNAPP Iris Scissors 4" (10.2 cm), curved, sharp-blunt points
- 18-1428 KNAPP Iris Scissors 4" (10.2 cm), curved, blunt-blunt points
- 18-1430 Eye Scissors 4" (10.2 cm), with probe points, straight
- 18-1432 Eye Scissors 4" (10.2 cm), with probe points, curved
- 5-310 Eye Scissors 4½" (11.4 cm), with probe points, angled on side



5-310



5D-324



18-1440



5-312



5-314



18-1453*
18-1454*

5D-324 LAGRANGE Sclectomy Scissors 4¼" (10.8 cm), curved, one serrated blade, angled shanks

18-1440 WILMER Conjunctival and Utility Scissors, 4" (10.2 cm), angled on flat

5-312 Strabismus Scissors 4" (10.2 cm), straight, standard pattern

5-314 Strabismus Scissors 4" (10.2 cm), curved, standard pattern

18-1453* Strabismus Scissors 4¼" (10.8 cm), straight, ribbon type

18-1454* Strabismus Scissors 4¼" (10.8 cm), curved, ribbon type

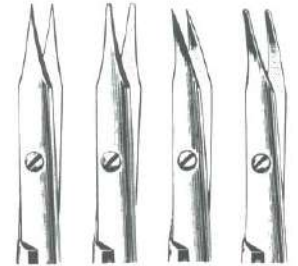

FULL SIZE

18-1460 to 18-1466

STEVENS TENOTOMY SCISSORS *tenotomias lej.*

4⅛" (10.5 cm)
With Short Blades

haga kerta 2, 3, 4

- 18-1460 Straight Sharp Points
- 18-1462 Straight Blunt Points
- 18-1464 Curved Sharp Points
- 18-1466 Curved Blunt Points

4½" (11.4 cm)
With Long Blades

haga kerta 2, 3, 4

- 18-1470 Straight Sharp Points
- 18-1472 Straight Blunt Points
- 18-1474 Curved Sharp Points
- 18-1476 Curved Blunt Points

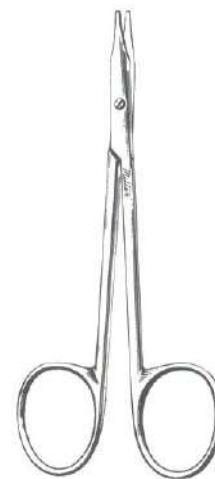

18-1460 to 18-1476



FULL SIZE

18-1470 to 18-1476

*Ribbon Type Scissors have extra large finger rings; shanks and rings have satin finish; blades are highly polished.

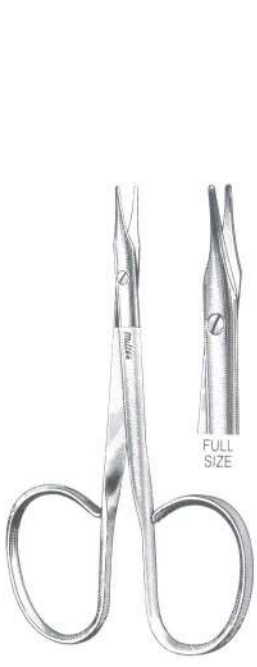

18-1477*
18-1478*

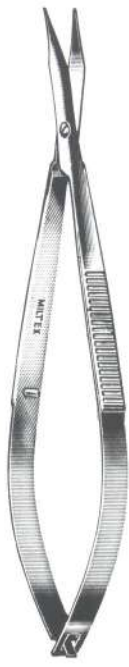

18-1480



18-1482



18-1484



18-1486

- 18-1477* STEVENS Tenotomy Scissors 3¾" (9.5 cm), straight, blunt points, ribbon type
- 18-1478* STEVENS Tenotomy Scissors 3¾" (9.5 cm), curved, blunt points, ribbon type
- 18-1480 WESTCOTT Utility Scissors 4½" (11.4 cm), curved, blunt tips
- 18-1482 SCHEIE-WESTCOTT Corneal Section Scissors 5" (12.7 cm), right, curved, blunt tips
- 18-1484 SCHEIE-WESTCOTT Corneal Section Scissors 5" (12.7 cm), left, curved, blunt tips
- 18-1486 WESTCOTT Stitch Scissors 4½" (11.4 cm), curved, sharp points
- 18-1487 WESTCOTT Tenotomy Scissors 5¼" (13.3 cm), right, wide handles
- 18-1488 WESTCOTT Tenotomy Scissors 5¼" (13.3 cm), left, wide handles

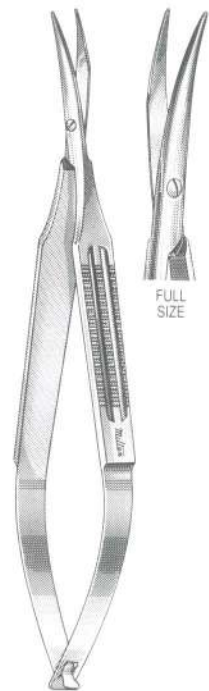

18-1487
18-1488

*Ribbon Type Scissors have extra large finger rings;
shanks and rings have satin finish;
blades are highly polished.



18-1494 to 18-1498

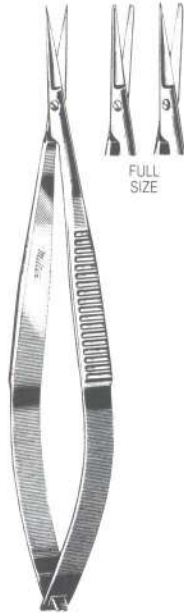

18-1510 to 18-1514



18-1516



18-1520
18-1521

- 18-1494 Enucleation Scissors 5" (12.7 cm), light curve
- 18-1496 Enucleation Scissors 5" (12.7 cm), medium curve
- 18-1498 Enucleation Scissors 5" (12.7 cm), full curve

- 18-1510 NOYES Iris Scissors 4½" (11.4 cm), straight, sharp-sharp points
- 18-1512 NOYES Iris Scissors 4½" (11.4 cm), straight, sharp-blunt points
- 18-1514 NOYES Iris Scissors 4½" (11.4 cm), straight, blunt-blunt points
- 18-1516 NOYES Iris Scissors 4½" (11.4 cm), curved, sharp-sharp points

- 18-1520 BARRAQUER Iris Scissors 2¼" (5.7 cm), angled 7 mm blades, sharp points
- 18-1521 BARRAQUER Iris Scissors 2¼" (5.7 cm), angled 7 mm blades, blunt points

- 18-1524 DeWECKER Iris Scissors 4¼" (10.8 cm), angled 7 mm blades, sharp-sharp points



18-1524

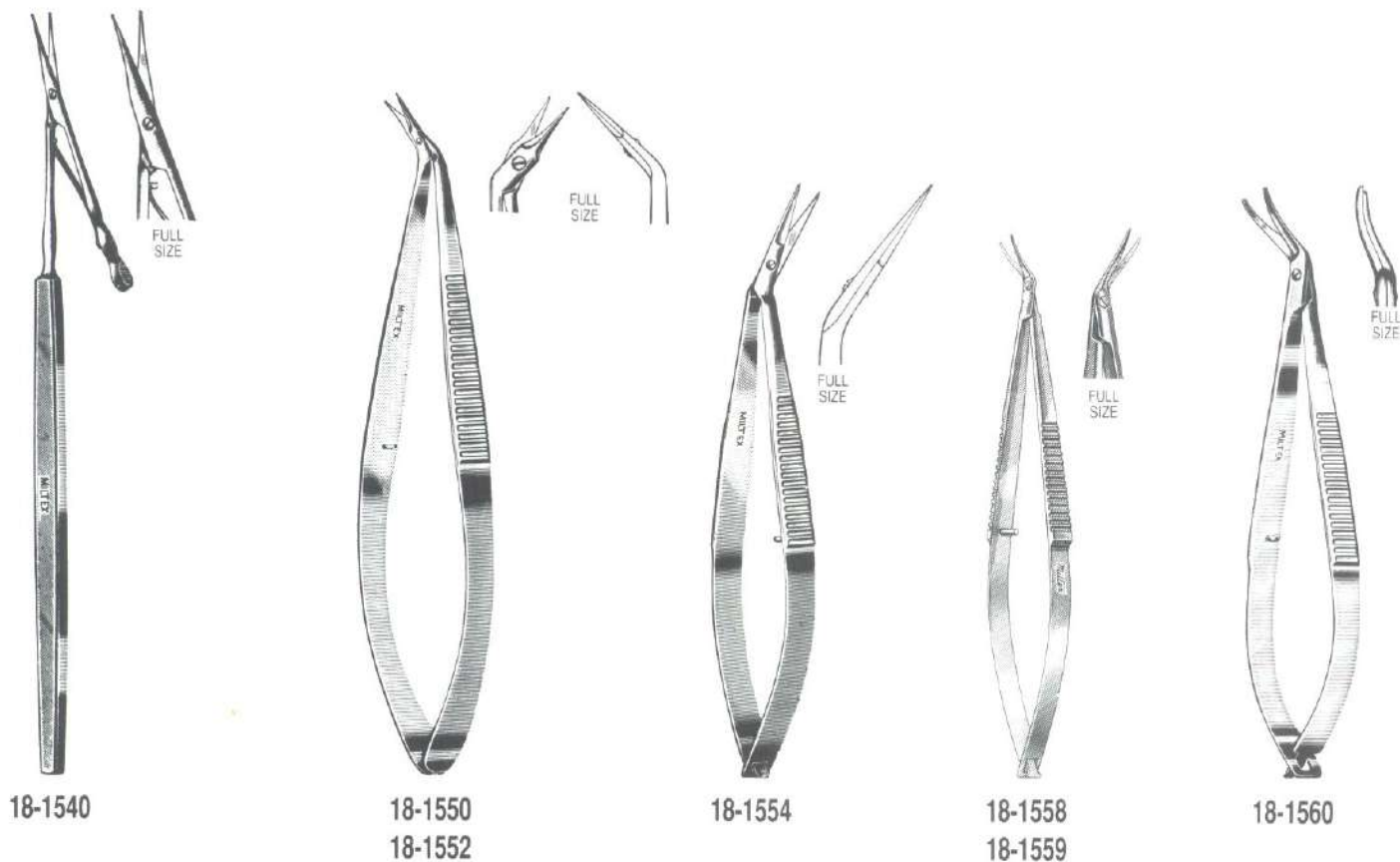

- 18-1540** NOYES Iridectomy Scissors 5½" (14 cm), straight 7 mm blades, sharp-sharp points
- 18-1550** McCLURE Iris Scissors 3¾" (9.5 cm), angled over edge, 4 mm blades with very delicate sharp points
- 18-1552** McCLURE Iris Scissors 3¾" (9.5 cm), angled on flat, 4 mm blades with very delicate sharp points
- 18-1554** McCLURE Iris Scissors 3¾" (9.5 cm), angled on flat, regular 10 mm blades with sharp points
- 18-1558** CASTROVIEJO Corneal Scissors 4" (10.2 cm), right, sub-miniature for micro surgery, 6 mm blades
- 18-1559** CASTROVIEJO Corneal Scissors 4" (10.2 cm), left, sub-miniature for micro surgery, 6 mm blades
- 18-1560** CASTROVIEJO Corneal Section Scissors 4½" (11.4 cm), right, inner blade 1 mm longer, blunt tips
- 18-1562** CASTROVIEJO Corneal Section Scissors 4½" (11.4 cm), left, inner blade 1 mm longer, blunt tips



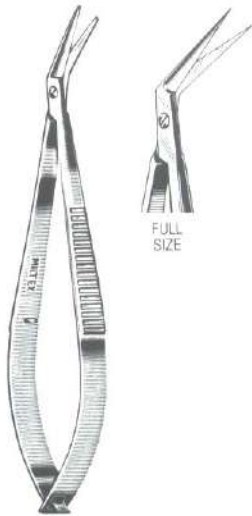

18-1570
18-1572

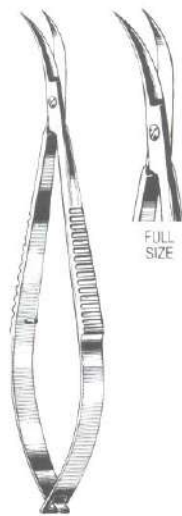

18-1576



18-1578

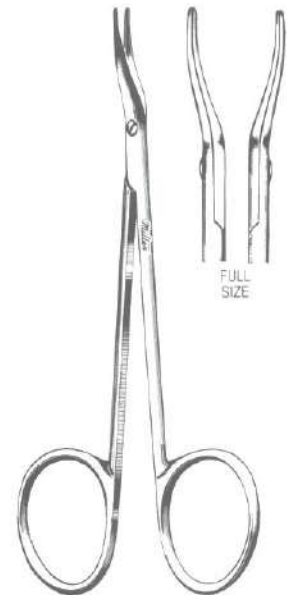

18-1594
18-1596

- 18-1570 CASTROVIEJO Keratoplasty Scissors 3 $\frac{3}{4}$ " (9.5 cm), angled blades 11 mm, sharp points
- 18-1572 CASTROVIEJO Corneal Scissors 3 $\frac{3}{4}$ " (9.5 cm), angled blades 11 mm, blunt points
- 18-1576 CASTROVIEJO Corneal Scissors 3 $\frac{3}{4}$ " (9.5 cm), curved, sharp points
- 18-1578 CASTROVIEJO Corneal Scissors 3 $\frac{3}{4}$ " (9.5 cm), curved, blunt points
- 18-1594 McGUIRE Corneal Scissors 4 $\frac{1}{8}$ " (10.5 cm), right
- 18-1596 McGUIRE Corneal Scissors 4 $\frac{1}{8}$ " (10.5 cm), left
- 18-1600 AEBLI Corneal Scissors 4" (10.2 cm), straight
- 18-1602 AEBLI Corneal Scissors 4" (10.2 cm), angled on flat, right
- 18-1604 AEBLI Corneal Scissors 4" (10.2 cm), angled on flat, left

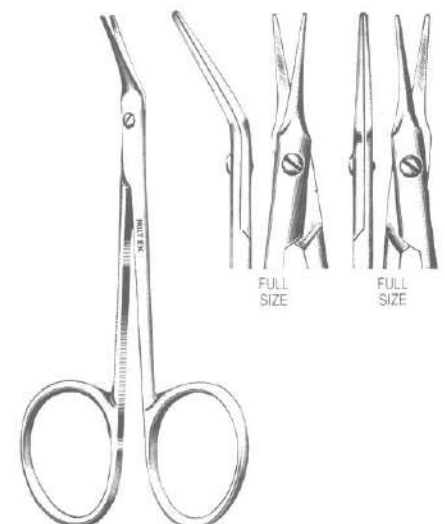

18-1600 to 18-1604

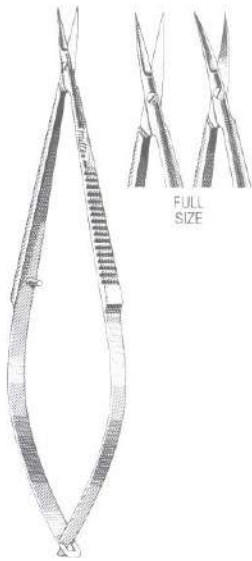

18-1618
18-1619

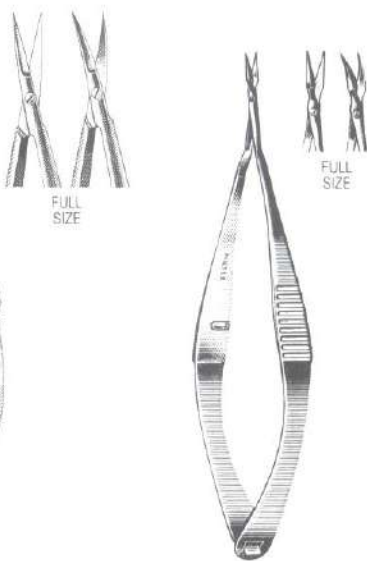

18-1620
18-1622

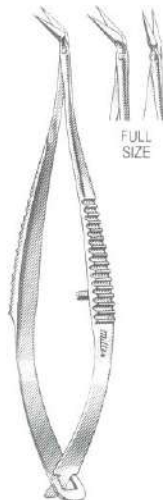

18-1623
18-1624



18-1625
18-1626

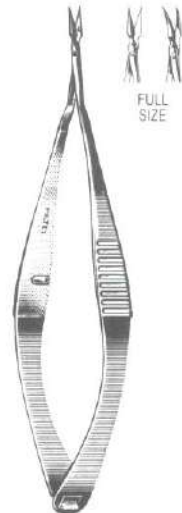

18-1630
18-1631

- 18-1618 Micro Iris Scissors 4" (10.2 cm), straight, sharp points
- 18-1619 Micro Iris Scissors 4" (10.2 cm), curved, sharp points
- 18-1620 VANNAS Capsulotomy Scissors 3/4" (8.3 cm), straight, very delicate sharp points
- 18-1622 VANNAS Capsulotomy Scissors 3/4" (8.3 cm), curved, very delicate sharp points
- 18-1623 VANNAS Capsulotomy Scissors 3/4" (8.3 cm), angled to side, very delicate sharp points
- 18-1624 VANNAS Capsulotomy Scissors 3/4" (8.3 cm), angled on flat, very delicate sharp points
- 18-1625 McPHERSON-VANNAS Micro Iris Scissors 3/4" (8.3 cm), straight, sharp points
- 18-1626 McPHERSON-VANNAS Micro Iris Scissors 3/4" (8.3 cm), curved, sharp points
- 18-1630 Micro-VANNAS Scissors 3/4" (8.3 cm), straight ultra fine blades
- 18-1631 Micro-VANNAS Scissors 3/4" (8.3 cm), curved ultra fine blades
- 18-1633 Micro Scissors 3/4" (8.3 cm), straight super fine blades
- 18-1634 Micro Scissors 3/4" (8.3 cm), curved super fine blades
- 18-1716 HOLTH Corneoscleral Punch 3 1/2" (8.9 cm), 1 mm bite
- 18-1718 HOLTH Corneoscleral Punch 3 1/2" (8.9 cm), 1.5 mm bite

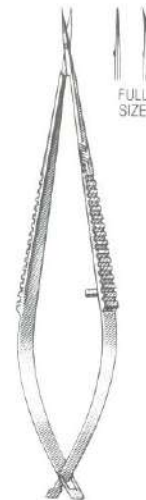

18-1633
18-1634



18-1716
18-1718

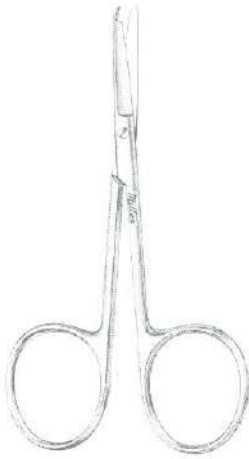

9-100

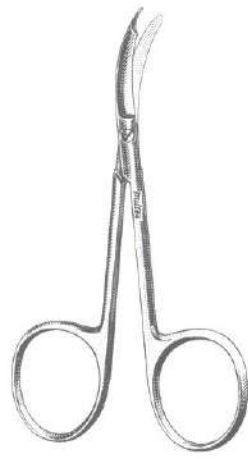

9-101

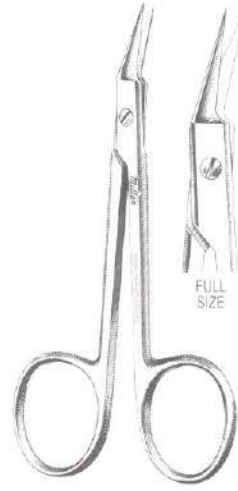

9-110

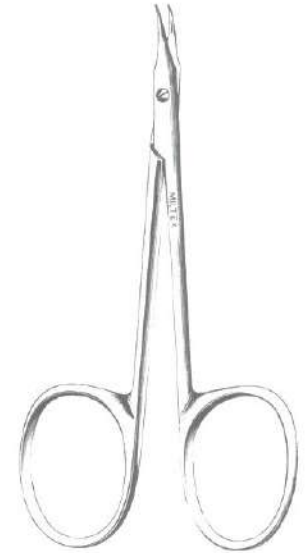

18-1652

- 9-100 SPENCER Stitch Scissors 3½" (8.9 cm), straight, delicate
- 9-101 SHORTBENT Stitch Scissors 3½" (8.9 cm), curved to side, delicate
- 9-110 O'BRIEN Stitch Scissors 3¾" (9.5 cm), angled to side, sharp points
- 18-1652 Eye Suture (GRADLE) Scissors 3¾" (9.5 cm), slightly curved, sharp points
- 18-1653* Eye Suture Scissors 4" (10.2 cm), ribbon type, slightly curved, sharp points

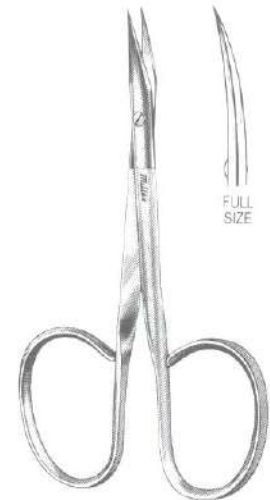

18-1653*

*Ribbon Type Scissors have extra large finger rings; shanks and rings have satin finish; blades are highly polished.



18-1800



18-1810

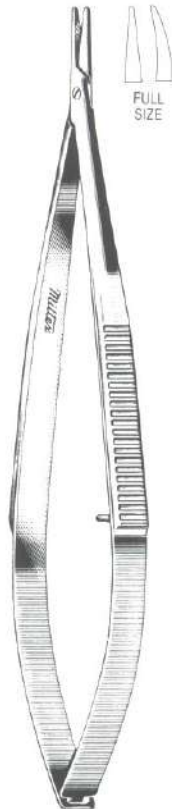

18-1820
18-1824



18-1828
18-1832

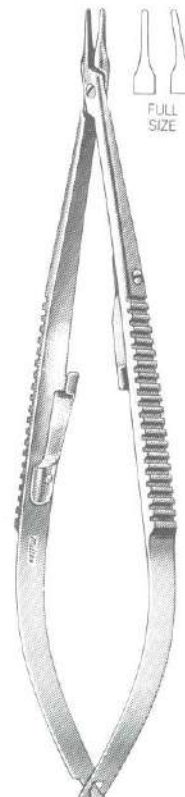

18-1831
18-1833

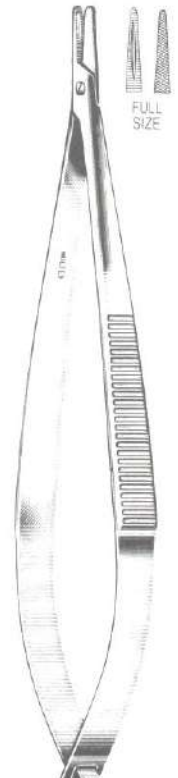

18-1834

- 18-1800 KALT Needle Holder 5¼" (13.3 cm), standard model, delicate jaws
- 18-1810 GREEN Needle Holder and Suturing Forceps 4¼" (10.8 cm), angled jaws, double end
- 18-1820 CASTROVIEJO Needle Holder 5½" (14 cm), straight, without lock
- 18-1824 CASTROVIEJO Needle Holder 5½" (14 cm), curved, without lock
- 18-1828 CASTROVIEJO Needle Holder 5½" (14 cm), straight, with lock
- 18-1832 CASTROVIEJO Needle Holder 5½" (14 cm), curved, with lock
- 18-1831 CASTROVIEJO Needle Holder 5½" (14 cm), straight, extra delicate jaws, with lock
- 18-1833 CASTROVIEJO Needle Holder 5½" (14 cm), curved, extra delicate jaws, with lock
- 18-1834 PATON Needle Holder 4½" (11.4 cm), straight, without lock

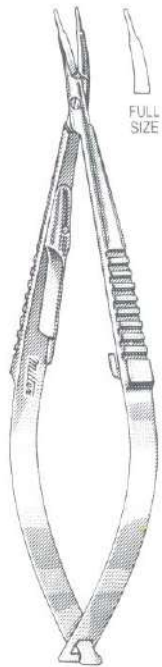

18-1837

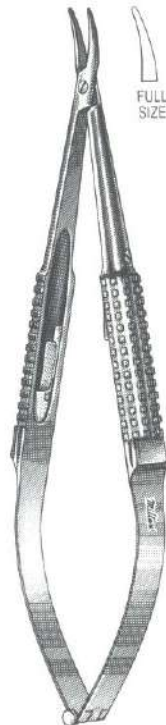

18-1838
18-1839

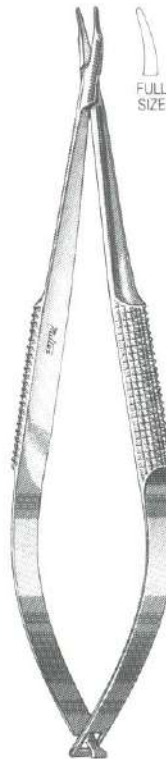

18-1840

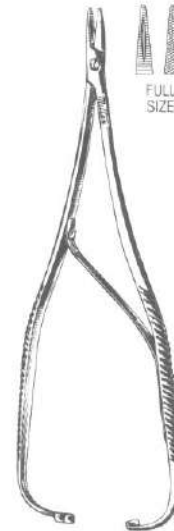

8-26



18-1858

- 18-1837 McPHERSON Needle Holder for microsurgery 4" (10.2 cm), curved smooth tapered jaws
- 18-1838 BARRAQUER Needle Holder 5" (12.7 cm), curved, without lock, 10 mm wide hollow round handle
- 18-1839 BARRAQUER Needle Holder 5" (12.7 cm), curved, with lock, 10 mm wide hollow round handle
- 18-1840 BARRAQUER Needle Holder 5 1/8" (13 cm), curved, without lock delicate tapered jaws, 8 mm wide round handle
- 8-26 BOYNTON Needle Holder 5" (12.7 cm), delicate
- 18-1858 STEVENS Needle Holder 6 1/2" (16.5 cm), with ratchet lock

CARN-N-SERT NEEDLE HOLDERS with tungsten carbide inserts insure firm holding of needles and sutures

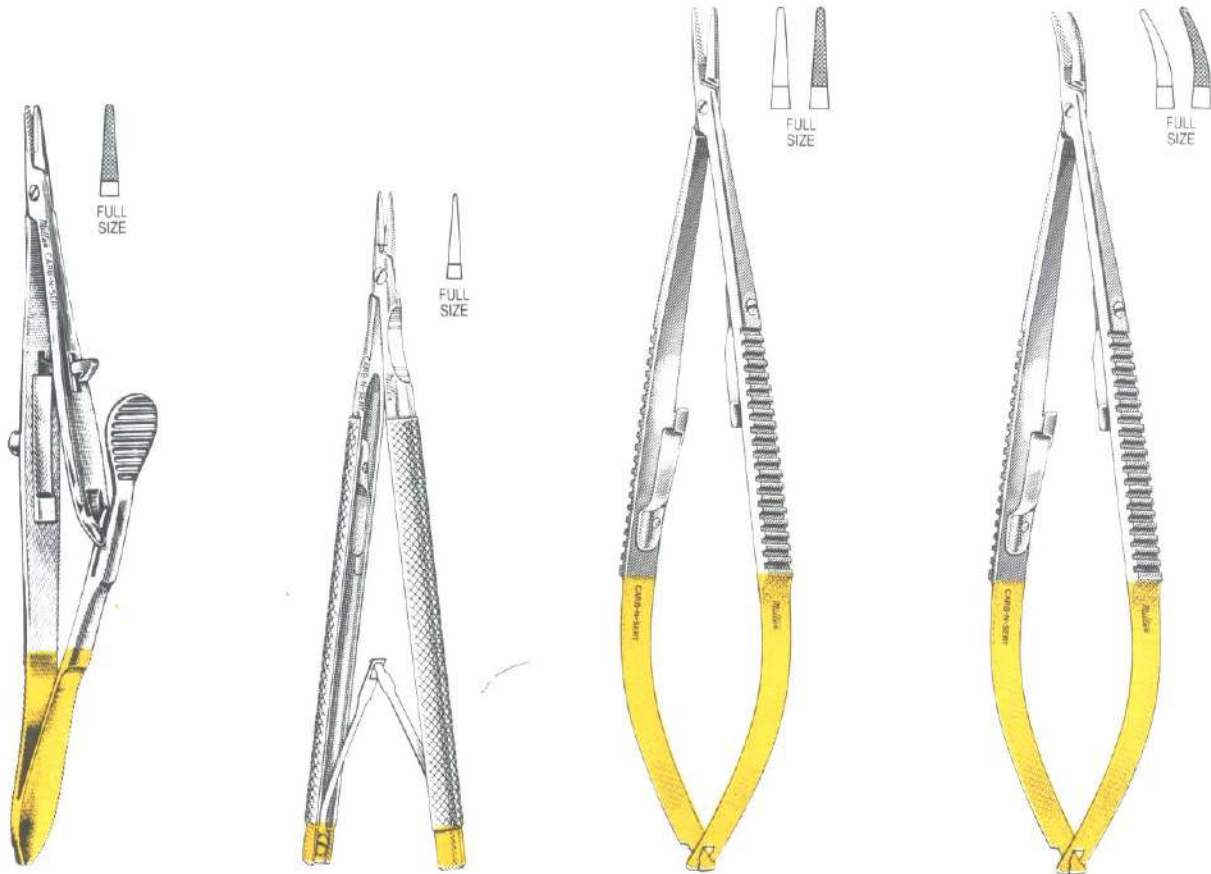

18-1800TC

18-1816TC

18-1828TC
18-1828A-TC

18-1832TC
18-1832A-TC

- 18-1800TC** KALT Needle Holder 5½" (14 cm), serrated Carb-N-Sert jaws 16000 teeth p. sq. inch
- 18-1816TC** MILTEX-CASTROVIEJO Needle Holder 4⅛" (10.5 cm), round handles, with lock, delicate smooth Carb-N-Sert jaws
- 18-1828TC** CASTROVIEJO Needle Holder 5½" (14 cm), straight, with lock, smooth Carb-N-Sert jaws
- 18-1828A-TC** CASTROVIEJO Needle Holder 5½" (14 cm), straight, with lock, serrated Carb-N-Sert jaws 16000 teeth p. sq. inch
- 18-1832TC** CASTROVIEJO Needle Holder 5½" (14 cm), curved, with lock, smooth Carb-N-Sert jaws
- 18-1832A-TC** CASTROVIEJO Needle Holder 5½" (14 cm), curved, with lock, serrated Carb-N-Sert jaws 16000 teeth p. sq. inch



7-280
7-284



7-290
7-294

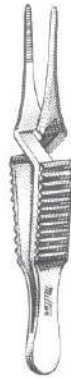

7-310

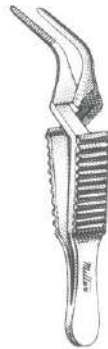

7-315



7-8
7-10
18-1934
18-1936



FULL
SIZE

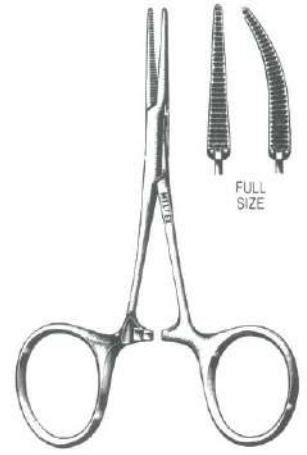

7-24
7-26



FULL
SIZE

- 7-280 Serrefine 1½" (3.8 cm), straight, with suture hole
- 7-284 Serrefine 2½" (6.4 cm), straight, with suture hole
- 7-290 Serrefine 1½" (3.8 cm), curved, with suture hole
- 7-294 Serrefine 2½" (6.4 cm), curved, with suture hole
- 7-310 DIETHRICH Micro Bulldog clamp 1⅞" (4.7 cm), straight jaws 8 mm x 1.2 mm
- 7-315 DIETHRICH Micro Bulldog clamp 1¾" (4.4 cm), angled jaws 8 mm x 1.2 mm
- 7-8 HALSTED Mosquito Forceps 5" (12.7 cm), straight, extra delicate
- 7-10 HALSTED Mosquito Forceps 5" (12.7 cm), curved, extra delicate
- 18-1934 HALSTED Mosquito Forceps 5" (12.7 cm), straight, Non-Magnetic
- 18-1936 HALSTED Mosquito Forceps 5" (12.7 cm), curved, Non-Magnetic
- 7-24 HARTMAN Mosquito Forceps 3½" (8.9 cm), straight, delicate
- 7-26 HARTMAN Mosquito Forceps 3½" (8.9 cm), curved, delicate
- 17-2600 JACOBSON Micro Mosquito Forceps 5" (12.7 cm), straight, extremely delicate
- 17-2602 JACOBSON Micro Mosquito Forceps 5" (12.7 cm), curved, extremely delicate

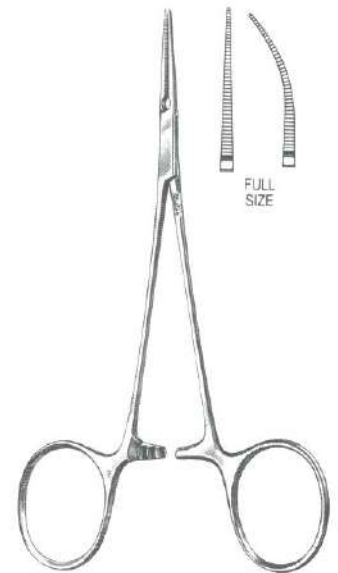

17-2600
17-2602



FULL
SIZE



ARRUGA LACRIMAL TREPHINES

Without Center Point	Diameter	Center Point
18-1950-7	7 mm	18-1952-7
18-1950-8	8 mm	18-1952-8
—	9 mm	18-1952-9
—	10 mm	18-1952-10

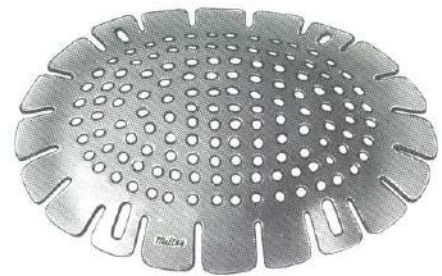

18-2200

- 18-1960 FREER Chisel 6½" (16.5 cm), curved blade 4 mm wide
- 18-1962 WEST Lacrimal Sac Chisel 6¼" (15.9 cm), straight blade 5 mm wide
- 18-1964 WEST Lacrimal Gouge 6¼" (15.9 cm), straight blade 4.5 mm wide
- 18-1968 FREER Elevator 7" (17.8 cm), double end sharp and blunt blades 5 mm wide
- 18-1990 KERRISON RONGEUR 3" (7.6 cm) shaft, size 0, 3.5 mm bite
- 18-1992 KERRISON RONGEUR 3" (7.6 cm) shaft, size 1, 4 mm bite
- 18-1994 KERRISON RONGEUR 3" (7.6 cm) shaft, size 2, 4.5 mm bite
- 18-1996 KERRISON RONGEUR 3" (7.6 cm) shaft, size 3, 5 mm bite
- 18-2200 FOX Eye Shields, aluminum, pkg. 12

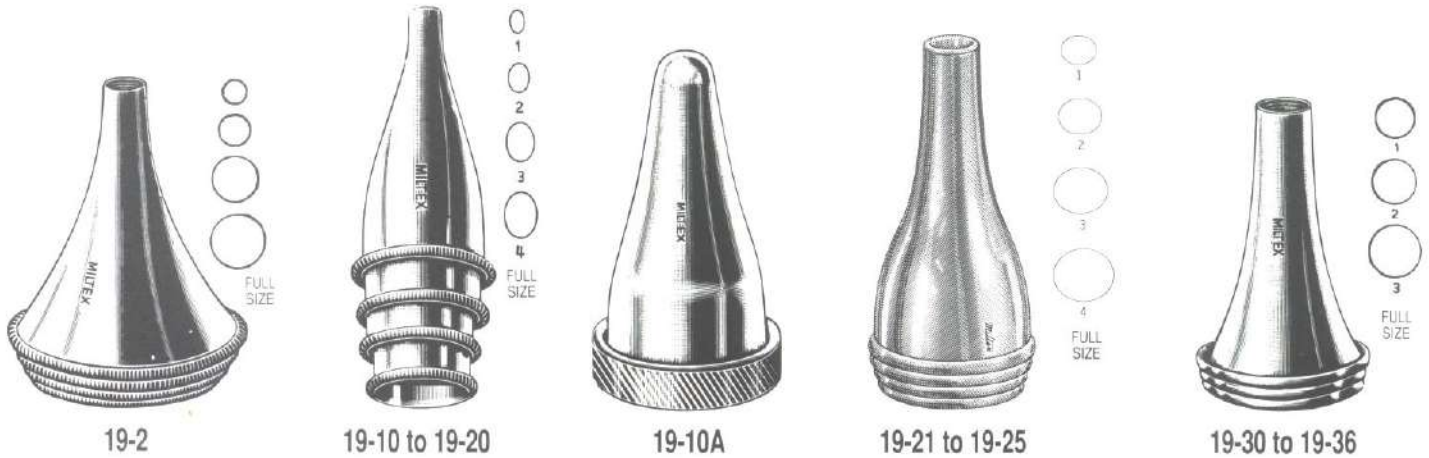

- BOUCHERON EAR SPECULA, Round, Chrome**
- 19-2** Set of 4 sizes 1, 2, 3 and 4
- 19-2-1** Single size 1 4.5 mm
- 19-2-2** Single size 2 5.5 mm
- 19-2-3** Single size 3 6.5 mm
- 19-2-4** Single size 4 7.5 mm
- GRUBER EAR SPECULA, Oval, Child and Infant Sizes, Light Short Pattern, Chrome**
- 19-10** Set of 4 sizes 1, 2, 3 and 4 with screw top case
- 19-12** Set of 4 sizes 1, 2, 3 and 4 without case
- 19-14** Single size 1 2x3 mm
- 19-16** Single size 2 3x4 mm
- 19-18** Single size 3 4x5 mm
- 19-20** Single size 4 5x6 mm
- 19-10A** Case only for set of 4 Gruber Specula, child & infant sizes

- GRUBER EAR SPECULA, Oval, Standard Adult Sizes, Long Pattern, Chrome**
- 19-21** Set of 4 sizes 1, 2, 3 and 4
- 19-22** Single size 1 4x5 mm
- 19-23** Single size 2 5x6 mm
- 19-24** Single size 3 6x7 mm
- 19-25** Single size 4 7x8 mm
- TOYNBEE EAR SPECULA, Round, Chrome**
- 19-30** Set of 3 sizes 1, 2 and 3
- 19-32** Single size 1 4 mm
- 19-34** Single size 2 5 mm
- 19-36** Single size 3 6 mm



HARTMAN EAR SPECULA, Round

- 19-40 Set of 3 sizes 3, 4 and 5 mm
- 19-48 Set of 4 sizes 4, 5, 6 and 7 mm
- 19-48-A Single size 3 mm
- 19-48-B Single size 4 mm
- 19-48-C Single size 5 mm
- 19-48-D Single size 6 mm
- 19-48-E Single size 7 mm

FARRIOR EAR SPECULA, Oval, angled end, nonglare stainless

- 19-50-1 Single size 1 3 x 4 mm
- 19-50-2 Single size 2 4 x 5 mm
- 19-50-3 Single size 3 4.5 x 5.5 mm
- 19-50-4 Single size 4 5 x 6 mm
- 19-50-5 Single size 5 5.5 x 6.5 mm
- 19-50-6 Single size 6 6 x 7 mm
- 19-50-7 Single size 7 6.5 x 7.5 mm
- 19-50-8 Single size 8 7 x 8 mm
- 19-50-9 Single size 9 7.5 x 8.5 mm
- 19-70 BRUENING Magnifier Otoscope, Chrome, 3.5x magnif., with 3 specula, small, medium and large sizes; complete with inflation bulb and tubing, in fitted case
- 19-71 Set of 3 specula, small, medium and large sizes for Bruening Otoscope, chrome
- 19-71-1 Single speculum, small size, chrome
- 19-71-2 Single speculum, medium size, chrome
- 19-71-3 Single speculum, large size, chrome

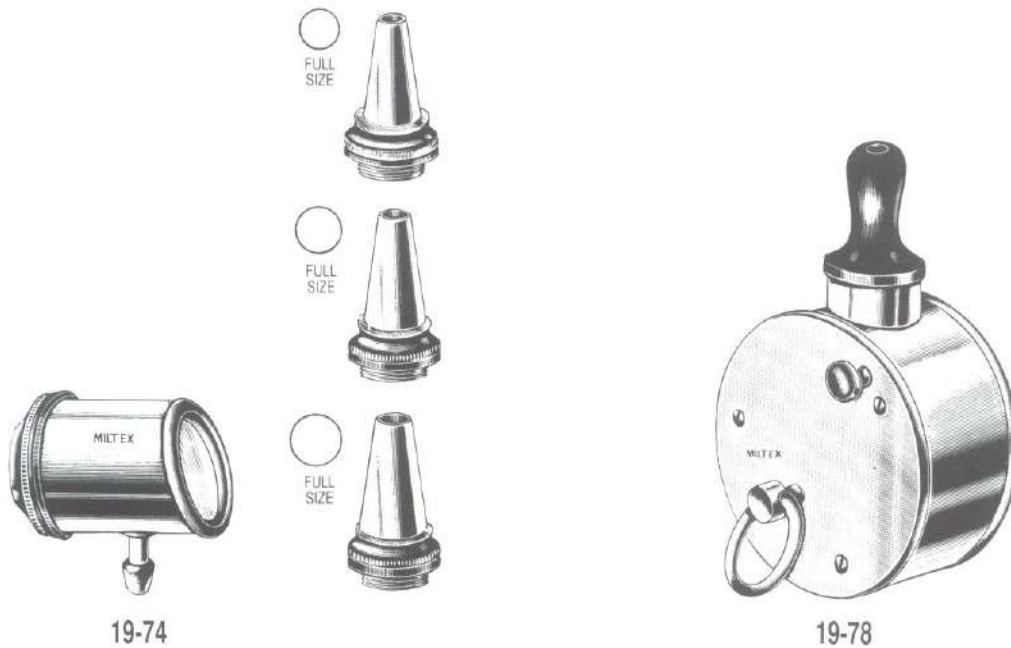

- 19-74 SIEGEL Magnifier Otoscope, chrome, 3.15x magnif., with 3 specula, small, medium and large sizes; complete with inflation bulb and tubing
- 19-75 Rubber Bulb with tubing for Bruening and Siegel Otoscopes
- 19-78 BARANY Noise Apparatus, with hard rubber ear tip



19-100



19-102

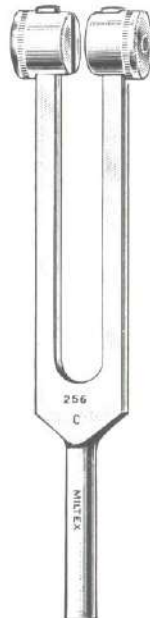

19-104



19-106



19-108



19-110



19-112

MILTEX TUNING FORKS, Aluminum Alloy

- 19-100 C-64 vibrations
- 19-102 C-128 vibrations
- 19-104 C-256 vibrations
- 19-106 C-512 vibrations
- 19-108 C-1024 vibrations
- 19-110 C-2048 vibrations
- 19-112 C-4096 vibrations

- 19-120 Set of 5 Tuning Forks,
C-128, C-256, C-512,
C-1024 and C-2048 in
fitted molded vinyl
zippered case

- 19-120A Fitted molded vinyl zippered
case only for tuning fork set



19-120
19-120A

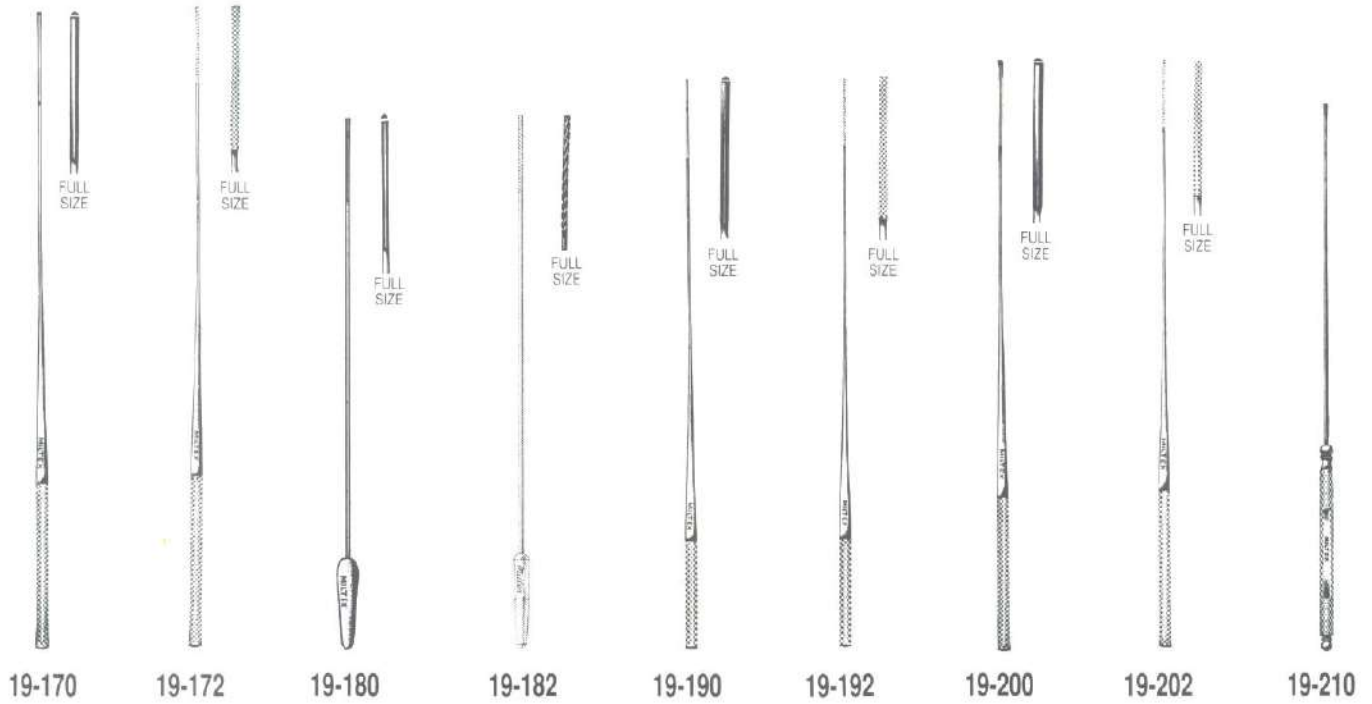

- 19-170 UEBE Applicator 7" (17.8 cm), triangular tip
- 19-172 UEBE Applicator 7" (17.8 cm), cross serrated tip
- 19-180 BROWN Applicator 6" (15.2 cm), triangular tip, copper
- 19-182 BROWN Applicator 6" (15.2 cm), cross serrated tip, copper
- 19-190 LATHBURY Applicator 5½" (14 cm), triangular tip
- 19-192 LATHBURY Applicator 5½" (14 cm), cross serrated tip
- 19-200 FARRELL Applicator 6½" (16.5 cm), triangular tip
- 19-202 FARRELL Applicator 6½" (16.5 cm), cross serrated tip
- 19-210 BUCK (SPENCER) Ear Probe 5½" (14 cm), sterling shaft
- 19-220 DAY Ear Hook 6½" (16.5 cm), small size
- 19-222 DAY Ear Hook 6½" (16.5 cm), large size
- 19-226 ALLPORT Mastoid Searcher 6½" (16.5 cm), with ball tip
- 19-228 GROSS Ear Hook and Spoon 5" (12.7 cm)





19-240 to 19-248

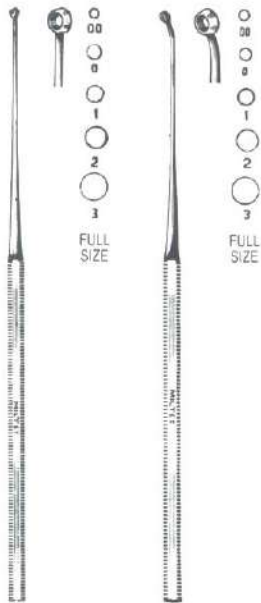

19-260 to 19-278

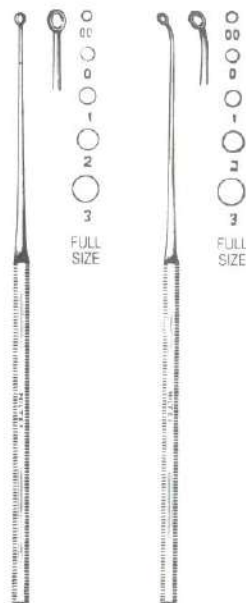

19-280 to 19-298



19-300
19-302



19-314 to 19-318

HARTMAN EUSTACHIAN CATHETERS, bulbous tip, silver plated

19-240	Size 00	19-246	Size 2
19-242	Size 0	19-248	Size 3
19-244	Size 1		

BUCK EAR CURETTES, 6½" (16.5 cm)

SHARP			BLUNT	
Straight	Angled	Size	Straight	Angled
19-260	19-270	00	19-280	19-290
19-262	19-272	0	19-282	19-292
19-264	19-274	1	19-284	19-294
19-266	19-276	2	19-286	19-296
19-268	19-278	3	19-288	19-298

19-300 SHAPLEIGH Ear Curette 6" (15.2 cm), small size, serrated loop
19-302 SHAPLEIGH Ear Curette 6" (15.2 cm), large size, serrated loop

19-314 BILLEAU Flexible Ear Loop 6½" (16.5 cm), small size No. 1
19-316 BILLEAU Flexible Ear Loop 6½" (16.5 cm), medium size No. 2
19-318 BILLEAU Flexible Ear Loop 6½" (16.5 cm), large size No. 3

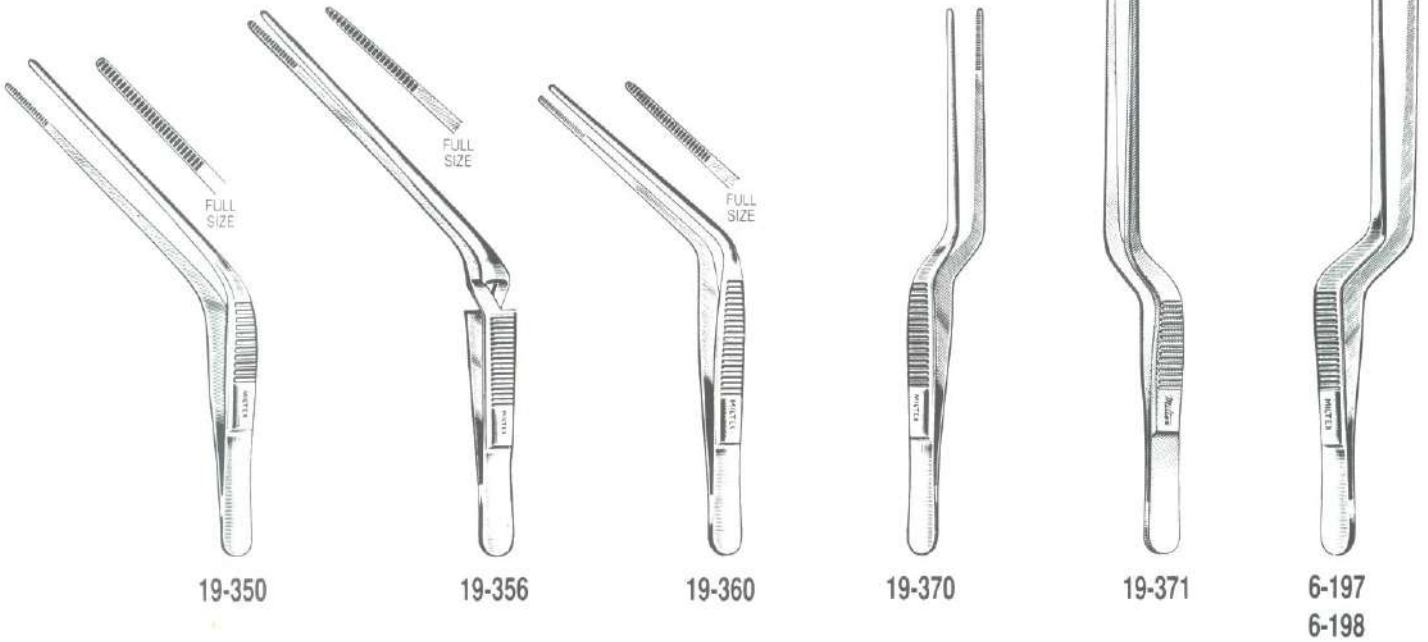

- 19-350 WILDE Ear Forceps 5" (12.7 cm), angular with serrated tips
- 19-356 WILDE Ear Forceps 5¼" (13.3 cm), cross action, angular with serrated tips
- 19-360 BLAKE Ear Forceps 4½" (11.4 cm), very delicate, angular with serrated tips
- 19-370 LUCAE Ear Forceps 5½" (14 cm), bayonet shape with serrated tips
- 19-371 JANSEN Ear Forceps 6¼" (15.9 cm), bayonet, extra delicate with 2 mm wide serrated tips
- 6-197 JANSEN (GRUENWALD) Ear Forceps 6¼" (15.9 cm), bayonet shape with serrated tips
- 6-198 ADSON Bayonet Dressing Forceps 8¼" (21 cm), serrated tips

EAR SYRINGES, All Brass, Chrome Plated, with precision ground plunger, shaft graduated in ½ (.015 liter) ounces, complete with one tapered and one short bulbous tip, easily disassembled for sterilization.

Without Shield	Capacity	With Shield
19-380	2 oz. (.06 liter)	19-381
19-382	3 oz. (.09 liter)	19-383
19-384	4 oz. (.12 liter)	19-385

- 19-390 Short Bulbous Tip only, for Ear Syringes, chrome
- 19-394 Taper Tip only, for Ear Syringes, chrome
- 19-396 Shield only, for Ear Syringes, chrome

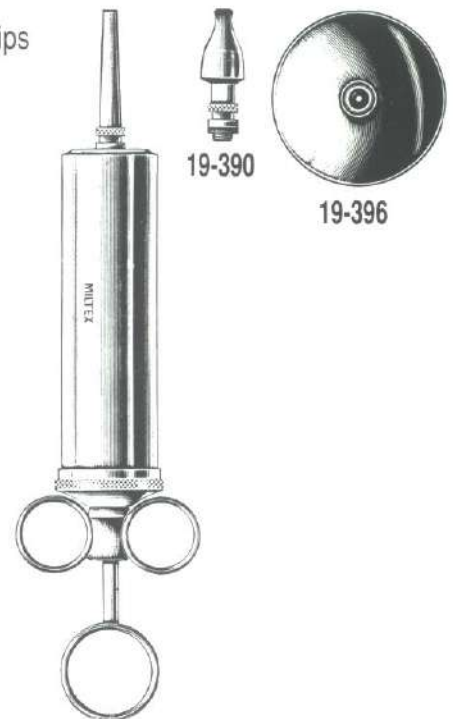

19-380 to 19-396

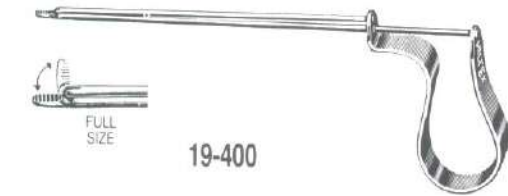

19-400



19-404

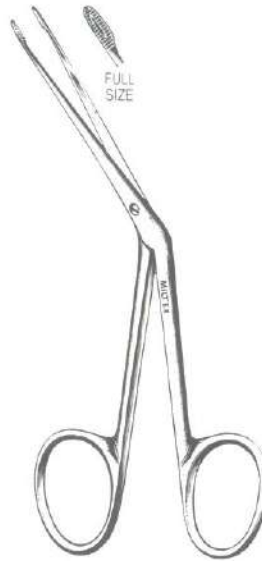

19-410

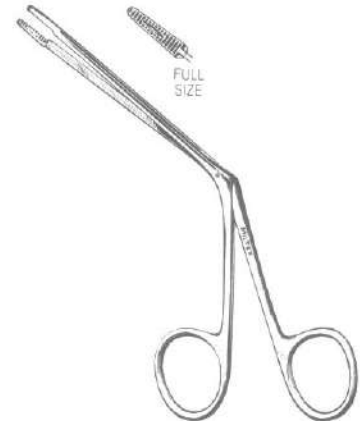

19-414

- 19-400 QUIRE Mechanical Finger 4" (10.2 cm), for removal of foreign bodies, spring handle
- 19-404 NOYES Alligator Forceps 4" (10.2 cm), spring handle
- 19-410 HARTMAN Ear Forceps 5" (12.7 cm), delicate serrated jaws 2.5 x 6 mm
- 19-414 LITTAUER Ear Forceps 4¾" (12.1 cm), delicate serrated jaws 2.5 x 8 m

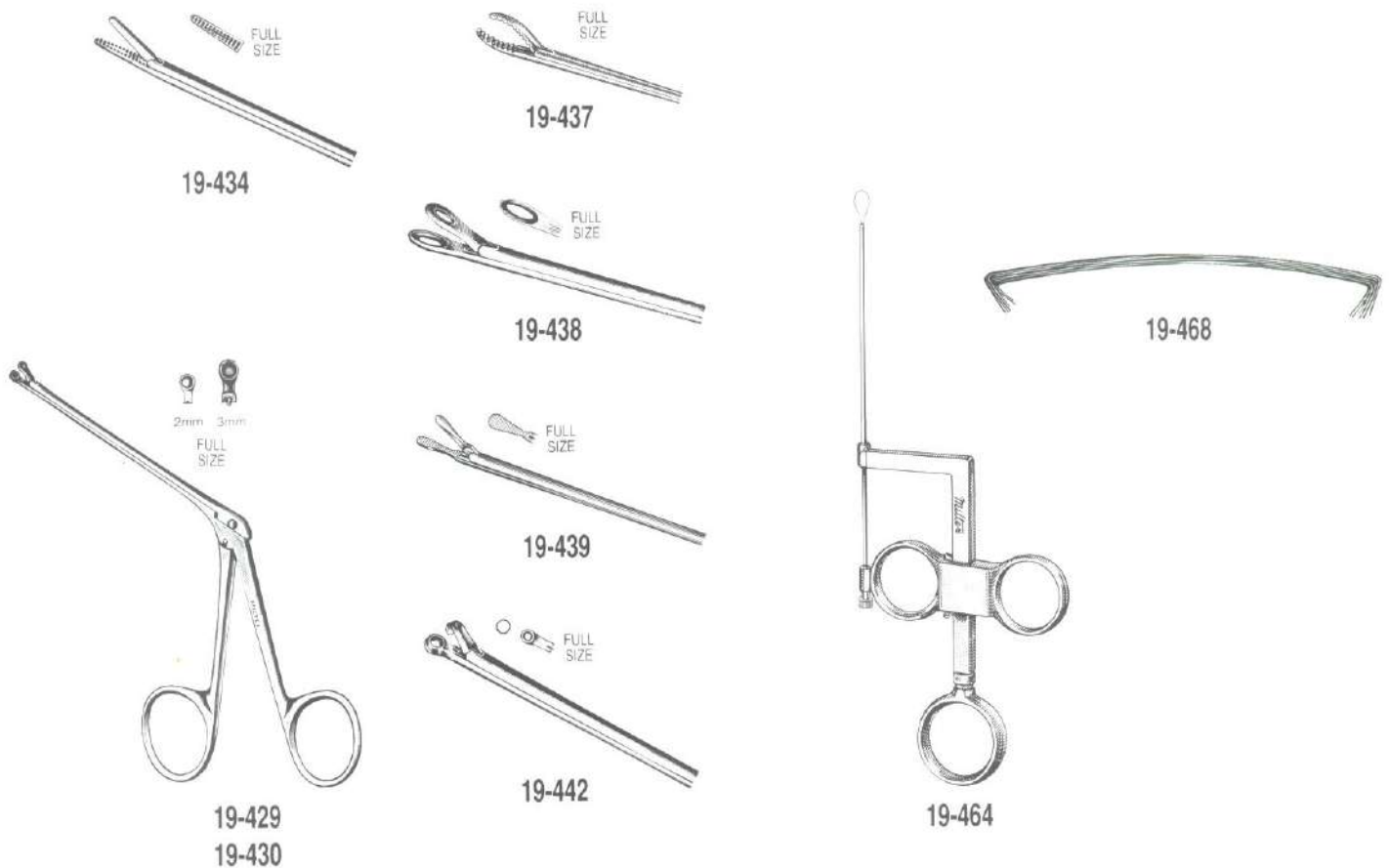

- 19-429 HARTMAN-HERZFELD Cup-Shape Forceps, alligator type, 3" (7.6 cm) shaft, 2 mm cup
- 19-430 HARTMAN-HERZFELD Cup-Shape Forceps, alligator type, 3" (7.6 cm) shaft, 3 mm cup
- 19-434 HARTMAN-NOYES Ear Forceps, alligator type, 3" (7.6 cm) shaft, serrated jaws
- 19-437 WEINGARTNER Ear Forceps, alligator type, 3" (7.6 cm) shaft, concave serrated jaws
- 19-438 STRUEMPEL Ear Forceps, alligator type, 3" (7.6 cm) shaft, fenestrated oval spoon jaws
- 19-439 Duckbill Ear Forceps, alligator type, 3" (7.6 cm) shaft, very flat serrated jaws, rounded tip
- 19-442 HOFFMAN Ear Forceps, alligator type, 3" (7.6 cm) shaft, through cutting round jaws
- 19-464 BRUENING Ear Snare, bayonet shape, 2½" (6.4 cm), cannula, delicate pattern
- 19-465 Stylet only for Bruening Ear Snare
- 19-468 Cut Snare Wire, 3" (7.6 cm) long, fine size 1 for ear snares

For Snare Wire sizes 4 and 5 see page 294
 For Snare Wire sizes 6, 7, 8 and 9 see page 361



19-500



19-502



19-504



19-510



19-512

- 19-500 SEXTON Ear Knife 7" (17.8 cm), straight
- 19-502 SEXTON Ear Knife 7" (17.8 cm), bayonet
- 19-504 SEXTON Ear Knife 7" (17.8 cm), angled
- 19-510 POLITZER Ear Knife 7" (17.8 cm), spear blade, bayonet
- 19-512 POLITZER Ear Knife 7" (17.8 cm), spear blade, angled
- 19-520 SEXTON Ear Knife 7½" (19.1 cm), in reversible swivel handle (use in straight or angled position)
- 19-524 POLITZER Ear Knife 7½" (19.1 cm), in reversible swivel handle (use in straight or angled position)



19-520



19-524

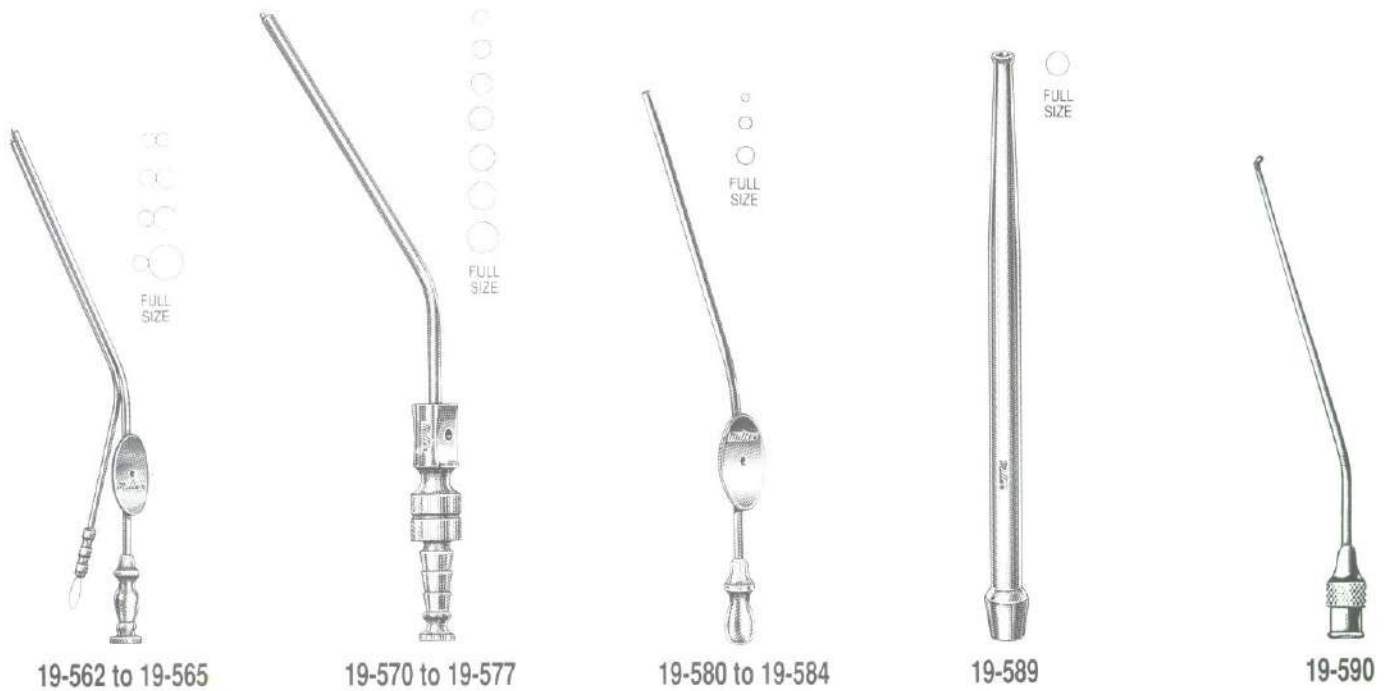

HOUSE SUCTION-IRRIGATION TUBES, 9 cm working length

- 19-562** 1.8 mm Suction Tube and 1.8 mm Irrigating Tube
- 19-563** 2.5 mm Suction Tube and 2 mm Irrigating Tube
- 19-564** 3 mm Suction Tube and 2 mm Irrigating Tube
- 19-565** 4.5 mm Suction Tube and 2 mm Irrigating Tube

FRAZIER FERGUSON SUCTION TUBES, with finger cut-off, angled

- | | | | |
|---------------|-------------------|---------------|--------------------|
| 19-570 | 6 French (2 mm) | 19-575 | 10 French (3.3 mm) |
| 19-572 | 7 French (2.3 mm) | 19-576 | 11 French (3.6 mm) |
| 19-573 | 8 French (2.6 mm) | 19-577 | 12 French (4 mm) |
| 19-574 | 9 French (3 mm) | | |

- 19-580** BARON Suction Tube, 3 French (1 mm) with finger cut-off, 7.5 cm tube
- 19-582** BARON Suction Tube, 5 French (1.7 mm) with finger cut-off, 7.5 cm tube
- 19-584** BARON Suction Tube, 7 French (2.3 mm) with finger cut-off, 7.5 cm tube
- 19-589** ANTHONY Suction Tube 6½" (16.5 cm), with 3 mm lumen
- 19-590** DAY Attic Cannula, 3" (7.6 cm) to bend, very delicate, tapered, with Luer Lock connection, silver



11-2

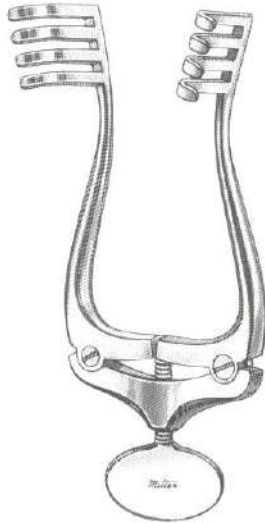

11-4

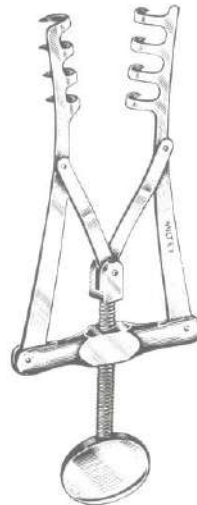

11-6

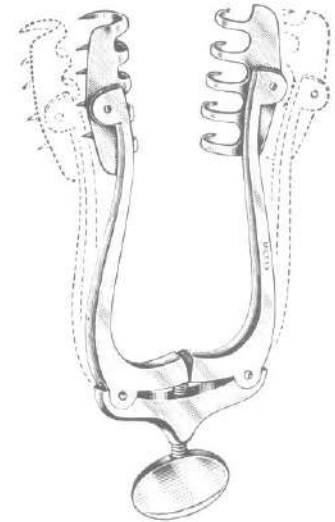

11-8

- 11-2 JANSEN Mastoid Retractor 4¼" (10.8 cm), spread 3" (7.6 cm), 3 x 3 blunt prongs
10 mm deep, standard model
- 11-4 JANSEN Mastoid Retractor 4½" (11.4 cm), spread 3" (7.6 cm), 4 x 4 blunt prongs
20 mm deep
- 11-6 ALLPORT Mastoid Retractor 4" (10.2 cm), spread 2½" (6.4 cm), 4 x 4 sharp prongs
- 11-8 JANSEN-WAGNER Mastoid Retractor 5" (12.7 cm), 5 x 5 sharp prongs, self-adjusting



11-10



11-12
11-13

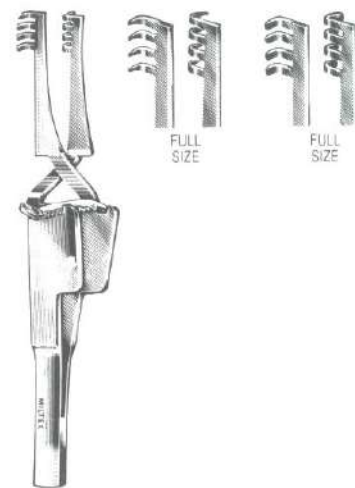

11-14
11-16

- 11-10 DAVIS Retractor 4½" (11.4 cm), 3 x 3 blunt prongs
- 11-12 ALM Retractor 2¾" (7 cm), spread 2¼" (5.7 cm), prongs ⅛" (.32 cm) deep
- 11-13 ALM Retractor 3⅞" (9.8 cm), spread 3" (7.6 cm), prongs ½" (1.3 cm) deep
- 11-14 MILTEX Cross Action Retractor 4" (10.2 cm), sharp prongs
- 11-16 MILTEX Cross Action Retractor 4" (10.2 cm), blunt prongs

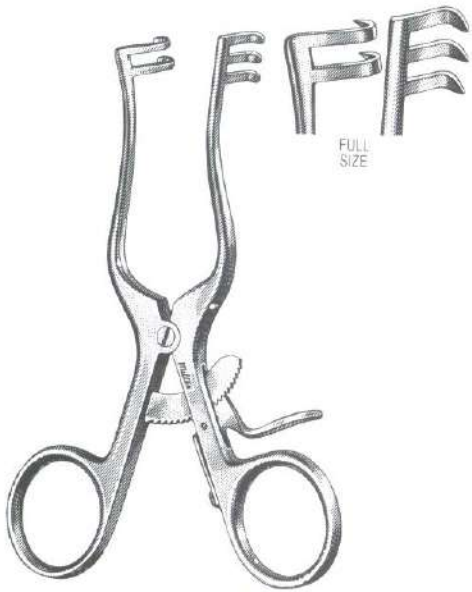

11-600 to 11-602

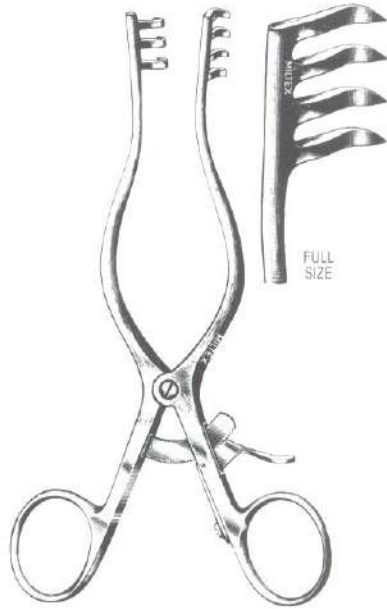

11-608 to 11-616

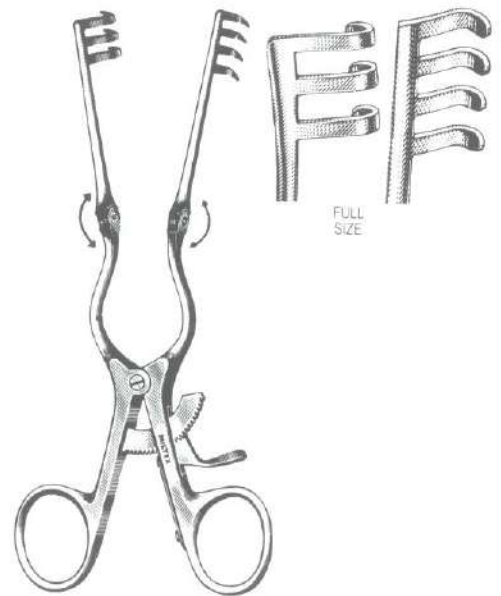

11-630 to 11-634

WEITLANER RETRACTORS

Sharp		Blunt
11-600	4" (10.2 cm), 2 x 3 teeth	11-602
11-608	5½" (14 cm), 3 x 4 teeth	11-610
11-614	6½" (16.5 cm), 3 x 4 teeth	11-616

BECKMAN-WEITLANER RETRACTORS, with hinged blades

Sharp		Blunt
11-630-SH	5½" (14 cm), 3 x 4 teeth	11-630-BL
11-634-SH	6½" (16.5 cm), 3 x 4 teeth	11-634-BL

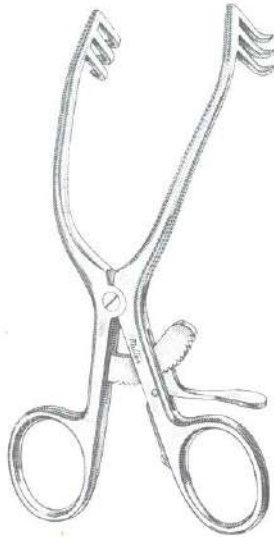

19-655



19-660

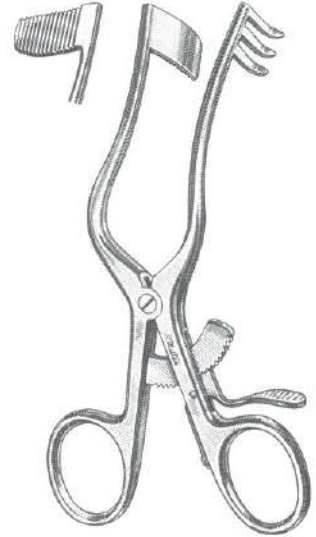

19-668
19-669

- 19-655 SCHUHKNECHT Postauricular Retractor 5" (12.7 cm), 3 x 3 sharp teeth 3" (7.6 cm) opening
- 19-660 WULLSTEIN Endaural Retractor 5" (12.7 cm), 3 x 3 sharp teeth, ebony non-glare finish
- 19-668 PERKINS Endaural Retractor 5¼" (13.3 cm), left serrated solid blade, right side 3 teeth
- 19-669 PERKINS Endaural Retractor 5¼" (13.3 cm), right serrated solid blade, left side 3 teeth



19-700 to 19-720



19-750 to 19-760



19-770 to 19-780



19-784
19-785



19-790

- | | |
|---|----------|
| SPRATT (BRUN) MASTOID CURETTES 6½" (16.5 cm), oval cups | |
| 19-700 | Size 5/0 |
| 19-702 | Size 4/0 |
| 19-704 | Size 3/0 |
| 19-706 | Size 2/0 |
| 19-708 | Size 0 |
| 19-710 | Size 1 |
| 19-712 | Size 2 |
| 19-714 | Size 3 |
| 19-716 | Size 4 |
| 19-718 | Size 5 |
| 19-720 | Size 6 |
-
- | | |
|--------|---|
| 19-750 | ALEXANDER Mastoid Chisel 7" (17.8 cm), width 4 mm |
| 19-752 | ALEXANDER Mastoid Chisel 7" (17.8 cm), width 6 mm |
| 19-754 | ALEXANDER Mastoid Chisel 7" (17.8 cm), width 8 mm |
| 19-756 | ALEXANDER Mastoid Chisel 7" (17.8 cm), width 10 mm |
| 19-758 | ALEXANDER Mastoid Chisel 7" (17.8 cm), width 12 mm |
| 19-760 | ALEXANDER Mastoid Chisel 7" (17.8 cm), width 14 mm |
| 19-770 | ALEXANDER Mastoid Gouge 7" (17.8 cm), width 4 mm |
| 19-772 | ALEXANDER Mastoid Gouge 7" (17.8 cm), width 6 mm |
| 19-774 | ALEXANDER Mastoid Gouge 7" (17.8 cm), width 8 mm |
| 19-776 | ALEXANDER Mastoid Gouge 7" (17.8 cm), width 10 mm |
| 19-780 | ALEXANDER Mastoid Gouge 7" (17.8 cm), width 14 mm |
| 19-784 | BISHOP Mastoid Gouge 6¾" (17.1 cm), width 3 mm |
| 19-785 | BISHOP Mastoid Gouge 6¾" (17.1 cm), width 4 mm |
| 19-790 | GERZOG Mallet 7½" (19.1 cm), head 8 oz. (227 g) lead filled with stainless jacket |
| 19-792 | LUCAE Mallet 7¾" (19.7 cm), head 9 oz. (255 g) solid stainless |

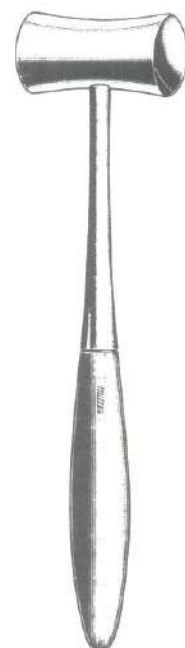

19-792

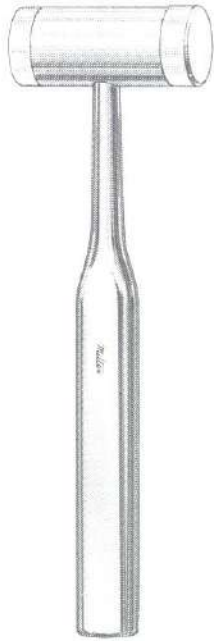

19-793
19-794

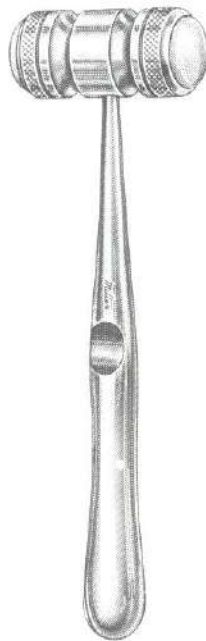

19-796

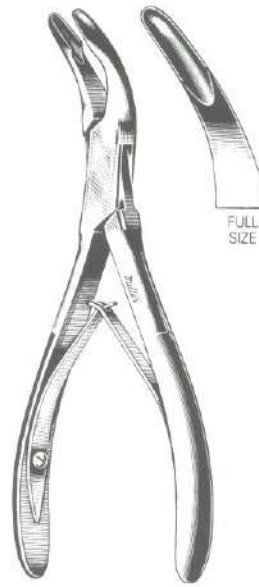

19-804

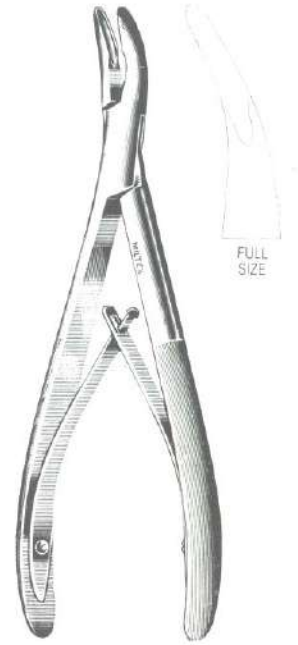

19-808



18-1990 to 18-1996

- 19-793 MILTEX Mallet 7½" (19.1 cm), lightweight 7.5 oz. (213 g), stainless head 1" (2.5 cm) dia. with 2 replaceable nylon caps
- 19-794 MILTEX Mallet 7½" (19.1 cm), lightweight 9 oz. (255 g), stainless head 1" (2.5 cm) dia. with one stainless face and one replaceable nylon cap
- 19-795 Nylon Cap Replacement for Nos. 19-793 and 19-794 Mallets
- 19-796 MEAD Mallet 7½" (19.1 cm), head 8 oz. (227 g), with 2 replaceable nylon caps
- 19-797 Nylon Cap Replacement for No. 19-796 Mallet
- 19-804 HARTMAN Mastoid Rongeur 5¾" (14.6 cm), strong curve
- 19-808 BANE Mastoid Rongeur 7" (17.8 cm), curved
- 18-1990 KERRISON Rongeur 3" (7.6 cm) shaft, size 0, 3.5 mm bite
- 18-1992 KERRISON Rongeur 3" (7.6 cm) shaft, size 1, 4 mm bite
- 18-1994 KERRISON Rongeur 3" (7.6 cm) shaft, size 2, 4.5 mm bite
- 18-1996 KERRISON Rongeur 3" (7.6 cm) shaft, size 3, 5 mm bite



19-840

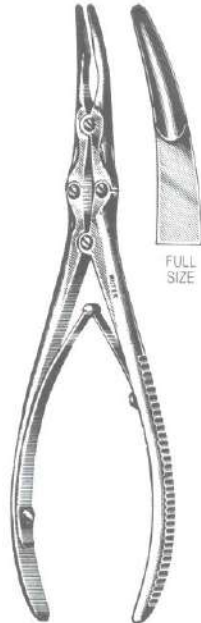

19-844

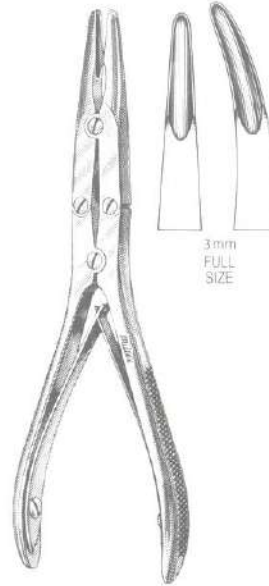

19-848
19-849

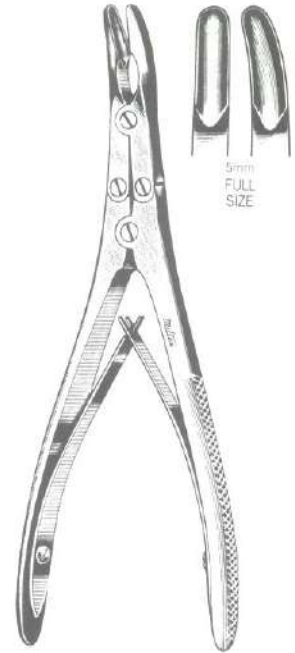

19-850 to 19-856

19-840 ZAUFEL-JANSEN Rongeur 7" (17.8 cm), double action, slightly curved jaws 5 mm wide

19-844 BEYER Rongeur 7" (17.8 cm), double action, slightly curved jaws 3.5 mm wide

RUSKIN RONGEURS, double action

Straight Jaws

Curved Jaws

19-848	6" (15.2 cm) long, 3 mm bite	19-849
19-850	7 1/4" (18.4 cm) long, 5 mm bite	19-852
19-854	7 1/4" (18.4 cm) long, 7 mm bite	19-856

19-1230 LEMPert Rongeur 6 1/4" (15.9 cm), straight, delicate, 2.5 mm bite

19-1232 LEMPert Rongeur 6 1/4" (15.9 cm), curved, delicate, 2.5 mm bite

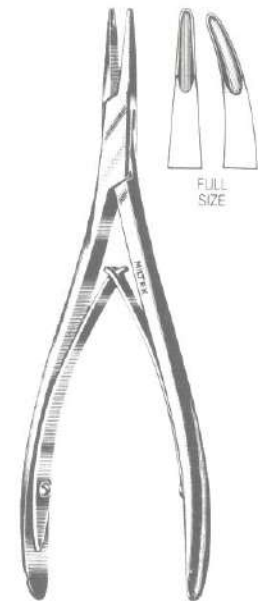

19-1230
19-1232



19-1234

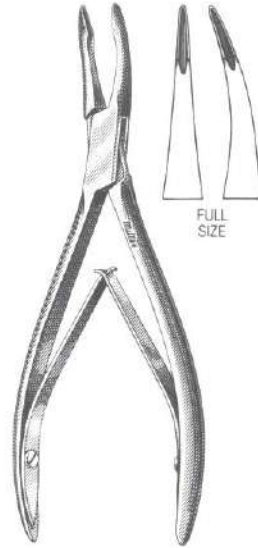

17-4800
17-4801



19-1330



19-1334
19-1336



19-1340

- 19-1234 JUERS-LEMPERT Rongeur 7¼" (18.4 cm), straight jaws on curved handles, delicate, 2.5 mm bite
- 17-4800 Micro Friedman Rongeur 5½" (14 cm), straight 1.3 mm wide jaws, very delicate
- 17-4801 Micro Friedman Rongeur 5½" (14 cm), curved 1.3 mm wide jaws, very delicate
- 19-1330 LEMPERT Elevator 7¼" (18.4 cm), straight 2 mm blade, light pattern
- 19-1334 LEMPERT Elevator 7¼" (18.4 cm), curved 2 mm blade, light pattern
- 19-1336 LEMPERT Elevator 7¼" (18.4 cm), curved 3 mm blade, light pattern
- 19-1340 LEMPERT Elevator 7¼" (18.4 cm), curved 4 mm blade, heavy pattern
- 19-1350 LEMPERT Endaural Curette 8¼" (21 cm), oval cup size 5/0
- 19-1352 LEMPERT Endaural Curette 8¼" (21 cm), oval cup size 4/0
- 19-1354 LEMPERT Endaural Curette 8¼" (21 cm), oval cup size 3/0
- 19-1356 LEMPERT Endaural Curette 8¼" (21 cm), oval cup size 2/0
- 19-1820 Ear Suction Tube, with 2 interchangeable tips 20 ga. and 22 ga.



19-1350 to 19-1356



19-1820

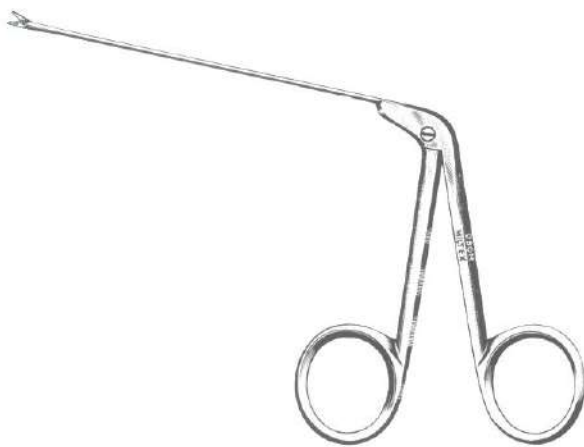

19-2060

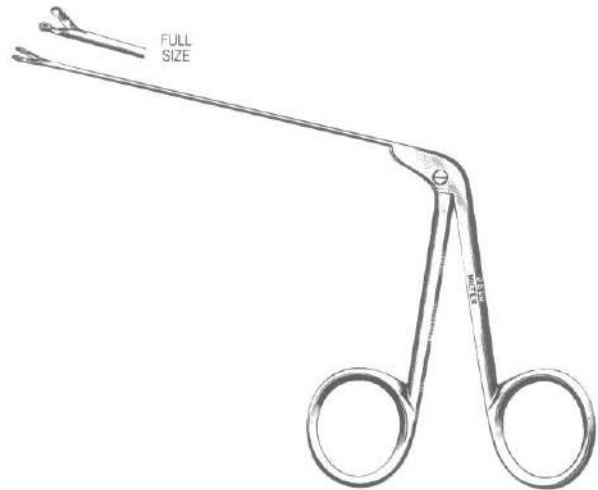

19-2120
19-2130

- 19-2060 WULLSTEIN Ear Scissors, 3" (7.6 cm) shaft, straight, very delicate
- 19-2120 WULLSTEIN Ear Forceps 3" (7.6 cm) shaft, oval cup jaws 1 mm wide
- 19-2130 WULLSTEIN Ear Forceps 3" (7.6 cm) shaft, round cup jaws 1 mm dia.
- 19-2081-B Micro Alligator Ear Forceps 3¼" (8.3 cm) shaft, serrated jaws 0.6 mm wide, ebony finish
- 19-2100 Micro Alligator Ear Forceps, 3¼" (8.3 cm) shaft, serrated jaws 0.8 mm wide
- 19-2100-B Micro Alligator Ear Forceps, 3¼" (8.3 cm) shaft, serrated jaws 0.8 mm wide, ebony finish
- 19-2090-B Micro Alligator Ear Forceps, 3¼" (8.3 cm) shaft, oval cup jaws 0.5 mm wide, ebony finish
- 19-2110 Micro Alligator Ear Forceps, 3¼" (8.3 cm) shaft, oval cup jaws 0.8 mm wide
- 19-2110-B Micro Alligator Ear Forceps, 3¼" (8.3 cm) shaft, oval cup jaws 0.8 mm wide, ebony finish
- 19-2138 HOUSE Strut Forceps, 2¾" (7 cm) shaft, smooth jaws 0.8 mm wide
- 19-2150-B BELLUCCI Micro Ear Scissors, 2¾" (7 cm) shaft, 4 mm blades, ebony finish

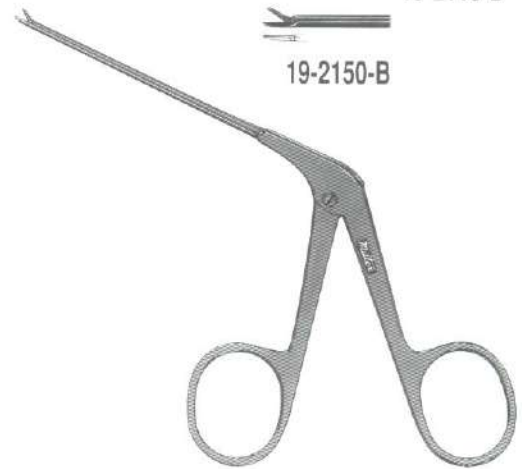
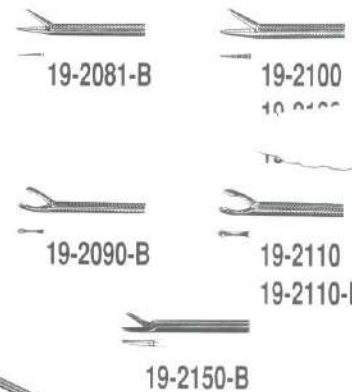

19-2081-B to 19-2150-B

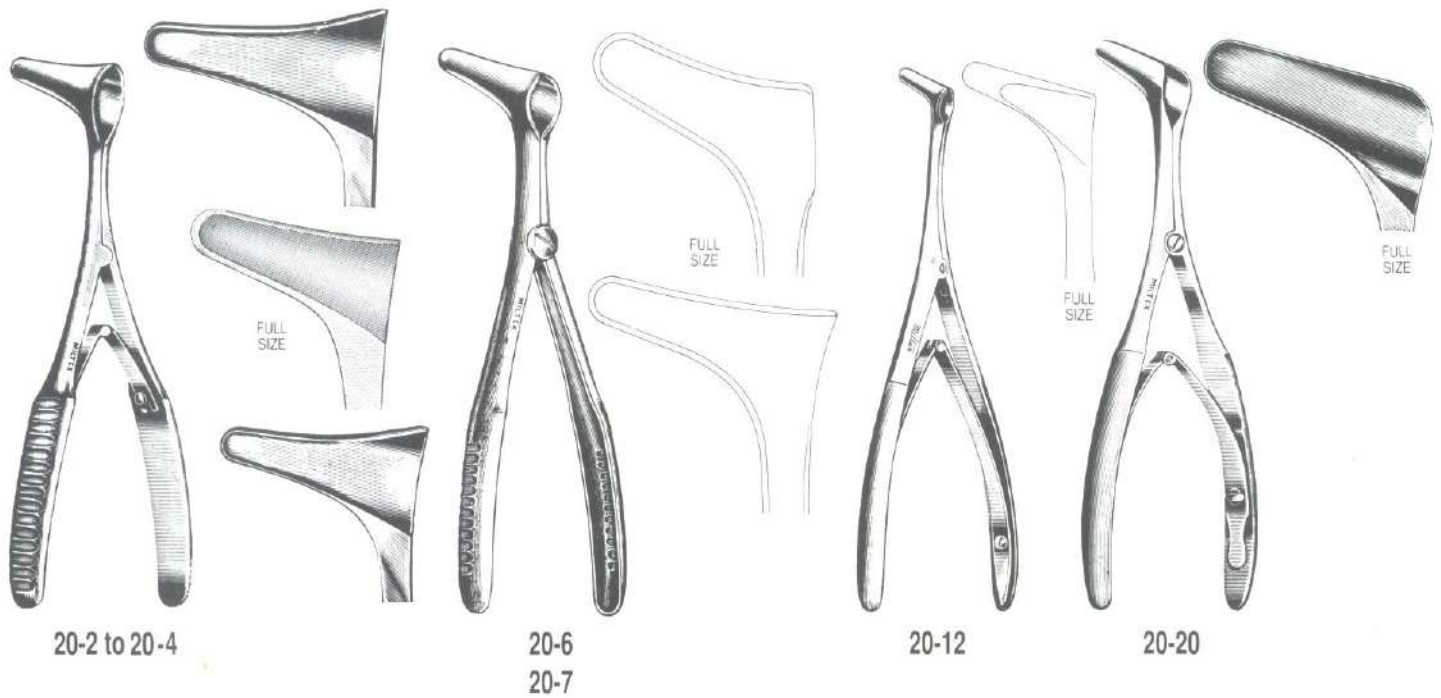

- 20-2 VIENNA Nasal Speculum 5¾" (14.6 cm), standard pattern, large size
- 20-3 VIENNA Nasal Speculum 5¾" (14.6 cm), standard pattern, medium size
- 20-4 VIENNA Nasal Speculum 5¾" (14.6 cm), standard pattern, small size
- 20-6 VIENNA Lightweight Nasal Speculum 5¾" (14.6 cm), adult size
- 20-7 VIENNA Lightweight Nasal Speculum 5¾" (14.6 cm), child size
- 20-12 TIECK (HALLE) Infant Nasal Speculum 5¾" (14 cm)
- 20-20 SONNENSCHNAIN Nasal Speculum 6" (15.2 cm)
- 20-24 BECKMAN Nasal Speculum 6" (15.2 cm), angled on side

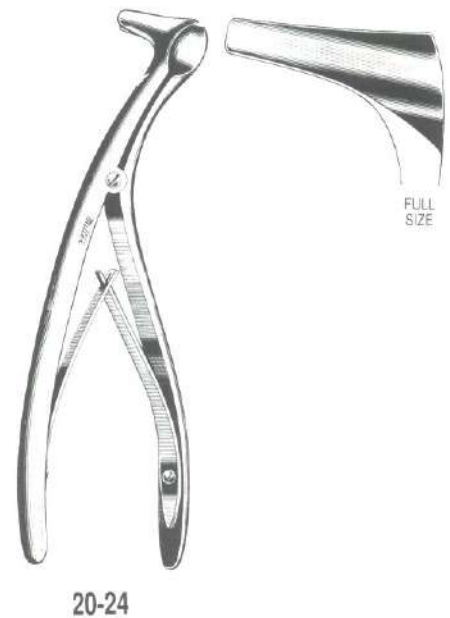



20-28 to 20-32



20-36-35 to 20-36-90

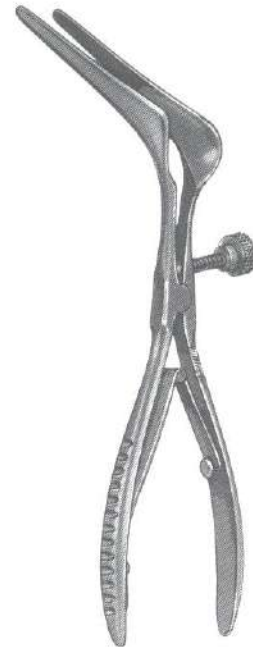

20-37-45 to 20-37-75

- 20-28** KILLIAN Septum Speculum 6" (15.2 cm), with set screw, 2" (5.1 cm) long blades
- 20-29** KILLIAN Septum Speculum 6" (15.2 cm), with set screw, 2½" (6.4 cm) long blades
- 20-30** KILLIAN Septum Speculum 6" (15.2 cm), with set screw, 3" (7.6 cm) long blades
- 20-32** KILLIAN Septum Speculum 6" (15.2 cm), with set screw, 3½" (8.9 cm) long blades
- 20-36-35** COTTLE Septum Speculum 6" (15.2 cm), with set screw, narrow 35 mm long blades, ebony finish
- 20-36-50** COTTLE Septum Speculum 6" (15.2 cm), with set screw, narrow 50 mm long blades, ebony finish
- 20-36-75** COTTLE Septum Speculum 6" (15.2 cm), with set screw, narrow 75 mm long blades, ebony finish
- 20-36-90** COTTLE Septum Speculum 6" (15.2 cm), with set screw, narrow 90 mm long blades, ebony finish
- 20-37-45** COTTLE Septum Speculum 5½" (14 cm), with set screw, extra delicate, very thin 45 mm long blades, ebony finish
- 20-37-75** COTTLE Septum Speculum 5½" (14 cm), with set screw, extra delicate, very thin 75 mm long blades, ebony finish

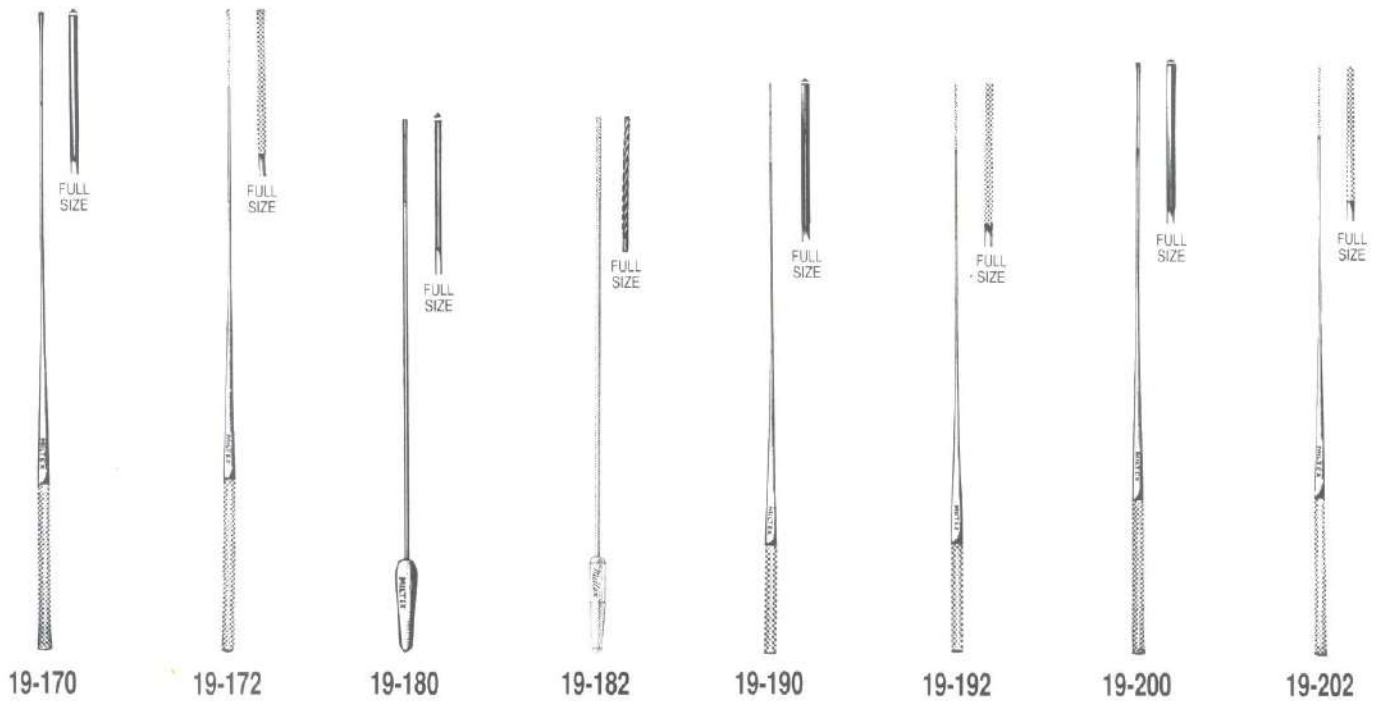

- 19-170 UEBE Applicator 7" (17.8 cm), triangular tip
- 19-172 UEBE Applicator 7" (17.8 cm), cross serrated tip
- 19-180 BROWN Applicator 6" (15.2 cm), triangular tip, copper
- 19-182 BROWN Applicator 6" (15.2 cm), cross serrated tip, copper
- 19-190 LATHBURY Applicator 5½" (14 cm), triangular tip
- 19-192 LATHBURY Applicator 5½" (14 cm), cross serrated tip
- 19-200 FARRELL Applicator 6½" (16.5 cm), triangular tip
- 19-202 FARRELL Applicator 6½" (16.5 cm), cross serrated tip
- 20-100 THEOBALD (FISH) Sinus Probe 6" (15.2 cm), sterling
- 20-102 SKILLERN Sinus Probe 6½" (16.5 cm), graduated, sterling
- 20-120 WILDE Nasal Dressing Forceps 6½" (16.5 cm), angular





6-190



6-192



19-371



6-197
6-198

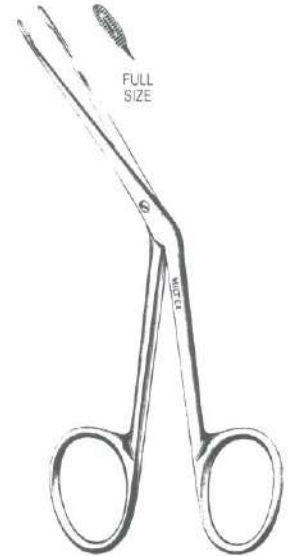

20-124

- 6-190 CUSHING Dressing Forceps 7¼" (18.4 cm), bayonet, serrated tips, scraper end
- 6-192 CUSHING Tissue Forceps 7¼" (18.4 cm), bayonet, 1 x 2 teeth, scraper end
- 19-371 JANSEN Bayonet Dressing Forceps 6¼" (15.9 cm), extra delicate with 2 mm wide serrated tips
- 6-197 JANSEN (GRUENWALD) Bayonet Dressing Forceps 6¼" (15.9 cm), serrated tips
- 6-198 ADSON Bayonet Dressing Forceps 8¼" (21 cm), serrated tips
- 20-124 HARTMAN Nasal Dressing Forceps 7" (17.8 cm), improved delicate pattern, serrated tips
- 20-126 HARTMAN Nasal Dressing Forceps 7¼" (18.4 cm), regular model, serrated tips
- 20-130 LITTAUER Nasal Dressing Forceps 6¾" (17.1 cm), slender mortised shanks, serrated tips



20-126

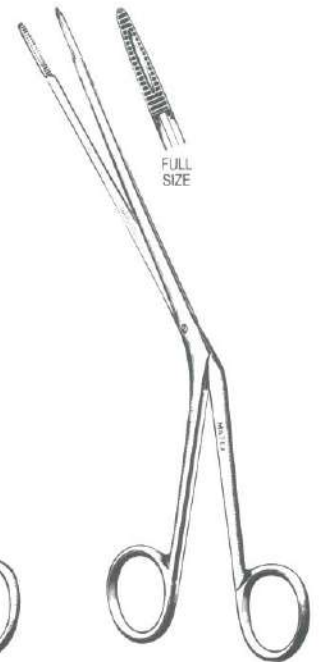

20-130

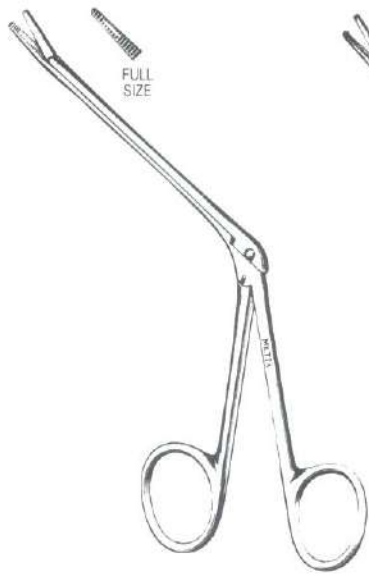

20-140
20-142

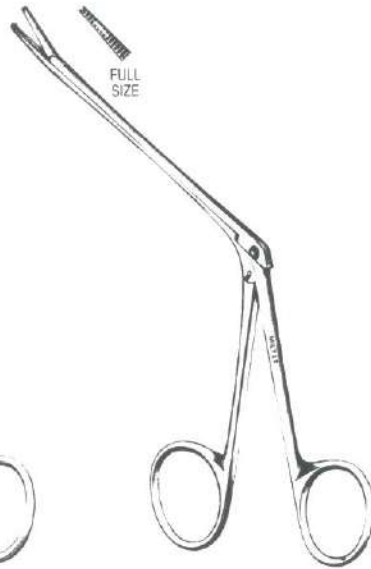

20-144

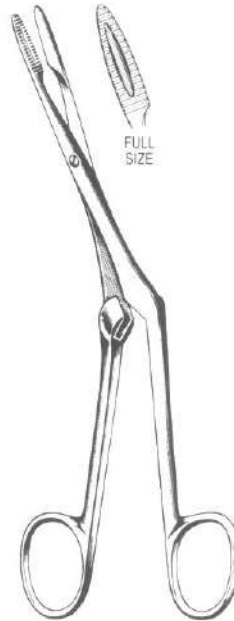

20-148

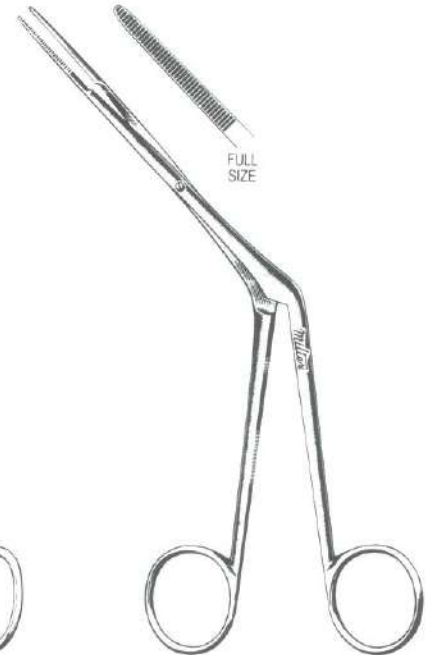

20-150

- 20-140 NOYES Alligator Forceps 5½" (14 cm) shaft, serrated jaws
- 20-142 NOYES Alligator Forceps 6½" (16.5 cm) shaft, serrated jaws
- 20-144 NOYES Alligator Forceps 5½" (14 cm) shaft, 1 x 2 teeth
- 20-148 KNIGHT Nasal Forceps 6¾" (17.1 cm), standard pattern, serrated tips
- 20-150 MUSEHOLDT Nasal Dressing Forceps 7" (17.8 cm), slender long serrated blades



20-160



20-164



20-168



20-177

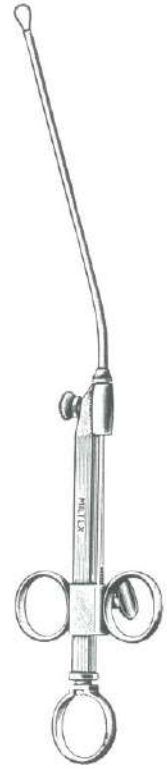

20-180

- 20-160** KNIGHT Nasal Scissors 6³/₄" (17.1 cm), angled on side, standard pattern
- 20-164** HEYMAN Nasal Scissors 6³/₄" (17.1 cm), angled on side, rounded blades
- 20-168** SEILER Turbinate Scissors 6¹/₄" (15.9 cm), angled on side
- 20-177** BRUENING Nasal Snare 9" (22.9 cm), bayonet shape for unobstructed view
- 20-178** Stylet only for Bruening Snare
- 20-180** KRAUSE Nasal Snare 10" (25.4 cm), standard pattern with slightly angled cannula
- 20-182** Stylet only for Krause Snare
- 20-184** Cannula only for Krause Snare
- 20-186-4*** Cut Snare Wire, 4" (10.2 cm) long with formed ends, size 4, for nasal snares
- 20-186-5*** Cut Snare Wire, 4" (10.2 cm) long with formed ends, size 5, for nasal snares



20-186

*For Snare Wire size 1 see page 277

*For Snare Wire sizes 6, 7, 8 and 9 see page 361

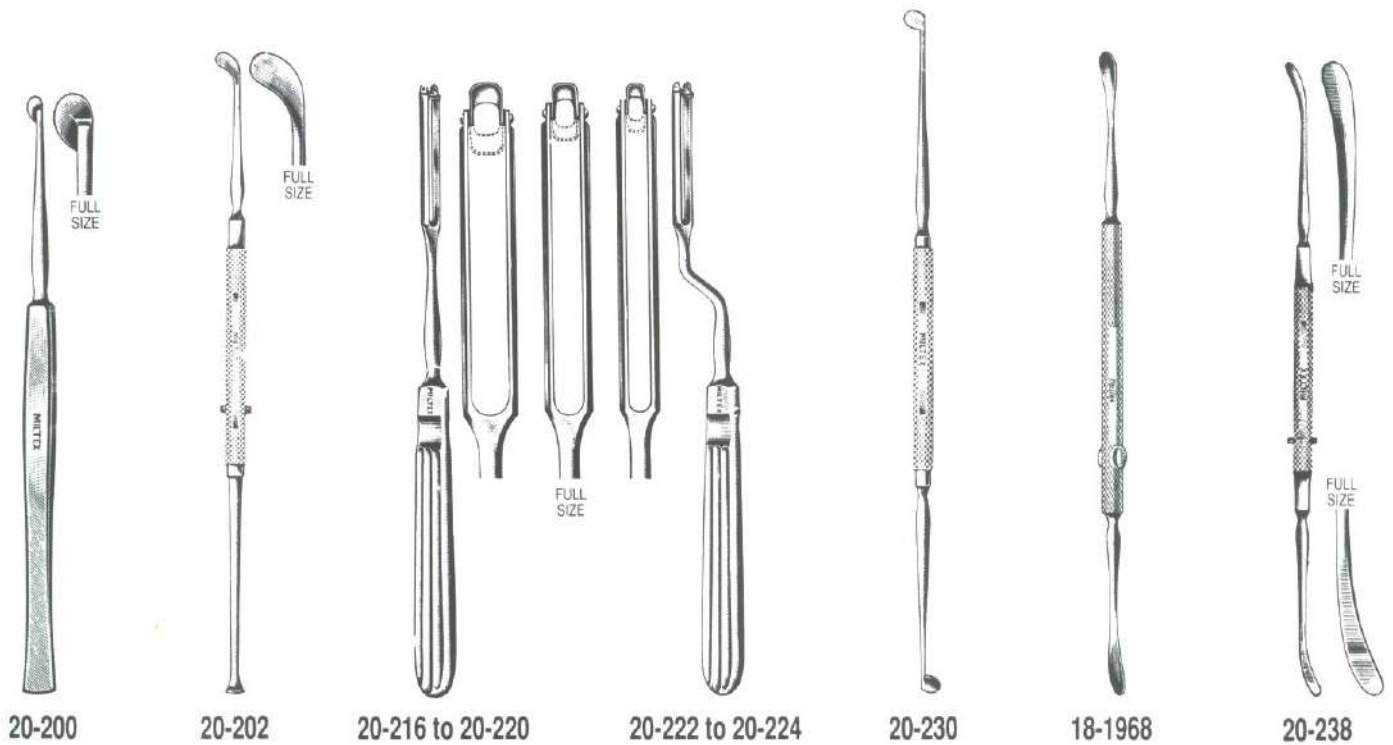

20-200 FREER Septum Knife 6¼" (15.9 cm), "D" model blade
20-202 FREER Submucous Knife 7½" (19.1 cm), angled blade

BALLENGER SWIVEL KNIVES 7¾" (19.7 cm)

Straight	Width	Bayonet
20-216	3 mm	20-222
20-218	4 mm	20-224
20-220	5 mm	—

20-230 PIERCE Double End Elevator 8½" (21.6 cm), with right and left blades

18-1968 FREER Elevator 7" (17.8 cm), double end sharp and blunt blades 5 mm wide

20-238 ROGER Septum Elevator 7¾" (19.7 cm), double ended with curved semi-sharp and blunt blades



- 20-242** DUNNING Elevator and Curette 8¼" (21 cm), blunt elevator and sharp small oval curette
- 20-246** PENNINGTON Septum Elevator 8¼" (21 cm), double end for right and left side
- 20-258** HAJEK-BALLENGER Septum Elevator 7¼" (18.4 cm), double end straight semi-sharp and blunt blades
- 20-270** FREER Submucous Chisel 6½" (16.5 cm), straight, 4 mm wide
- 18-1960** FREER Submucous Chisel 6½" (16.5 cm), curved, 4 mm wide
- 20-274** FREER Septum Gouge 6¼" (15.9 cm), straight, 6 mm wide
- 20-278** BALLENGER V-Shaped Chisel 6¼" (15.9 cm), 2 mm wide
- 20-280** BALLENGER V-Shaped Chisel 6¼" (15.9 cm), 4 mm wide
- 20-282** BALLENGER V-Shaped Chisel 6¼" (15.9 cm), 6 mm wide
- 20-284** BALLENGER V-Shaped Chisel 6¼" (15.9 cm), 8 mm wide



20-300



20-308



20-312



20-330 to 20-342



20-360

20-300 HALLÉ Ethmoid Curette 8½" (21.6 cm), stainless oval cup on malleable copper shaft

20-308 MOSHER Ethmoid Curette 8¾" (22.2 cm), double end oval cups, shaft graduated in ½ inches (1.3 cm)

20-312 PRATT Ethmoid Curette 8¼" (21.6 cm), double end, fenestrated cup on angled shaft and solid cup on straight shaft

COAKLEY ANTRUM CURETTES 6¾" (17.1 cm)

20-330 Set of 6, Nos. 1 through 6

20-332 No. 1 Large Size 30° angle

20-334 No. 2 Large Size 60° angle

20-336 No. 3 Large Size 100° angle

20-338 No. 4 Small Size 30° angle

20-340 No. 5 Small Size 60° angle

20-342 No. 6 Triangle 30° angle

20-360 FAULKNER Ethmoid Curette 9" (22.9 cm), double end 7 mm and 10 mm rings, sharp on both sides

20-378 WIENER Antrum Rasp 8" (20.3 cm), No. 1 small with trocar tip

20-380 WIENER Antrum Rasp 8" (20.3 cm), No. 2 medium with trocar tip

20-382 WIENER Antrum Rasp 8" (20.3 cm), No. 3 large with trocar tip

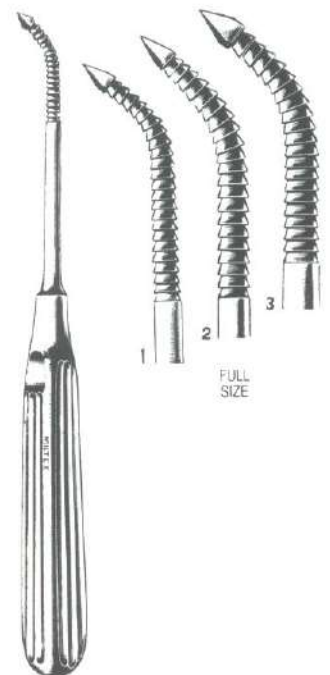

20-378 to 20-382

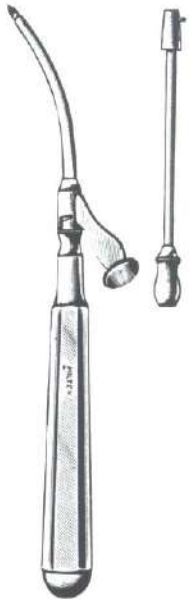

20-400



20-404



20-420



20-424



20-428



20-430

- 20-400 COAKLEY Antrum Trocar 7" (17.8 cm), standard curve with 3 mm dia. cannula and irrigating extension
- 20-404 PIERCE Antrum Trocar 7" (17.8 cm), with 5 mm dia. cannula and tubing connection
- 20-420 LICHTWICZ Antrum Trocar Needle 4½" (11.4 cm), 16 gauge with beveled stylet and crossbar, Luer lock
- 20-424 VAN ALYEA Antrum Cannula 4½" (11.4 cm), trocar tip 1.8 mm, Luer lock
- 20-428 RUSKIN Antrum Trocar Needle 4" (10.2 cm), straight, 16 gauge with cross bar and tubing connection, Luer lock
- 20-430 RUSKIN Antrum Trocar Needle, 4" (10.2 cm), curved, 16 gauge with cross bar and tubing connection, Luer lock
- 20-436 VAN ALYEA Frontal Sinus Cannula 6½" (16.5 cm), light curve, with tubing connection, Luer lock, sterling
- 20-438 VAN ALYEA Frontal Sinus Cannula 6½" (16.5 cm), strong curve, with tubing connection, Luer lock, sterling



20-436



20-438

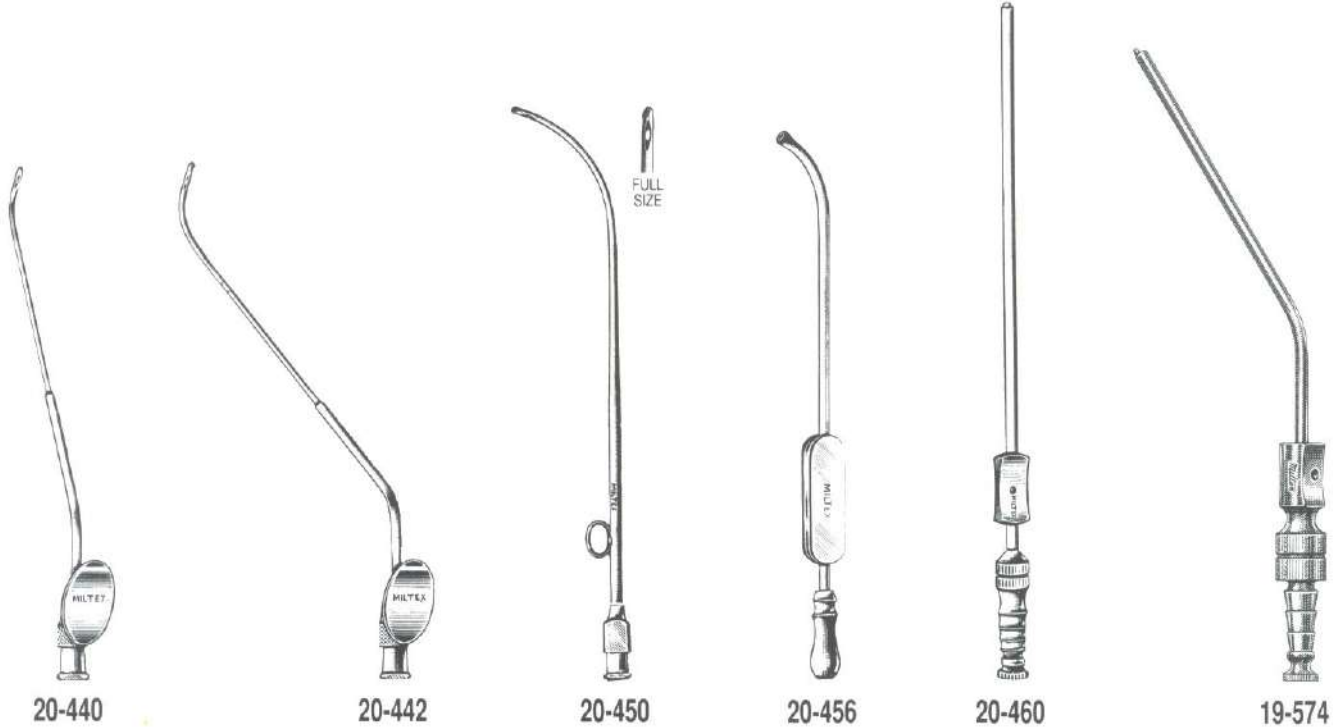

- 20-440** VAN ALYEA Antrum Cannula 4½" (11.4 cm), long curve, blunt tip, 1.8 mm, Luer lock
- 20-442** VAN ALYEA Frontal Cannula 4½" (11.4 cm), short curve, blunt tip, 1.8 mm, Luer lock
- 20-450** BOWER Sphenoid and Antrum Cannula 6½" (16.5 cm), dia. at tip 2 mm, lateral opening, Luer lock
- 20-456** KILLIAN (VON EICKEN) Antrum Cannula 5¾" (14.6 cm), dia. 2.5 mm, bulbous tip, center opening, sterling
- 20-460** FRAZIER FERGUSON Suction Tube 9 Fr. (3 mm) straight, with finger cut-off
- 19-574** FRAZIER FERGUSON Suction Tube 9 Fr. (3 mm) angled, with finger cut-off
- 20-466** COUPLAND Suction Tube 10" (25.4 cm), with 2 interchangeable tips 1.5 and 2 mm, chrome
- 10-220** ANTHONY Suction Tube 10" (25.4 cm), lumen 2 mm, chrome

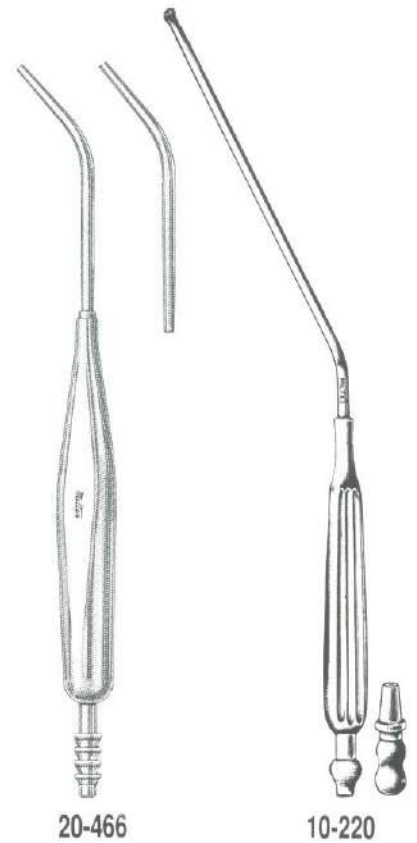



20-500

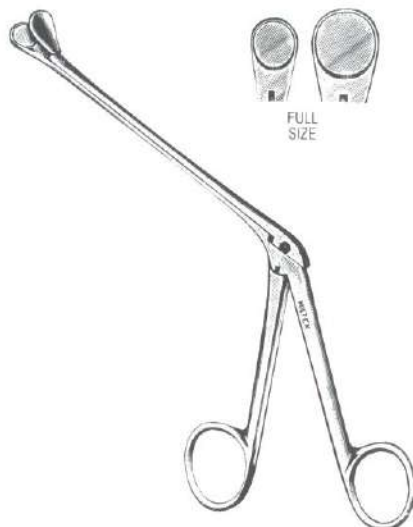

20-504
20-506

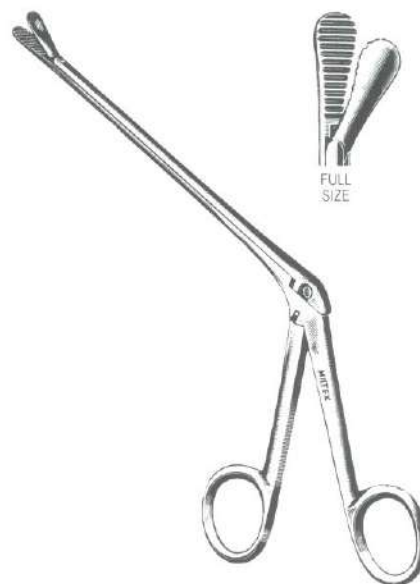

20-510

- 20-500 KILLIAN Septum Forceps 6¾" (17.1 cm), flat serrated jaws 25 x 5.5 mm, shaft 3¼" (8.3 cm)
- 20-504 WATSON-WILLIAMS Polyp Forceps 7¾" (19.7 cm), small jaws 6 mm wide, shaft 4¼" (10.8 cm)
- 20-506 WATSON-WILLIAMS Polyp Forceps 7¾" (19.7 cm), large jaws 9 mm wide, shaft 4¼" (10.8 cm)
- 20-510 LEWIS Septum Forceps 8" (20.3 cm), flat serrated jaws, 15 x 7 mm, shaft 4¾" (12.1 cm)
- 20-522 KNIGHT Septum Forceps 6¾" (17.1 cm), cup jaws 15 x 5 mm, shaft 3¼" (8.3 cm)

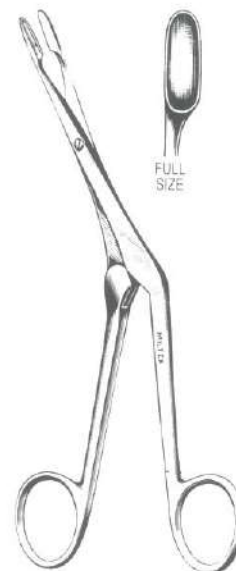

20-522



20-530
20-532



20-544
20-546

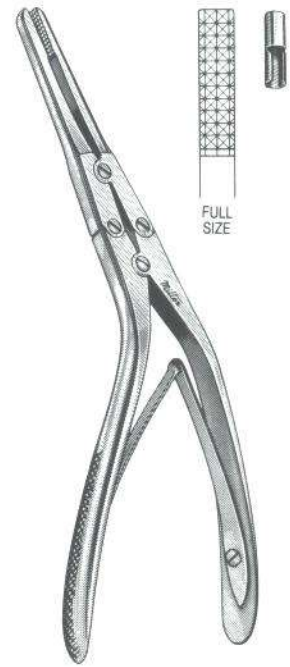

20-552
20-553

- 20-530 LUC Septum Forceps 7³/₄" (19.7 cm), cup jaws 9 x 5.5 mm
- 20-532 LUC Septum Forceps 7³/₄" (19.7 cm), cup jaws 11 x 6.5 mm
- 20-544 BRUENING Septum Forceps 7¹/₂" (19.1 cm), mortised shanks, small fenestrated cup jaws 7 mm wide
- 20-546 BRUENING Septum Forceps 7¹/₂" (19.1 cm), mortised shanks, large fenestrated cup jaws 8 mm wide
- 20-552 RUBIN Septal Morselizer 8" (20.3 cm), double action, deeply serrated jaws 17 x 5 mm, supplied with one slip-on guard
- 20-553 Slip-on guard only

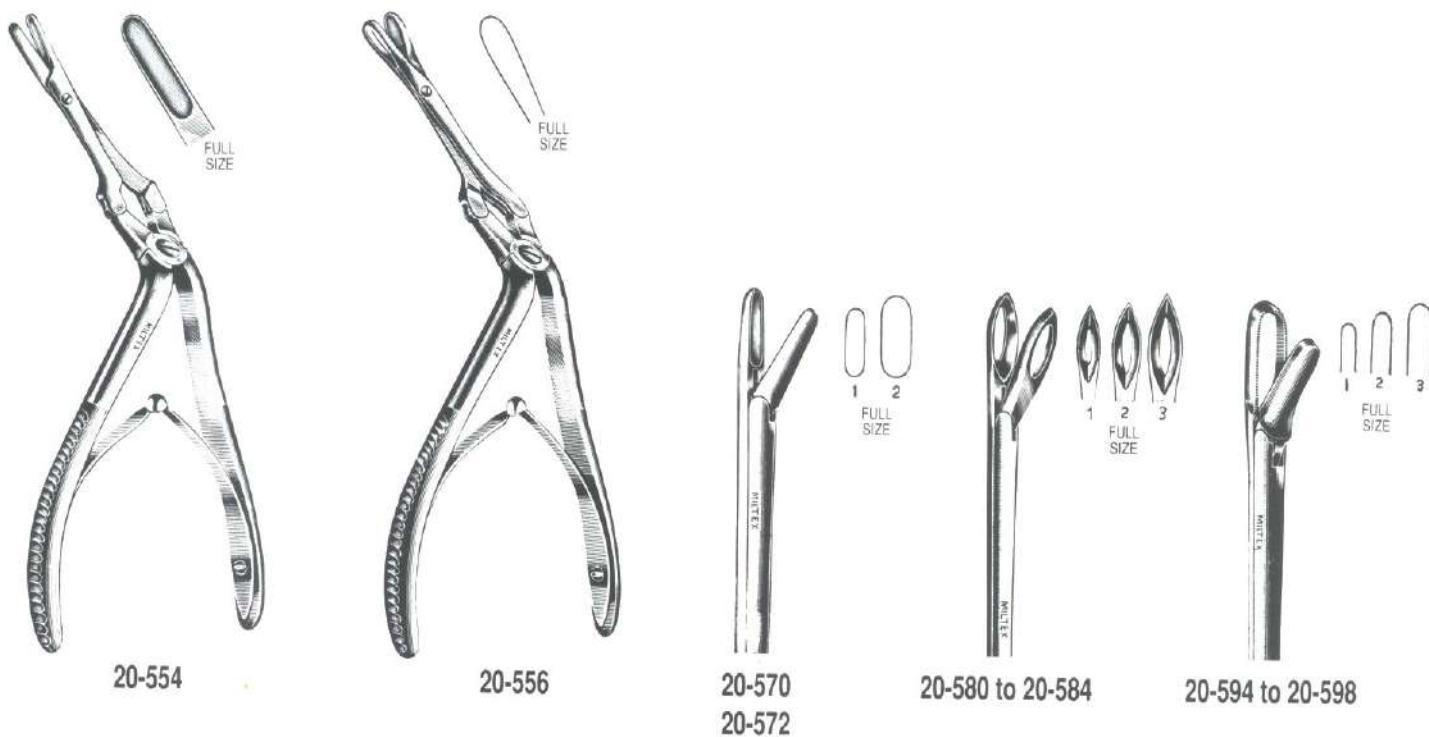

- 20-554** JANSEN-MIDDLETON Septum Forceps 7½" (19.1-cm), spoon-shaped cups 15 x 5 mm
- 20-556** JANSEN-MIDDLETON Septum Forceps 7½" (19.1 cm), through-cutting 19 x 4 mm
- 20-570** TAKAHASHI Ethmoid Forceps, 4½" (11.4 cm) shaft, 2.5 x 10 mm bite
- 20-572** TAKAHASHI Ethmoid Forceps, 4½" (11.4 cm) shaft, 4 x 10 mm bite
- 20-580** WILDE (BLAKESLEY) Ethmoid Forceps 5" (12.7 cm) shaft, pointed fenestrated cups 3 x 11 mm
- 20-582** WILDE (BLAKESLEY) Ethmoid Forceps 5" (12.7 cm) shaft, pointed fenestrated cups 4 x 12 mm
- 20-584** WILDE (BLAKESLEY) Ethmoid Forceps 5" (12.7 cm) shaft, pointed fenestrated cups 5 x 13 mm
- 20-594** GRUENWALD Nasal Forceps, 4½" (11.4 cm) shaft, through-cutting 2 x 10 mm bite
- 20-596** GRUENWALD Nasal Forceps, 4½" (11.4 cm) shaft, through-cutting 2.5 x 12 mm bite
- 20-598** GRUENWALD Nasal Forceps, 4½" (11.4 cm) shaft, through-cutting 3 x 12 mm bite
- 20-630** STRUYKEN Turbinate Forceps, 4½" (11.4 cm) shaft, through-cutting 1 x 15 mm bite

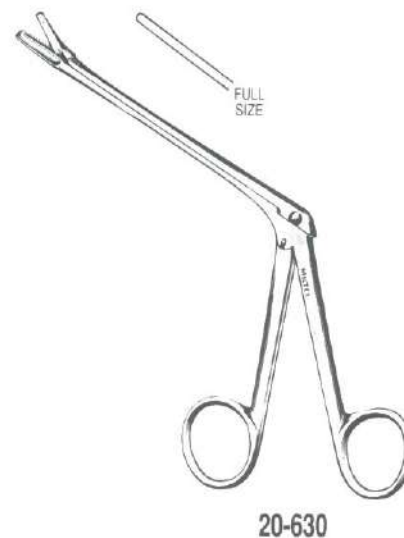



18-1990 to 18-1996

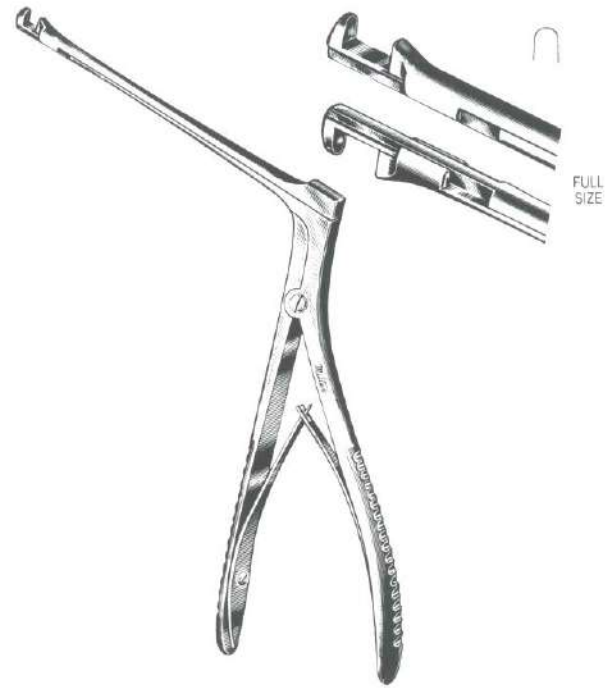

20-660
20-662

- | | |
|---------|--|
| 18-1990 | KERRISON Rongeur, 3" (7.6 cm) shaft, size 0, 3.5 mm bite |
| 18-1992 | KERRISON Rongeur, 3" (7.6 cm) shaft, size 1, 4 mm bite |
| 18-1994 | KERRISON Rongeur, 3" (7.6 cm) shaft, size 2, 4.5 mm bite |
| 18-1996 | KERRISON Rongeur, 3" (7.6 cm) shaft, size 3, 5 mm bite |
| 20-660 | HAJEK Antrum Rongeur, 5" (12.7 cm) shaft, up-bite |
| 20-662 | HAJEK Antrum Rongeur, 5" (12.7 cm) shaft, down-bite |

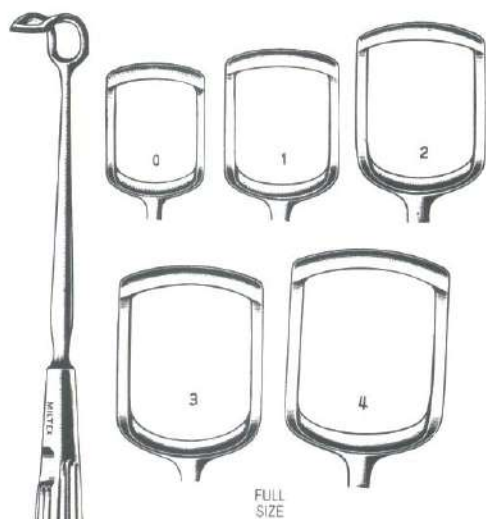

20-800 to 20-808



20-809

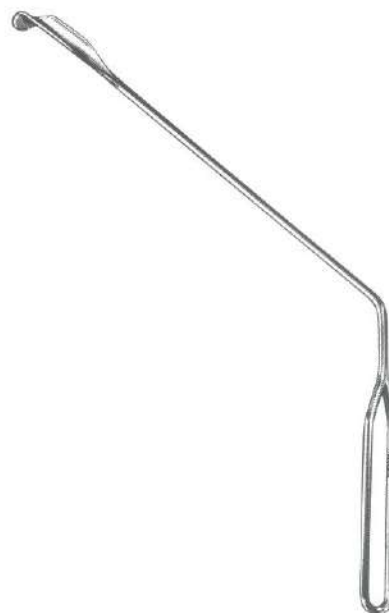

20-835

- 20-800 BARNHILL Adenoid Curette 8½" (21.6 cm), size 0, 11 mm blade
- 20-802 BARNHILL Adenoid Curette 8½" (21.6 cm), size 1, 13 mm blade
- 20-804 BARNHILL Adenoid Curette 8½" (21.6 cm), size 2, 15 mm blade
- 20-806 BARNHILL Adenoid Curette 8½" (21.6 cm), size 3, 17 mm blade
- 20-808 BARNHILL Adenoid Curette 8½" (21.6 cm), size 4, 19 mm blade
- 20-809 VOGEL Adenoid Curette 8½" (21.6 cm), infant size, 7 mm blade
- 20-835 LOTHROP Uvula Retractor 8" (20.3 cm) shaft, grooved blade 40 x 18 mm with 5 mm lip
- 20-836 LOVE Uvula Retractor, 18 mm wide blade
- 20-838 LOVE Uvula Retractor, 20 mm wide blade



20-836
20-838



20-850 to 20-856



20-872 to 20-876

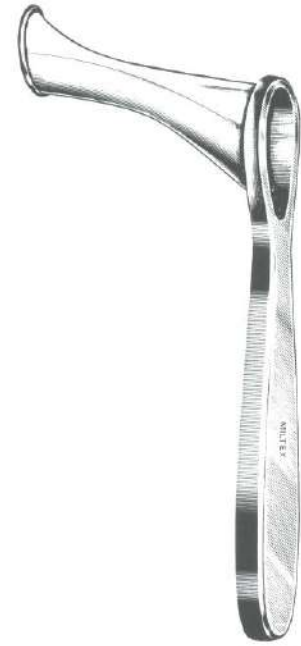

20-890

- 20-850** LAFORCE Adenotome 8½" (21.6 cm), infant size 0, cuts 7 mm width
20-852 LAFORCE Adenotome 9½" (24.1 cm), small size 1, cuts 11 mm width
20-854 LAFORCE Adenotome 9½" (24.1 cm), medium size 2, cuts 13 mm width
20-856 LAFORCE Adenotome 9½" (24.1 cm), large size 3, cuts 16 mm width
- 20-858-0** Blade 10 mm wide, solid, for size 0 LaForce Adenotome
20-858-1 Blade 13 mm wide, perforated, for size 1 LaForce Adenotome
20-858-2 Blade 16 mm wide, perforated, for size 2 LaForce Adenotome
20-858-3 Blade 19 mm wide, perforated, for size 3 LaForce Adenotome
- 20-872** SHAMBAUGH Adenotome 9½" (24.1 cm), reverse curve, small size 1, cuts 11 mm width
20-874 SHAMBAUGH Adenotome 9½" (24.1 cm), reverse curve, medium size 2, cuts 13 mm width
20-876 SHAMBAUGH Adenotome 9½" (24.1 cm), reverse curve, large size 3, cuts 15 mm width
- 20-878-1** Blade 13 mm wide, perforated, for size 1 Shambaugh Adenotome
20-878-2 Blade 16 mm wide, perforated, for size 2 Shambaugh Adenotome
20-878-3 Blade 19 mm wide, perforated, for size 3 Shambaugh Adenotome
- 20-890** YANKAUER Pharyngeal Speculum

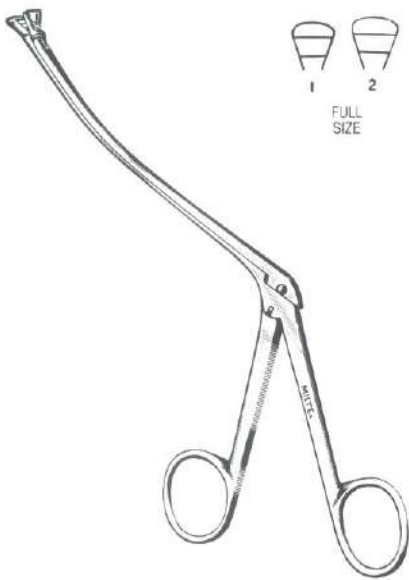

20-910
20-912

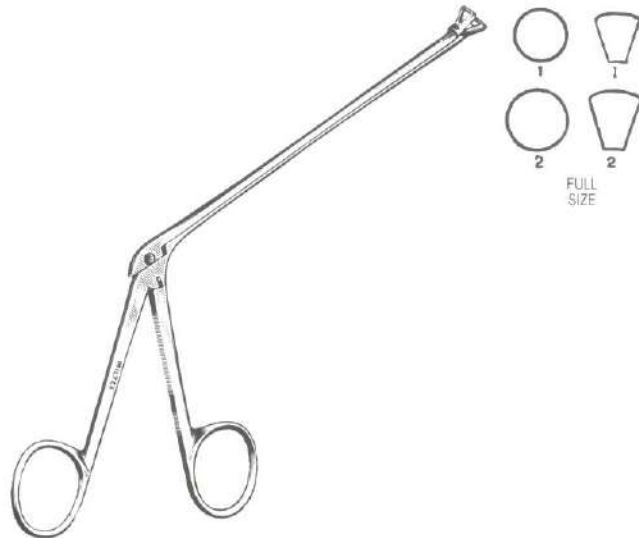

29-922 to 20-928

- 20-910 RONIS Adenoid Punch, 5" (12.7 cm) shaft curved upwards, small triangular jaws
- 20-912 RONIS Adenoid Punch, 5" (12.7 cm) shaft curved upwards, large triangular jaws
- 20-922 MELTZER Adenoid Punch 5" (12.7 cm) shaft, small round jaws with basket, size 1
- 20-924 MELTZER Adenoid Punch 5" (12.7 cm) shaft, large round jaws with basket, size 2
- 20-926 MELTZER Adenoid Punch 5" (12.7 cm) shaft, small triangular jaws with basket, size 1
- 20-928 MELTZER Adenoid Punch 5" (12.7 cm) shaft, large triangular jaws with basket, size 2

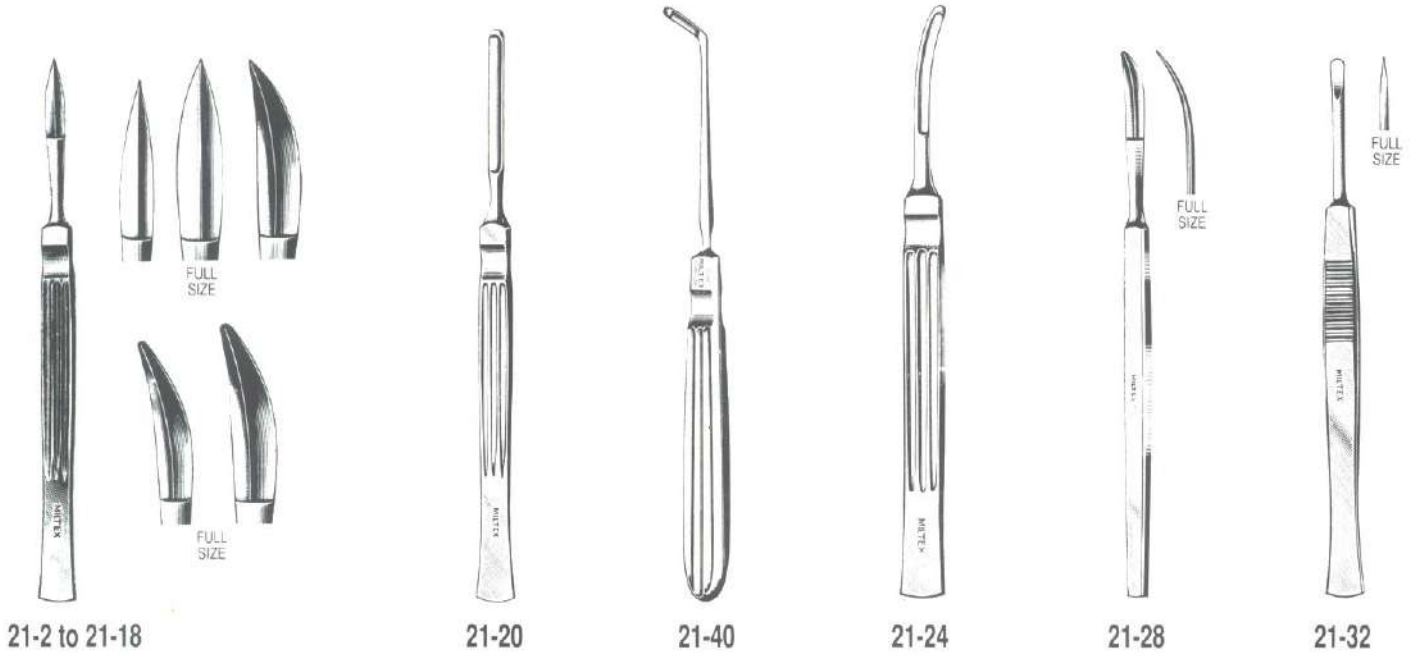

JOSEPH NASAL KNIVES 6" (15.2 cm), Double Edge

Pointed Tips

- 21-2** Small blade, straight
- 21-4** Large blade, straight
- 21-8** Large blade, curved

Blunt Tips

- 21-16** Small blade, curved
- 21-18** Large blade, curved

- 21-20** JOSEPH Button End Knife 6" (15.2 cm), straight blade 4 x 30 mm
- 21-40** JOSEPH Button End Knife 6¼" (15.9 cm), angled blade 4 x 12 mm
- 21-24** CONVERSE Bistouri 6" (15.2 cm), with button end, curved blade 4 x 35 mm
- 21-28** FOMON Knife 5½" (14 cm), double edge, blunt tip, curved
- 21-32** COTTLE Nasal Knife 5½" (14 cm), straight blade, 4 mm wide

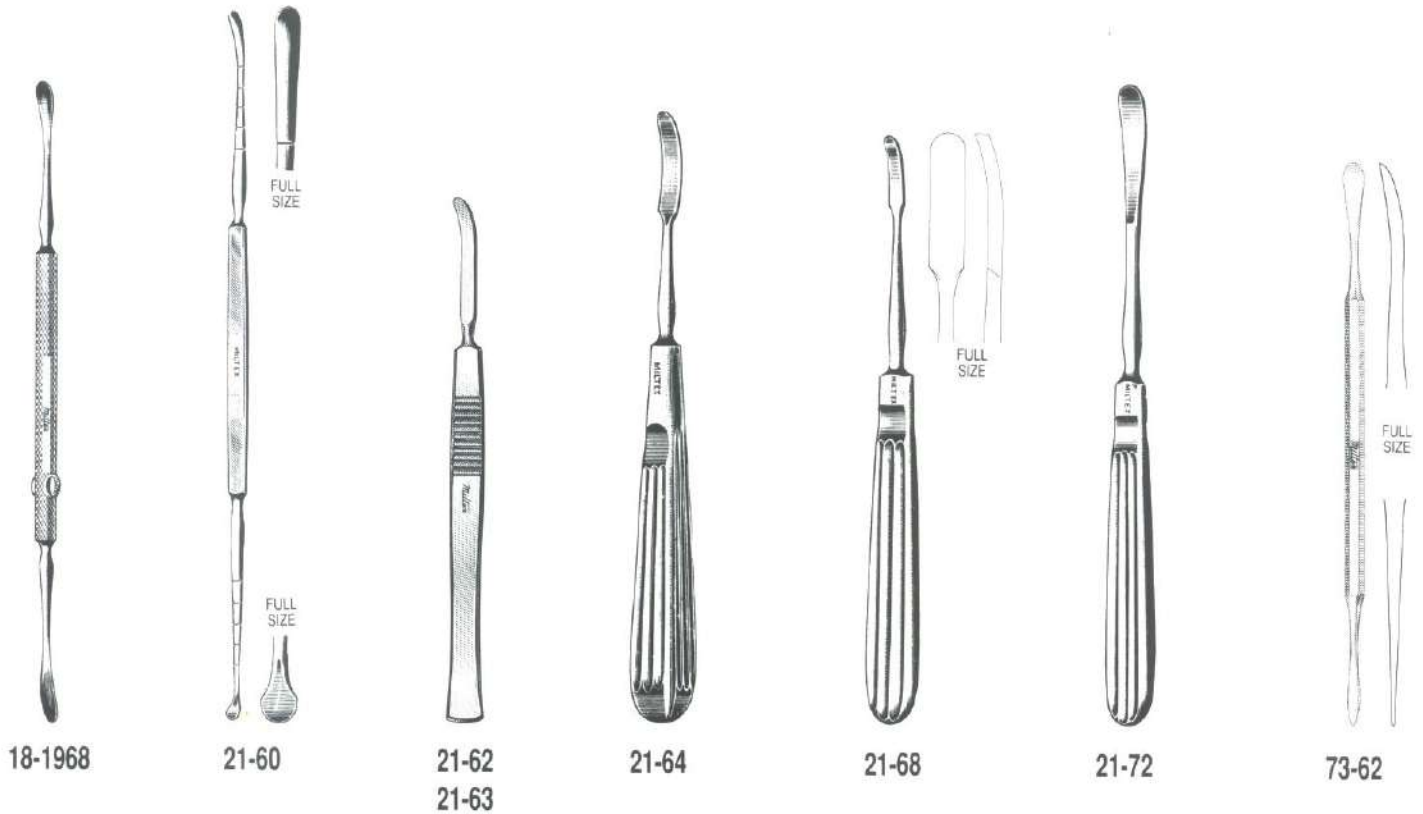

- 18-1968** FREER Septum Elevator 7" (17.8 cm), double end, sharp and blunt blades 5 mm wide
- 21-60** COTTLE Septum Elevator 9" (22.9 cm), double end, graduated in cm.
- 21-62** McKENTY Septum Elevator 5½" (14 cm), curved at tip, 4 mm wide
- 21-63** McKENTY Septum Elevator 5½" (14 cm), curved at tip, 5 mm wide
- 21-64** JOSEPH Periosteal Elevator 7" (17.8 cm), blade 6.5 mm wide, strong curve
- 21-68** FOMON Periosteal Elevator 6¼" (15.9 cm), slightly curved blade 4.5 mm wide, standard pattern
- 21-72** COTTLE Skin Elevator 7½" (19.1 cm), slightly curved blade 9 mm wide
- 73-62** MILTEX Periosteal Elevator 6" (15.2 cm), double end, slightly curved blade 6 mm wide and straight spear point rounded blade 3mm wide
- DELS23** SELDIN Periosteal Elevator 7¾" (19.7 cm), double end, slightly curved blades 10 mm and 13 mm wide



DELS23



Plastic Surgery Instruments

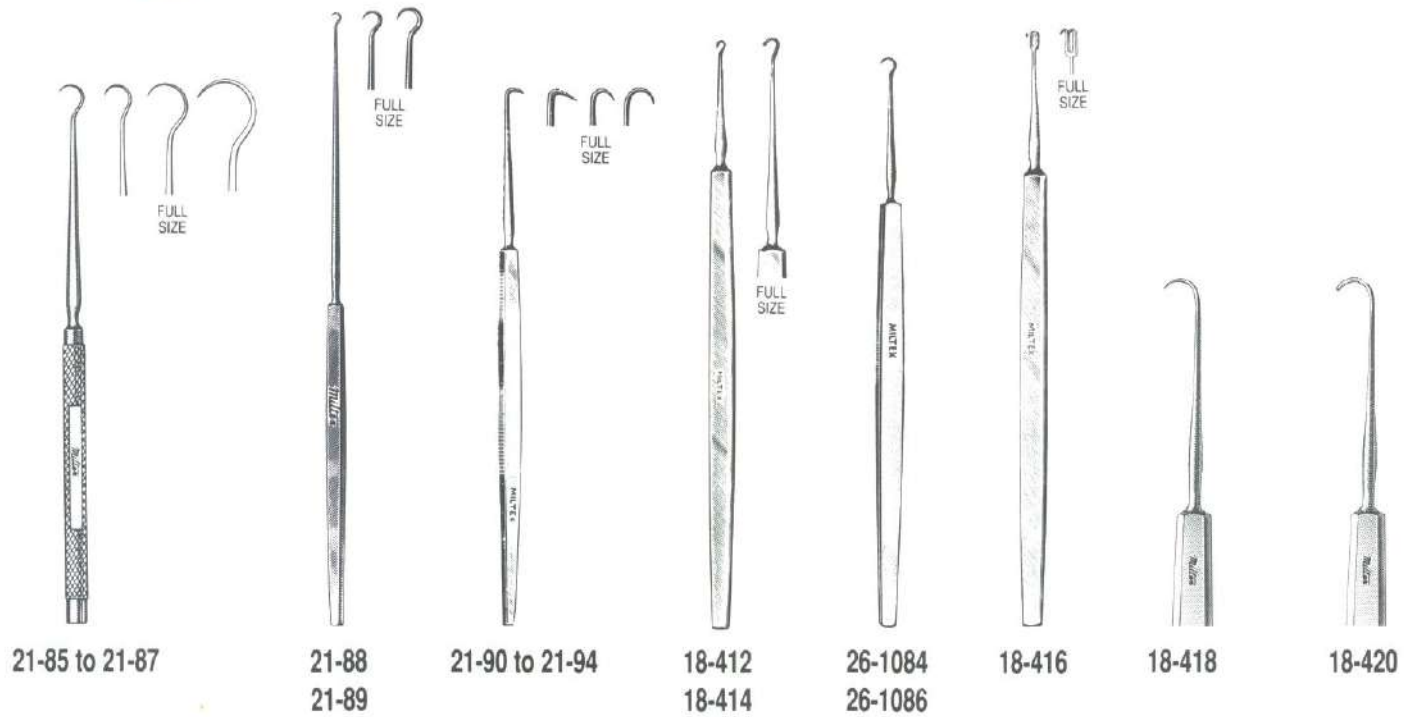

- 21-85 KLEINERT-KUTZ Hook 5" (12.7 cm), small size, 3 mm dia.
- 21-86 KLEINERT-KUTZ Hook 5" (12.7 cm), medium size, 5 mm dia.
- 21-87 KLEINERT-KUTZ Hook 5" (12.7 cm), large size, 7 mm dia.
- 21-88 GILLIES (CONVERSE) Skin Hook 7" (17.8 cm), large size
- 21-89 GILLIES (CONVERSE) Skin Hook 7" (17.8 cm), small size
- 21-90 COTTLE Skin Hook 5½" (14 cm), small, shallow curve
- 21-92 COTTLE Skin Hook 5½" (14 cm), small, deep curve
- 21-94 COTTLE Skin Hook 5½" (14 cm), large, deep curve
- 18-412 TYRELL (Iris) Hook 5" (12.7 cm), sharp
- 18-414 TYRELL (Iris) Hook 5" (12.7 cm), blunt
- 26-1084 FRAZIER Dura Hook 5" (12.7 cm), sharp point
- 26-1086 FRAZIER Dura Hook 5" (12.7 cm), blunt point
- 18-416 GUTHRIE (Iris) Hook 5" (12.7 cm), sharp double prongs 1.5 mm wide
- 18-418 WIENER Hook 5" (12.7 cm), sharp
- 18-420 WIENER Hook 5" (12.7 cm), blunt
- 18-428 NUGENT Hook 4¾" (12.1 cm), right angle, sharp
- 21-102 FREER Skin Hook 6" (15.2 cm), sharp double prongs 2.5 mm wide
- 21-103 FREER Skin Hook 6" (15.2 cm), blunt double prongs 2.5 mm wide

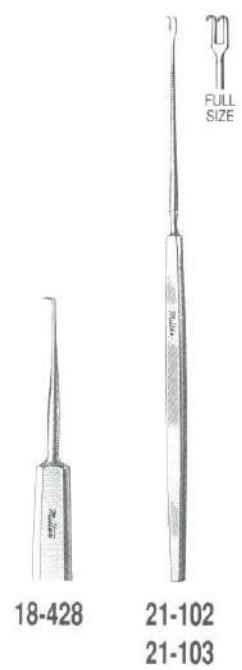

For additional Hooks see pages 188 - 194

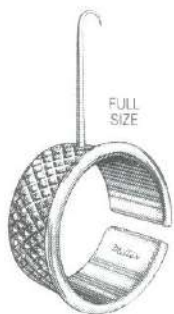

21-107

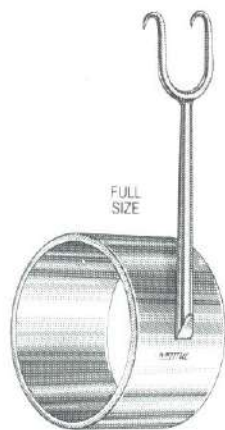

21-108



18-439



11D-27

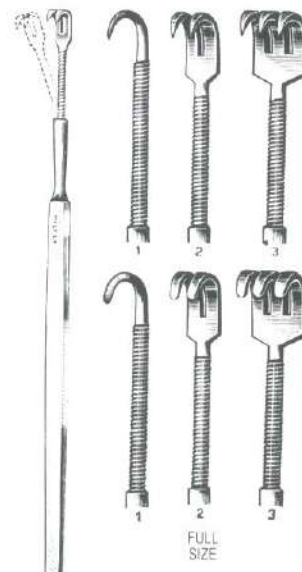

11-30 to 11-40

21-107 MILLARD Thimble Retractor, $\frac{5}{8}$ " (1.6 cm) working length, sharp single hook

21-108 COTTLE Thumb Retractor, $1\frac{1}{2}$ " (3.8 cm) working length, sharp double hook 8 mm wide

18-439 McGANNON Retractor 5" (12.7 cm), fenestrated blade 2.5 mm wide

11D-27 Flexible Neck Rake Retractor 5" (12.7 cm), 3 sharp prongs

11-30 Flexible Neck Rake Retractor 6" (15.2 cm), 1 sharp prong

11-32 Flexible Neck Rake Retractor 6" (15.2 cm), 2 sharp prongs

11-34 Flexible Neck Rake Retractor 6" (15.2 cm), 3 sharp prongs

11-36 Flexible Neck Rake Retractor 6" (15.2 cm), 1 blunt prong

11-38 Flexible Neck Rake Retractor 6" (15.2 cm), 2 blunt prongs

11-40 Flexible Neck Rake Retractor 6" (15.2 cm), 3 blunt prongs

11-50 Rigid Neck Rake Retractor 6" (15.2 cm), 1 sharp prong

11-52 Rigid Neck Rake Retractor 6" (15.2 cm), 2 sharp prongs

11-54 Rigid Neck Rake Retractor 6" (15.2 cm), 3 sharp prongs

11-56 Rigid Neck Rake Retractor 6" (15.2 cm), 1 blunt prong

11-58 Rigid Neck Rake Retractor 6" (15.2 cm), 2 blunt prongs

11-60 Rigid Neck Rake Retractor 6" (15.2 cm), 3 blunt prongs

18-100 KNAPP (ROLLET) Retractor $5\frac{1}{4}$ " (13.3 cm) with 4 sharp prongs

18-102 KNAPP Retractor $5\frac{1}{4}$ " (13.3 cm), with 4 blunt prongs

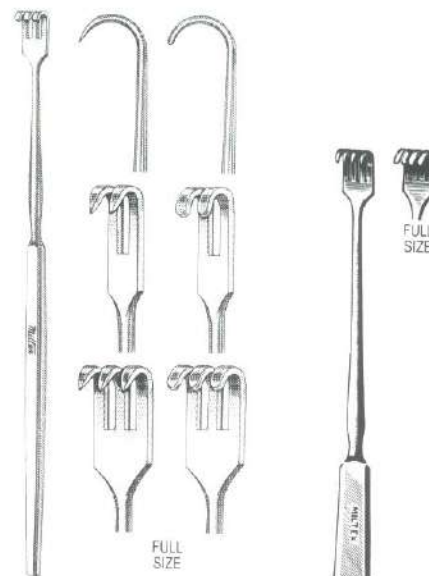

11-50 to 11-60

18-100
18-102



21-144



21-148



21-150



21-152



21-153

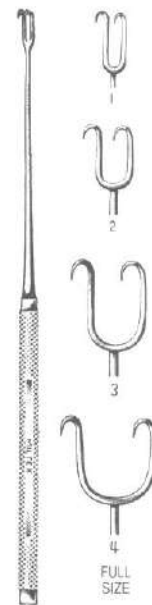

21-154 to 21-160



21-430

21-144 COTTLE Double Hook 5½" (14 cm), two sharp prongs 12 mm wide

21-148 FOMON Retractor 6½" (16.5 cm), two ball end prongs 11 mm wide

21-150 COTTLE Retractor 5½" (14 cm), four blunt prongs, 2 center prongs recessed

21-152 MILTEX Skin Hook 4¾" (12.1 cm), sharp prong 2 mm dia.

21-153 JOSEPH Single Hook 6¼" (15.9 cm), one sharp prong

21-154 JOSEPH Double Hook 6¼" (15.9 cm), two sharp prongs 2 mm

21-156 JOSEPH Double Hook 6¼" (15.9 cm), two sharp prongs 5 mm

21-158 JOSEPH Double Hook 6¼" (15.9 cm), two sharp prongs 7 mm

21-160 JOSEPH Double Hook 6¼" (15.9 cm), two sharp prongs 10 mm

21-430 MILTEX Tissue Twist Hook 5½" (14 cm)

30-950 MILTEX Tenaculum Hook 8" (20.3 cm), extra delicate pointed hook, handle graduated in cm

33-121 SELTZER Dermal Biopsy Hook 4½" (11.4 cm), sharp point

21-163 CONVERSE Alar Retractor 4" (10.2 cm), double end, with blunt double hooks 10 mm and 14 mm wide



30-950



33-121



21-163

For additional Hooks see pages 188 - 194



- 18-110** DESMARRES Alar Retractor 5½" (14 cm), 11 mm wide blade
- 21-165** COTTLE Knife Guide and Retractor 8" (20.3 cm), double end, ball tip prongs 10 mm wide, and 5 mm wide slotted hook
- 11-73** RAGNELL Retractor 6" (15.2 cm), double end 3 x 8 mm and 5 x 15 mm blades, delicate
- 11-74** SENN Retractor 6¾" (16.2 cm), double end, 3 sharp prongs
- 11-76** SENN Retractor 6¾" (16.2 cm), double end, 3 blunt prongs
- 11-80** MATHIEU Retractor 6½" (16.5 cm), double end, 3 sharp prongs
- 11-81** MATHIEU Retractor 6½" (16.5 cm), double end, 3 blunt prongs
- 11-82** MEYERDING Skin Hook and Retractor 6¼" (15.9 cm), double end
- 11-88** MEYERDING Finger Retractor 7" (17.8 cm), style A. Blade ¼" (.64 cm) x 1½" (1.7 cm)
- 11-90** MEYERDING Finger Retractor 7" (17.8 cm), style B. Blade ¼" (.48 cm) x 5⁄8" (1.6 cm)
- 11-92** MEYERDING Finger Retractor 7" (17.8 cm), style C. Blade ¼" (.32 cm) x ¼" (.64 cm)
- 11-94** MEYERDING Finger Retractor 7" (17.8 cm), style D. Blade 3⁄32" (.24 cm) x 3⁄8" (1 cm)
- 11-96** MEYERDING Finger Retractor 7" (17.8 cm), style E. Blade ¼" (.64 cm) x 7⁄8" (2.2 cm)
- 23-1007** HUPP Retractor 6" (15.2 cm), 3 sharp prongs 12 mm wide, and probe end 35 mm long
- 23-1047** LUKENS Retractor 6¾" (17.1 cm), 10 mm wide curved and 7 mm wide angular blades



23-1047

For a full line of Retractors see pages 151 - 187

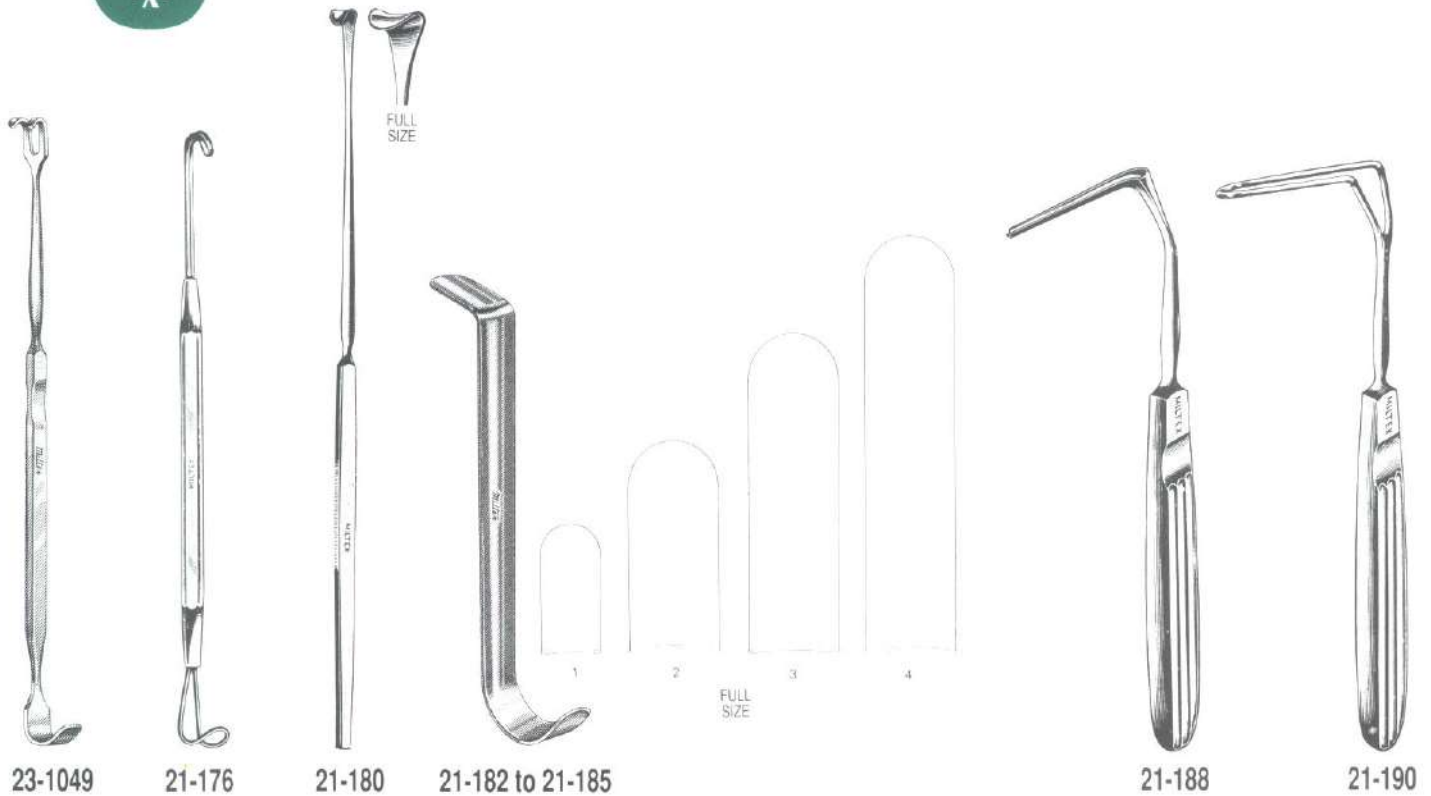

- 23-1049** JACKSON Retractor 7" (17.8 cm), double end, 2 blunt prongs $\frac{5}{16}$ " (2.4 cm) wide, and solid blade $\frac{3}{8}$ " (1 cm) wide
- 21-176** NEIVERT Knife Guide and Retractor 6½" (16.5 cm), double end, open blade 14 mm wide
- 21-180** LOVE Nerve Retractor 8½" (21.6 cm), blade 7 mm wide
- 21-182** CONVERSE Blade Retractor ¾" (9.5 cm), size 1
- 21-183** CONVERSE Blade Retractor ¾" (9.5 cm), size 2
- 21-184** CONVERSE Blade Retractor ¾" (9.5 cm), size 3
- 21-185** CONVERSE Blade Retractor ¾" (9.5 cm), size 4
- 21-188** AUFRICHT Nasal Retractor-Speculum 6½" (16.5 cm), solid blade 45 mm long
- 21-190** AUFRICHT Nasal Retractor 7" (17.8 cm), fenestrated blade 45 mm long
- 20-270** FREER Septum Chisel 6½" (16.5 cm), straight 4 mm wide
- 18-1960** FREER Septum Chisel 6½" (16.5 cm), curved 4 mm wide
- 20-274** FREER Septum Gouge 6¼" (15.9 cm), straight 6 mm wide

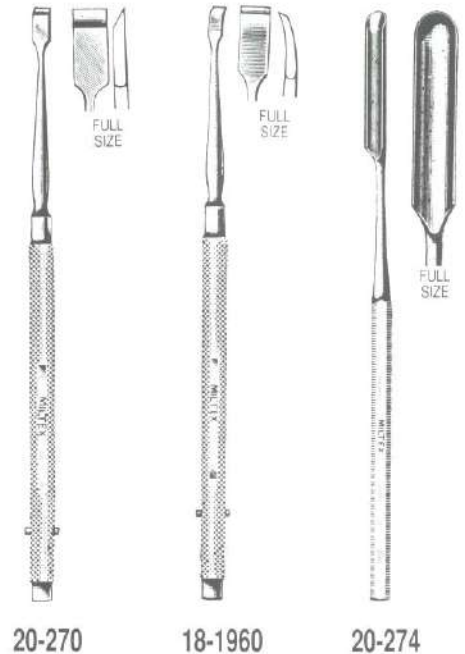

For a full line of Retractors see pages 151 - 187

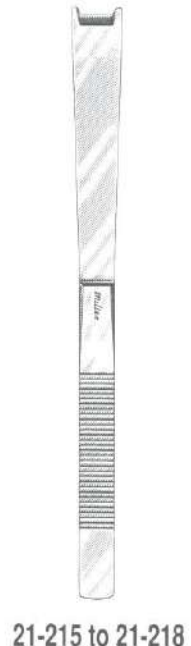
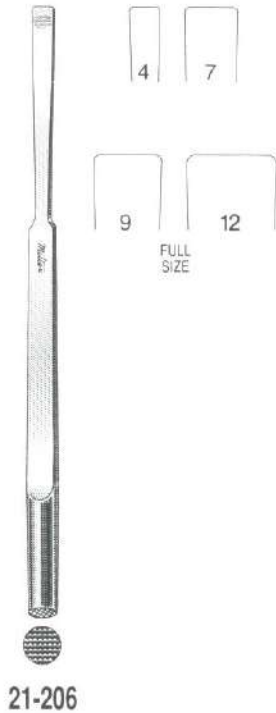
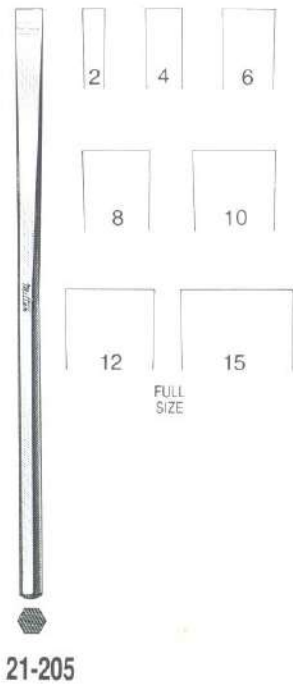

SHEEHAN OSTEOTOMES 6¼" (15.9 cm), hexagon handle

- | | | | |
|-----------------|-----------|------------------|------------|
| 21-205-2 | 2 mm wide | 21-205-10 | 10 mm wide |
| 21-205-4 | 4 mm wide | 21-205-12 | 12 mm wide |
| 21-205-6 | 6 mm wide | 21-205-15 | 15 mm wide |
| 21-205-8 | 8 mm wide | | |

- 21-206-4** COTTLE Osteotome 7" (17.8 cm), 4 mm wide, rounded corners
21-206-7 COTTLE Osteotome 7" (17.8 cm), 7 mm wide, rounded corners
21-206-9 COTTLE Osteotome 7" (17.8 cm), 9 mm wide, rounded corners
21-206-12 COTTLE Osteotome 7" (17.8 cm), 12 mm wide, rounded corners

21-212 COTTLE Chisel 7¼" (18.4 cm), curved 5 mm, with depth graduations in cm.

- 21-215** CINELLI Osteotome 6½" (16.5 cm), with double guards, 10 mm cut
21-216 CINELLI Osteotome 6½" (16.5 cm), with double guards, 12 mm cut
21-217 CINELLI Osteotome 6½" (16.5 cm), with double guards, 14 mm cut
21-218 CINELLI Osteotome 6½" (16.5 cm), with double guards, 16 mm cut

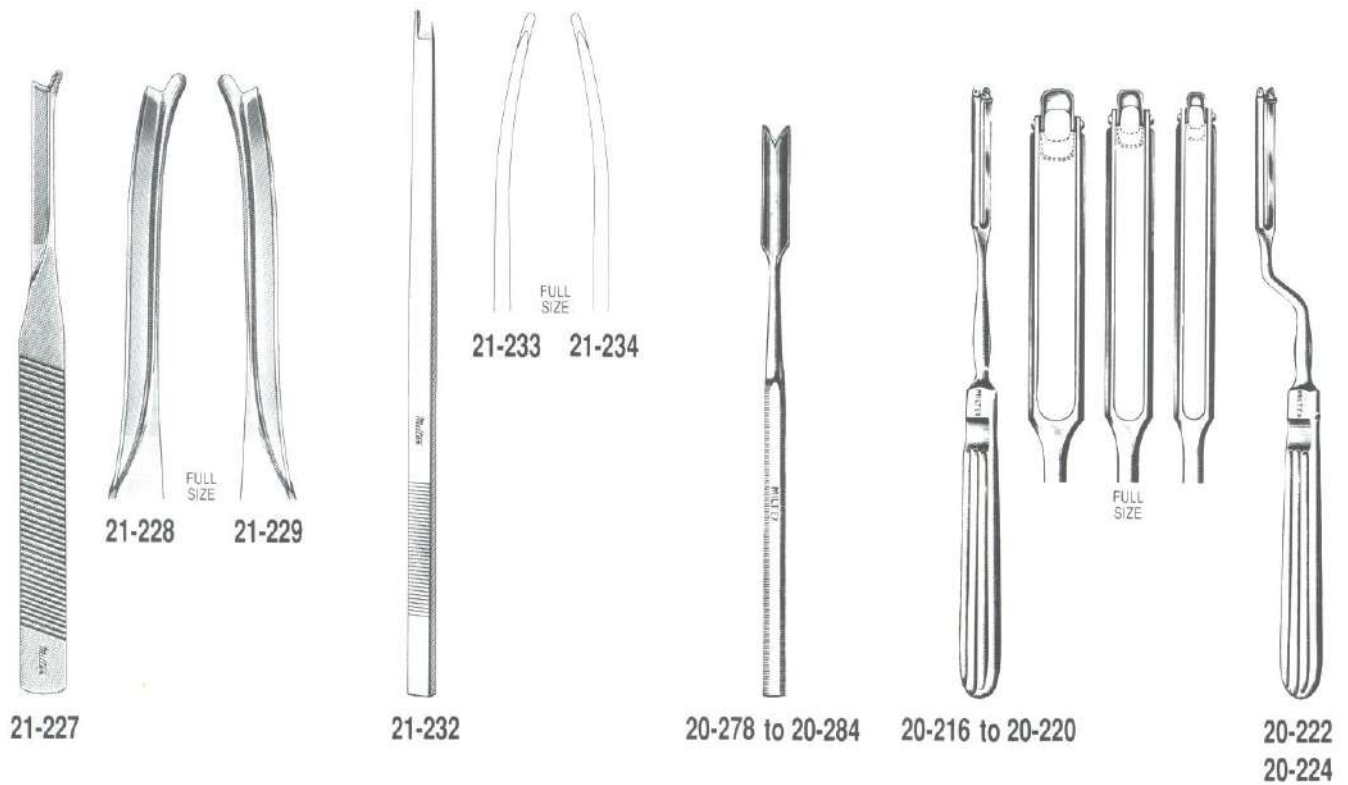

- 21-227 SILVER Osteotome 7" (17.8 cm), single guard, straight
- 21-228 SILVER Osteotome 7" (17.8 cm), single guard, right
- 21-229 SILVER Osteotome 7" (17.8 cm), single guard, left
- 21-232 NEIVERT Osteotome 8" (20.3 cm), straight, with single guard
- 21-233 NEIVERT-ANDERSON Osteotome 8" (20.3 cm), curved right, with single guard
- 21-234 NEIVERT-ANDERSON Osteotome 8" (20.3 cm), curved left, with single guard
- 20-278 BALLENGER V-Shaped Chisel 6¼" (15.9 cm), 2 mm wide
- 20-280 BALLENGER V-Shaped Chisel 6¼" (15.9 cm), 4 mm wide
- 20-282 BALLENGER V-Shaped Chisel 6¼" (15.9 cm), 6 mm wide
- 20-284 BALLENGER V-Shaped Chisel 6¼" (15.9 cm), 8 mm wide

BALLENGER SWIVEL KNIVES 7¾" (19.7 cm)

Straight	Width	Bayonet
20-216	3 mm	20-222
20-218	4 mm	20-224
20-220	5 mm	—

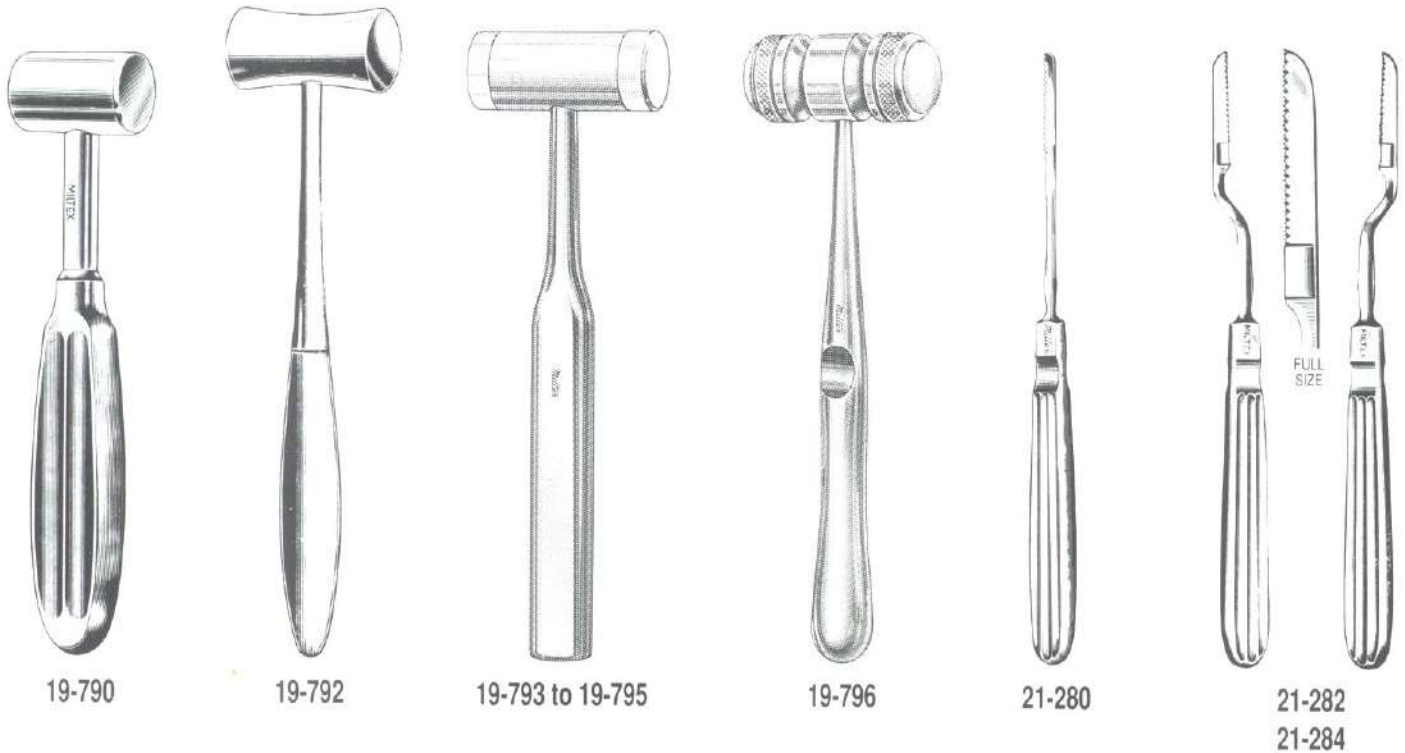

- 19-790 GERZOG Mallet 7½" (19.1 cm), head 8 oz. (226 g) lead filled with stainless jacket
- 19-792 LUCAE Mallet 7½" (19.1 cm), head 9 oz. (255 g), solid stainless
- 19-793 MILTEX Mallet 7½" (19.1 cm), lightweight 7.5 oz. (213 g), stainless head 1" (2.5 cm) dia. with 2 replaceable nylon caps
- 19-794 MILTEX Mallet 7½" (19.1 cm), lightweight 9 oz. (255 g), stainless head 1" (2.5 cm) dia. with 1 stainless face and 1 replaceable nylon cap
- 19-795 Nylon Cap Replacement for Nos. 19-793 and 19-794 Mallets
- 19-796 MEAD Mallet 7½" (19.1 cm), head 8 oz. (226 g) with 2 replaceable nylon caps
- 19-797 Nylon Cap Replacement for No. 19-796 Mallet
- 21-280 JOSEPH Nasal Saw 7½" (19.1 cm), straight
- 21-282 JOSEPH Nasal Saw 7½" (19.1 cm), bayonet, right
- 21-284 JOSEPH Nasal Saw 7½" (19.1 cm), bayonet, left
- 40-2000 MILTEX Nasal Saw 6" (15.2 cm), blade 2" (5.1 cm)



40-2000

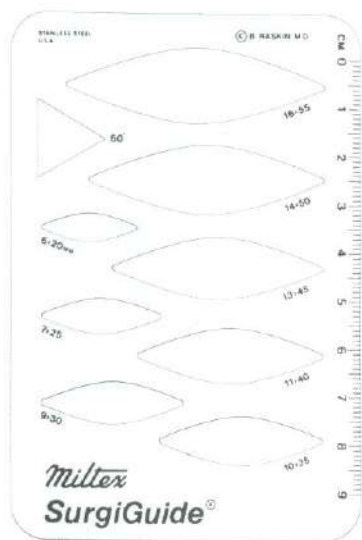

21-278



21-288
21-290

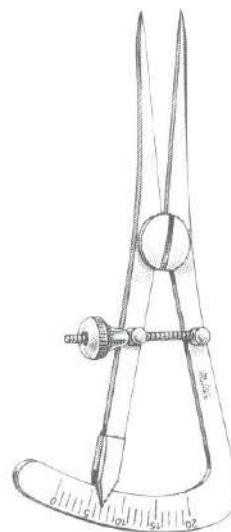

18-650



18-657

21-278 SURGIGUIDE Template for outlining lesions, 110 x 75 mm, flexible stainless steel

21-288 JOSEPH Nasal Saw, angled right

21-290 JOSEPH Nasal Saw, angled left

18-650 CASTROVIEJO Caliper 3/4" (8.3 cm), a combination measuring and marking caliper, graduated 0-20 mm

18-657 THORPE Caliper 4 1/2" (11.4 cm), graduated in inches and mm

18-658 JAMESON Caliper 3 3/4" (9.5 cm), graduated in inches and mm, with thin tips

18-660 Flexible Stainless Ruler 6" (15.2 cm) x 1/2" (1.3 cm), graduated in 1/32" (.8 mm) fractions and mm

21-300 COTTLE Cartilage Crusher, 16 mm wide anvil, with removing forceps



18-658



18-660

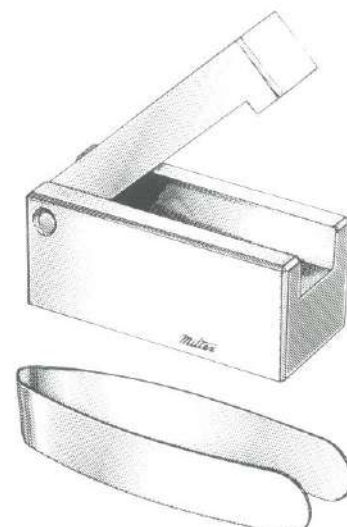

21-300

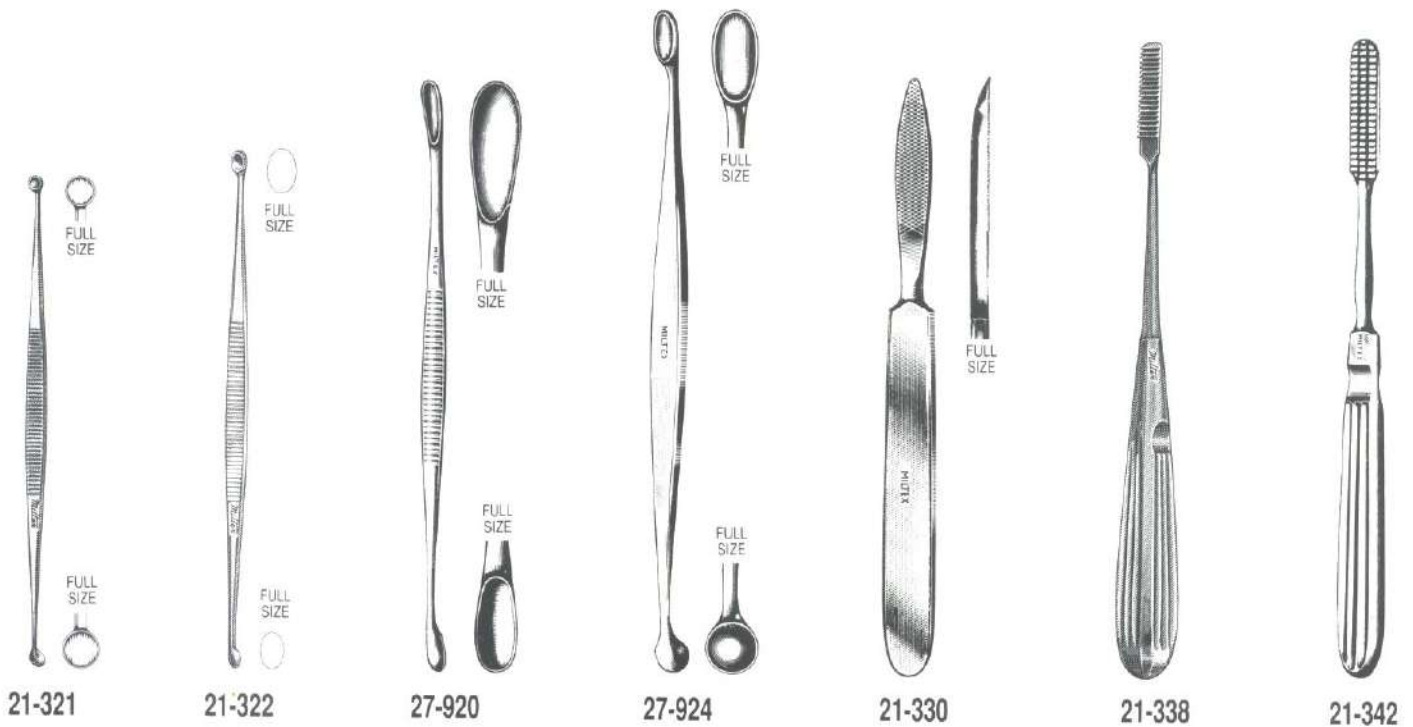

- 21-321** MARTINI Bone Curette 5½" (14 cm), double end, 4 mm and 5 mm round cups
- 21-322** WILLIGER Bone Curette 5½" (14 cm), double end, 3 mm and 4 mm oval cups
- 27-920** VOLKMAN Bone Curette 5½" (14 cm), double end, oval cups 5 x 10 mm and 6 x 20 mm
- 27-924** VOLKMAN Bone Curette 5½" (14 cm), double end, oval cups 6 x 10 mm and round cup 7 mm dia.
- 21-330** JOSEPH Rasp 6¼" (15.9 cm), fine cross serrations
- 21-338** COTTLE Rasp 8" (20.3 cm), backward cutting
- 21-342** MALTZ Rasp 7" (17.8 cm), backward cutting



21-343



21-346
21-348

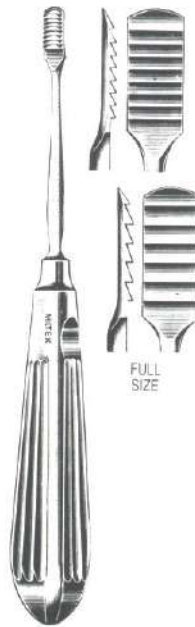

21-352
21-354



21-360



21-368 to 21-370



21-379

- 21-343 MALTZ Rasp 8¼" (21 cm), improved double end pattern, one end forward other end backward cutting
- 21-346 AUFRICHT Glabella Rasp 8¼" (21 cm), curved blade, forward cutting
- 21-348 AUFRICHT Glabella Rasp 8¼" (21 cm), curved blade, backward cutting
- 21-352 LEWIS Rasp 7½" (19.1 cm), fine teeth, backward cutting
- 21-354 LEWIS Rasp 7½" (19.1 cm), coarse teeth, backward cutting
- 21-360 GALLAHER Rasp 6½" (16.5 cm), coarse teeth, convex
- 21-368 FOMON Rasp 8¼" (21 cm), double end, 4-sided, fine and coarse teeth, both in flat and convex
- 21-369 FOMON Rasp 8¼" (21 cm), double end, coarse teeth flat and convex
- 21-370 FOMON Rasp 8¼" (21 cm), double end, fine teeth flat and convex
- 21-379 Stainless Wire Brush 6¼", for cleaning rasps and files, Autoclavable
- 3-1001 MILTEX Instrument Cleaning Brushes 7¼" (18.4 cm)
Stainless steel bristles. Designed to clean instrument serrations, rasps, files and burs (set of 3), Autoclavable



3-1001

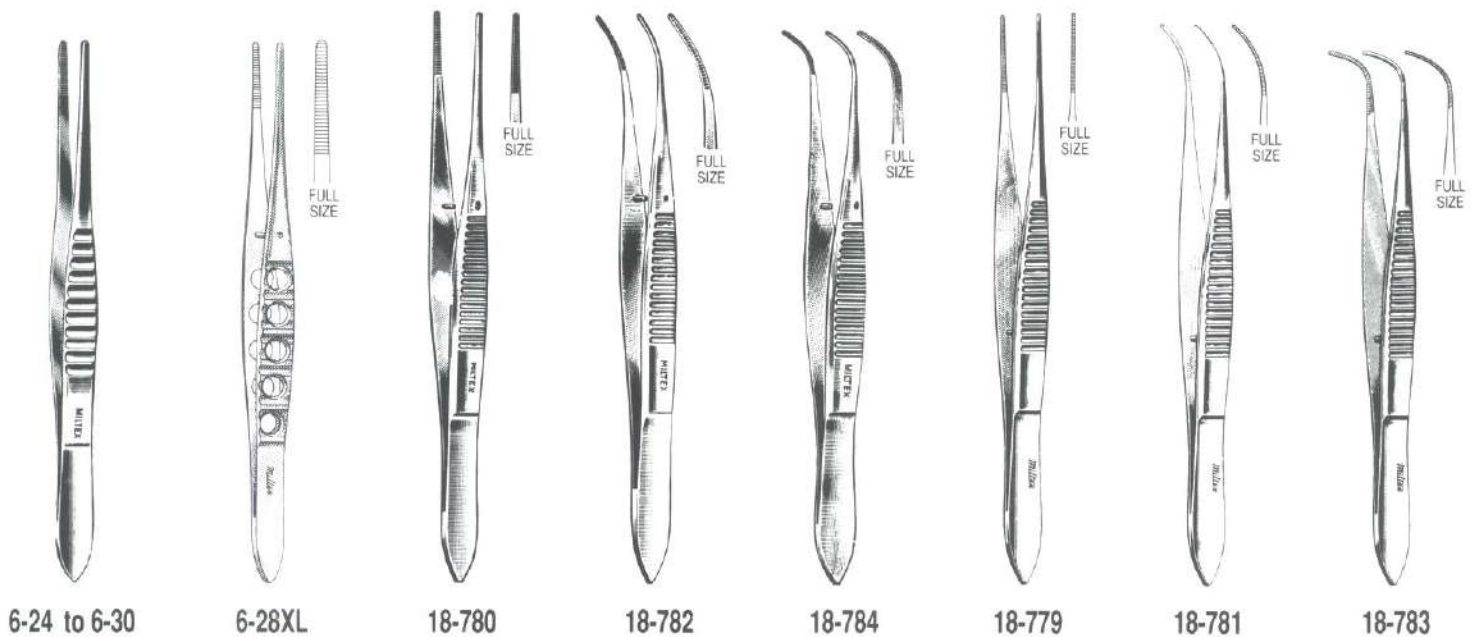

- 6-24** Dressing Forceps 4½" (11.4 cm), delicate pattern
- 6-26** Dressing Forceps 5" (12.7 cm), delicate pattern
- 6-28** Dressing Forceps 5½" (14 cm), delicate pattern
- 6-28XL** Dressing Forceps 5½" (14 cm), delicate pattern, lightweight, fenestrated handles
- 6-30** Dressing Forceps 6" (15.2 cm), delicate pattern

EYE DRESSING FORCEPS 4" (10.2 cm), SERRATED TIPS

Standard Pattern 0.8 mm wide tips		Extra Delicate Pattern 0.5 mm wide tips	
18-780	Straight	18-779	Straight
18-782	Half curved	18-781	Half curved
18-784	Full curved	18-783	Full curved

For additional Dressing & Tissue Forceps see pages 64 - 82

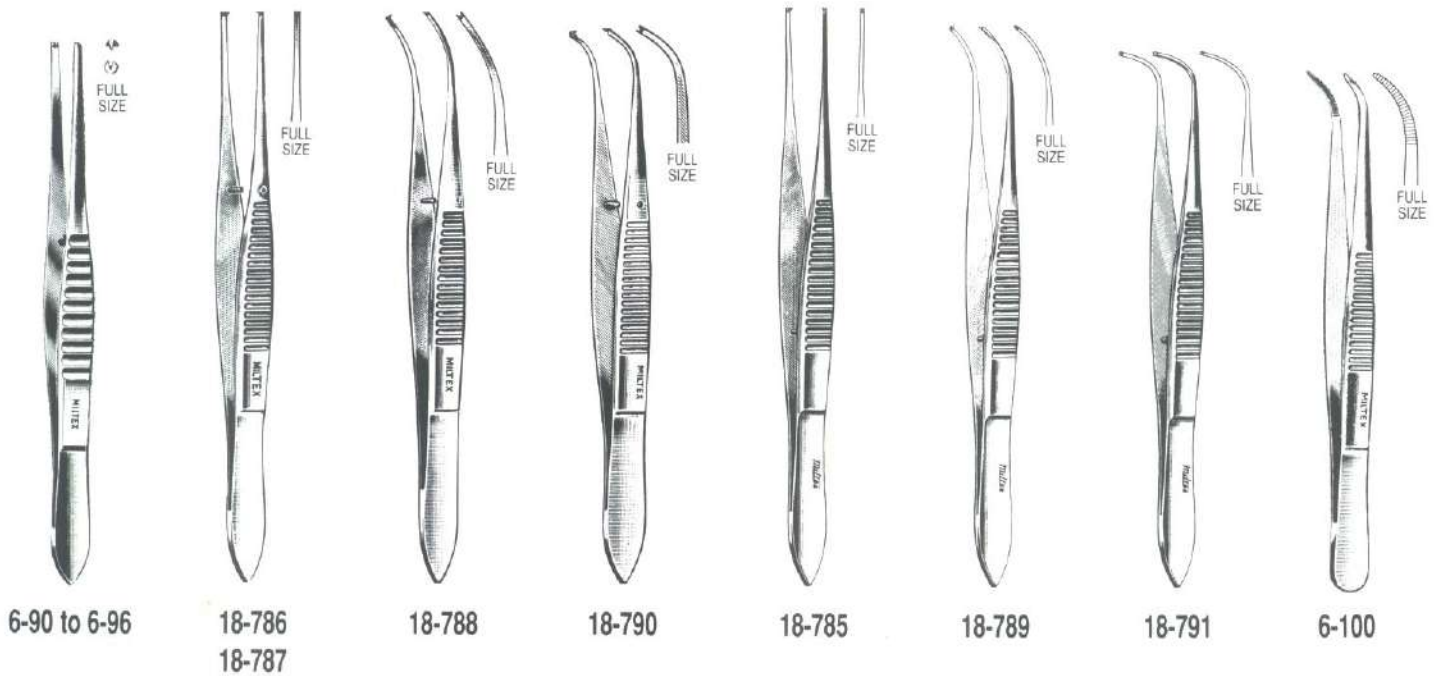

- 6-90** Tissue Forceps, 1 x 2 teeth, 4½" (11.4 cm), delicate pattern
- 6-92** Tissue Forceps, 1 x 2 teeth, 5" (12.7 cm), delicate pattern
- 6-94** Tissue Forceps, 1 x 2 teeth, 5½" (14 cm), delicate pattern
- 6-96** Tissue Forceps, 1 x 2 teeth, 6" (15.2 cm), delicate pattern

IRIS TISSUE FORCEPS 4" (10.2 cm), 1 x 2 TEETH

Standard Pattern 0.8 mm wide tips		Extra Delicate Pattern 0.5 mm wide tips	
18-786	Straight	18-785	Straight
18-787	Straight (Non Magnetic)	18-789	Half curved
18-788	Half curved	18-791	Full curved
18-790	Full curved		
6-100	Dressing Forceps 5" (12.7 cm), curved fine tips		

For additional Dressing & Tissue Forceps see pages 64 - 82

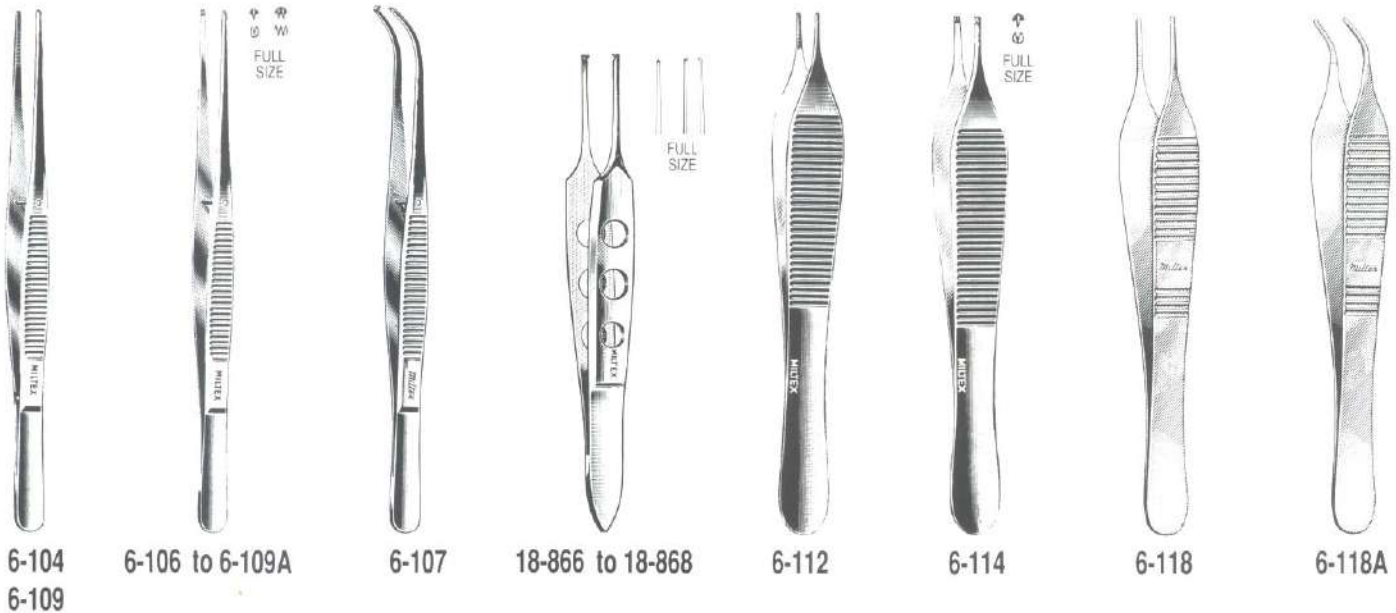

- 6-104** SEMKEN Dressing Forceps 5" (12.7 cm), serrated
- 6-106** SEMKEN Tissue Forceps 5" (12.7 cm), 1 x 2 teeth
- 6-107** SEMKEN Tissue Forceps 5" (12.7 cm), 1 x 2 teeth, curved tips
- 6-108** SEMKEN Tissue Forceps 5" (12.7 cm), 2 x 3 teeth
- 6-109** SEMKEN Dressing Forceps 6" (15.2 cm), serrated
- 6-109A** SEMKEN Tissue Forceps 6" (15.2 cm), 1 x 2 teeth
- 18-866** BISHOP-HARMON Dressing Forceps 3³/₈" (8.6 cm), fine cross-serrated tips 0.5 mm wide
- 18-867** BISHOP-HARMON Micro Tissue Forceps 3³/₈" (8.6 cm), delicate 0.3 mm 1 x 2 teeth
- 18-868** BISHOP-HARMON Tissue Forceps 3³/₈" (8.6 cm), standard 0.7 mm 1 x 2 teeth
- 6-112** HUDSON (EWALD) Dressing Forceps 4³/₄" (12.1 cm), serrated
- 6-114** HUDSON (EWALD) Tissue Forceps 4³/₄" (12.1 cm), 1 x 2 teeth
- 6-118** ADSON Dressing Forceps 4³/₄" (12.1 cm), serrated, delicate
- 6-118A** ADSON Dressing Forceps 4³/₄" (12.1 cm), serrated, delicate, angled
- 6-118XL** ADSON Dressing Forceps 4³/₄" (12.1 cm), serrated, lightweight, fenestrated handles
- 17-2510** Micro ADSON Dressing Forceps 4³/₄" (12.1 cm), serrated tips, 0.5 mm wide

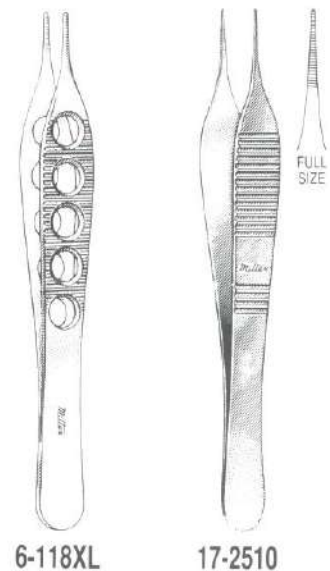

For additional Dressing & Tissue Forceps see pages 64 - 82

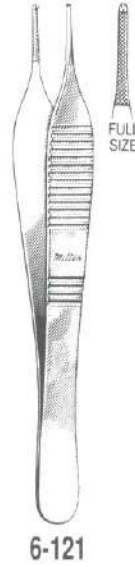

- 6-120** ADSON Tissue Forceps 4¾" (12.1 cm), 1 x 2 teeth, delicate
- 6-120A** ADSON Tissue Forceps 4¾" (12.1 cm), 1 x 2 teeth, delicate, angled
- 6-120XL** ADSON Tissue Forceps 4¾" (12.1 cm), 1 x 2 teeth, lightweight, fenestrated handles
- 6-121** ADSON Tissue Forceps 4¾" (12.1 cm), 1 x 2 teeth and serrated, delicate
- 17-2500** Micro ADSON Tissue Forceps 4¾" (12.1 cm), tips 0.5 mm wide, 1 x 2 teeth
- 6-122** ADSON Tissue Forceps 4¾" (12.1 cm), 2 x 3 teeth, delicate
- 6-123** ADSON Tissue and Suture Forceps 4¾" (12.1 cm), 1 x 2 teeth with tying platform
- 6-123XL** ADSON Tissue Forceps 4¾" (12.1 cm), with platform 1 x 2 teeth, lightweight, fenestrated handles

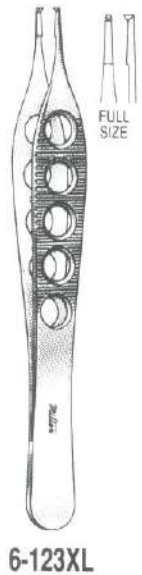

For additional Dressing & Tissue Forceps see pages 64 - 82

Carb-N-Sert Forceps with tungsten carbide inserts are shown on pages 88, 89

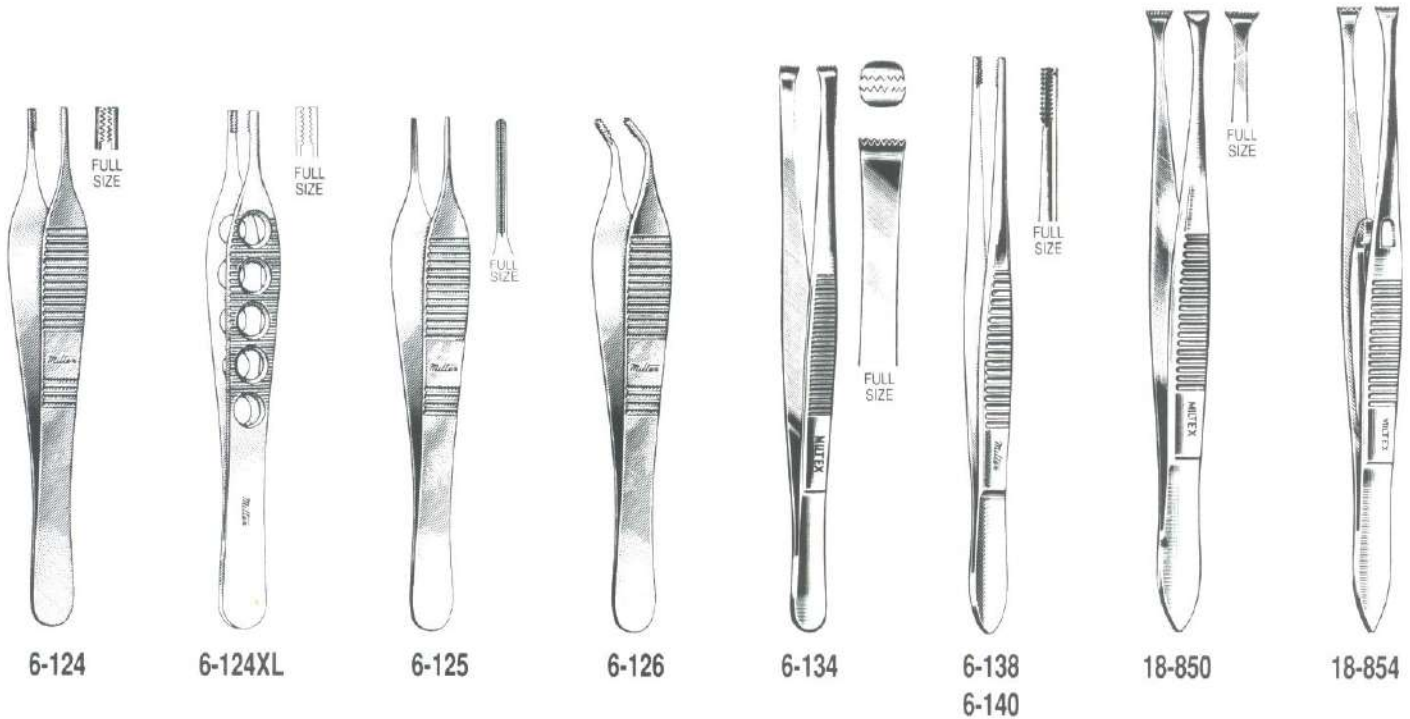

- 6-124** BROWN-ADSON Tissue Forceps 4¾" (12.1 cm), 7 x 7 side grasping teeth
- 6-124XL** BROWN-ADSON Tissue Forceps 4¾" (12.1 cm), 7 x 7 side grasping teeth, lightweight, fenestrated handles
- 6-125** DeBAKEY-ADSON Tissue Forceps 4¾" (12.1 cm), atraumatic tips 1.5 mm wide
- 6-126** BROWN-ADSON Tissue Forceps 4¾" (12.1 cm), 7 x 7 side grasping teeth, angular
- 6-134** MARTIN Tissue Forceps 6" (15.2 cm), 7 x 8 teeth
- 6-138** BROWN Tissue Forceps 6" (15.2 cm), 8 x 8 side grasping teeth
- 6-140** BROWN Tissue Forceps 8" (20.3 cm), 8 x 8 side grasping teeth
- 18-850** GRAEFE Fixation Forceps 4¾" (11.2 cm), standard jaws 4.5 mm wide, with fine teeth
- 18-854** GRAEFE Fixation Forceps 4¾" (11.2 cm), standard jaws 4.5 mm wide, with fine teeth, with catch
- 24-570XL** DeBAKEY Tissue Forceps 6" (15.2 cm), atraumatic teeth, 1.5 mm wide tips, lightweight, fenestrated handles

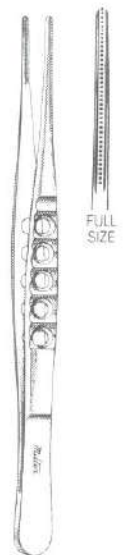

24-570XL

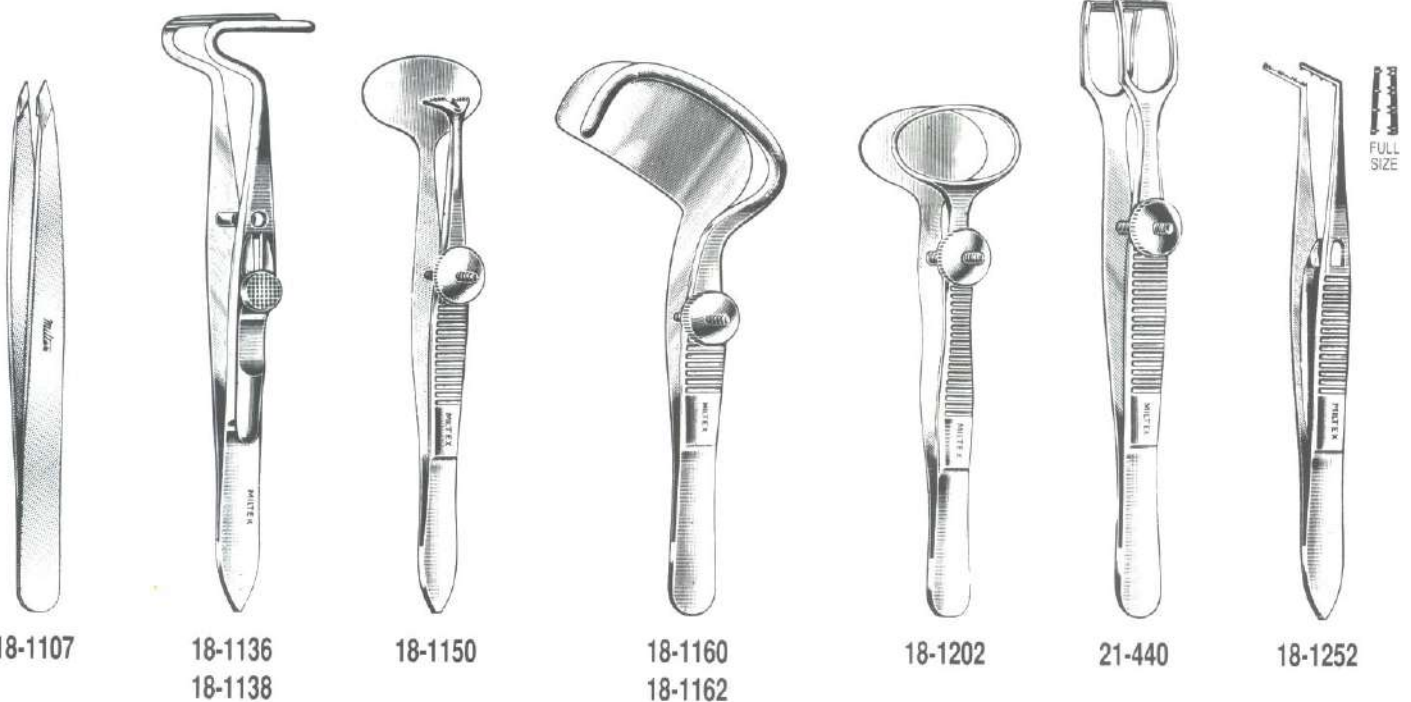

- 18-1107** Swiss Cilia and Suture Forceps 3¾" (9.5 cm), precision fitted diagonal jaws 3 mm wide
- 18-1136** BERKE Ptosis Forceps 4" (10.2 cm), blades 20 mm with longitudinal serrations, with slide lock
- 18-1138** BERKE Ptosis Forceps 4" (10.2 cm), blades 27 mm with longitudinal serrations, with slide lock
- 18-1150** ERHARDT Lid Forceps 3½" (8.9 cm), serrated jaws 9.5 mm wide
- 18-1160** SNELLEN Entropium Forceps 3½" (8.9 cm), left, 35 mm wide plate
- 18-1162** SNELLEN Entropium Forceps 3½" (8.9 cm), right, 35 mm wide plate
- 18-1202** DESMARRES Chalazion Forceps 3½" (8.9 cm), inside ring measures 12 x 23 mm
- 21-440** COTTLE Columella Forceps 4½" (11.4 cm), jaws 10 mm wide
- 18-1252** PRINCE Muscle Forceps 3¾" (9.5 cm)



7-2
7-4



7-8
7-10

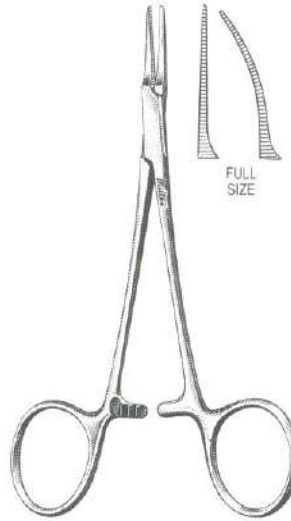

7-11
7-12

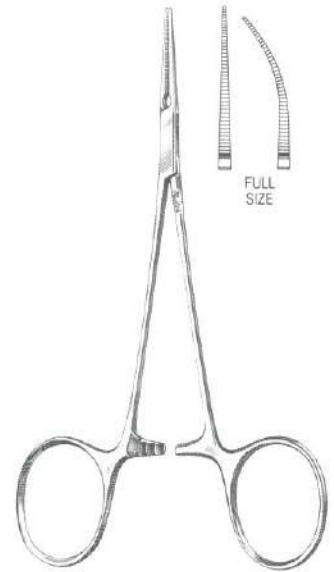

17-2600
17-2602

- 7-2 HALSTED Mosquito Forceps 5" (12.7 cm), straight, standard pattern
- 7-4 HALSTED Mosquito Forceps 5" (12.7 cm), curved, standard pattern
- 7-8 HALSTED Mosquito Forceps 5" (12.7 cm), straight, extra delicate
- 7-10 HALSTED Mosquito Forceps 5" (12.7 cm), curved, extra delicate
- 7-11 PACKER Mosquito Forceps 5" (12.7 cm), straight, flat jaws
- 7-12 PACKER Mosquito Forceps 5" (12.7 cm), curved, flat jaws
- 17-2600 JACOBSON Micro Mosquito Forceps 5" (12.7 cm), straight, extremely delicate
- 17-2602 JACOBSON Micro Mosquito Forceps 5" (12.7 cm), curved, extremely delicate



7-24
7-26

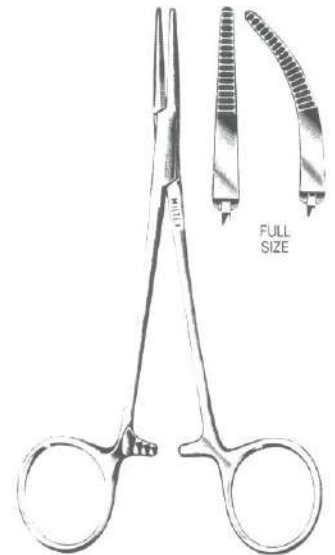

7-30
7-32

- 7-24 HARTMAN Mosquito Forceps 3½" (8.9 cm), straight
- 7-26 HARTMAN Mosquito Forceps 3½" (8.9 cm), curved
- 7-30 PROVIDENCE Hospital Forceps 5½" (14 cm), straight
- 7-32 PROVIDENCE Hospital Forceps 5½" (14 cm), curved

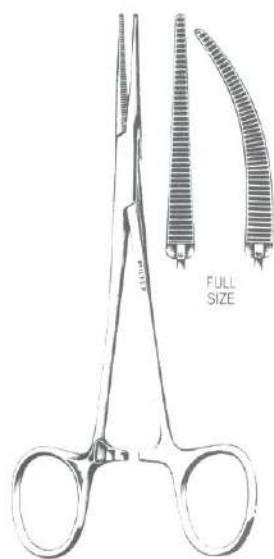

7-50
7-52

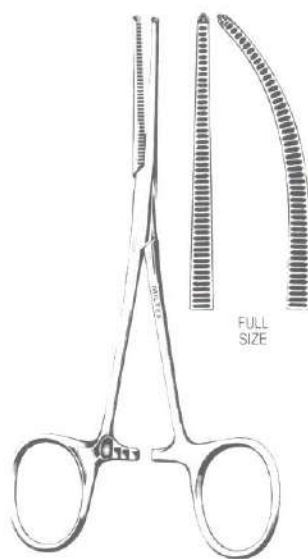

7-70
7-72

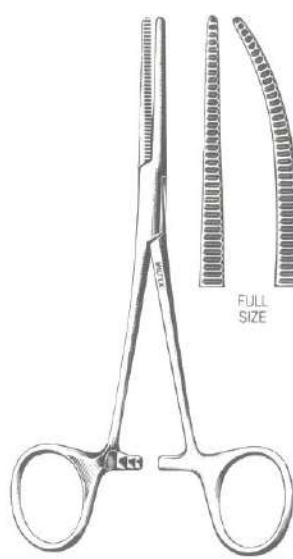

7-110
7-112

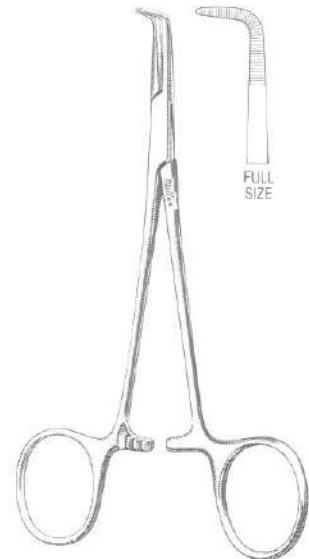

7-210

- 7-50 Baby CRILE Forceps 5½" (14 cm), straight, extra delicate
- 7-52 Baby CRILE Forceps 5½" (14 cm), curved, extra delicate
- 7-70 Baby OCHSNER Forceps 5½" (14 cm), straight, 1 x 2 teeth, extra delicate
- 7-72 Baby OCHSNER Forceps 5½" (14 cm), curved, 1 x 2 teeth, extra delicate
- 7-110 Baby PEAN Forceps 5½" (14 cm), straight, extra delicate
- 7-112 Baby PEAN Forceps 5½" (14 cm), curved, extra delicate
- 7-210 Baby MIXTER Forceps 5¼" (13.3 cm), fully curved, extra delicate

- 7-300 DIEFFENBACH Serrefine 2¼" (5.7 cm), straight
- 7-302 DIEFFENBACH Serrefine 2¼" (5.7 cm), curved
- 7-304 DIEFFENBACH Serrefine 1½" (3.8 cm), straight
- 7-305 DIEFFENBACH Serrefine 1½" (3.8 cm), curved

- 7-310 DIETRICH Micro Bulldog Clamp 1⅞" (4.7 cm), straight jaws
8 mm x 1.2 mm
- 7-315 DIETRICH Micro Bulldog Clamp 1¾" (4.4 cm), angled jaws
8 mm x 1.2 mm



7-300
7-304



7-302
7-305



7-310

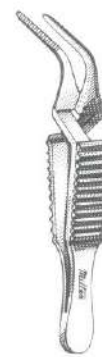

7-315

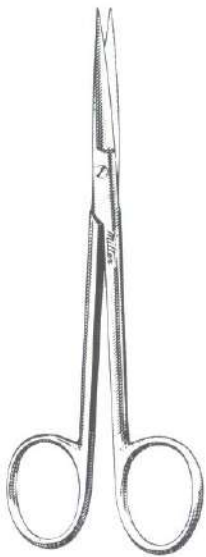

5-270
5-271



5-272
5-273

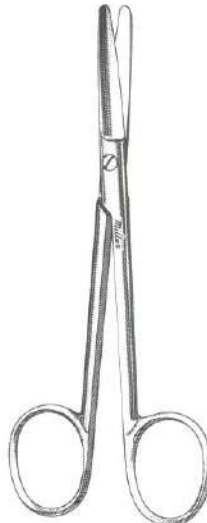

5-274
5-275



5-276
5-277

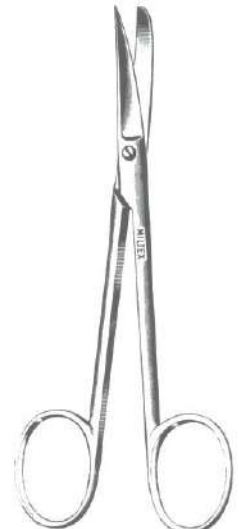

5-278
5-279

MILTEX PLASTIC SURGERY SCISSORS 4 3/4" (12.1 cm)

Straight

- 5-270 Sharp-Sharp Points
- 5-271 Sharp-Sharp Points, serrated blade
- 5-272 Sharp-Blunt Points
- 5-273 Sharp-Blunt Points, serrated blade
- 5-274 Blunt-Blunt Points
- 5-275 Blunt-Blunt Points, serrated blade

Curved

- 5-276
- 5-277
- 5-278
- 5-279
- 5-280
- 5-281

Angled on Side

- 5-282 Sharp-Sharp Points
- 5-282A Sharp-Sharp Points, serrated blade

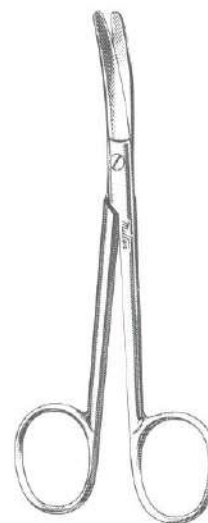

5-280
5-281

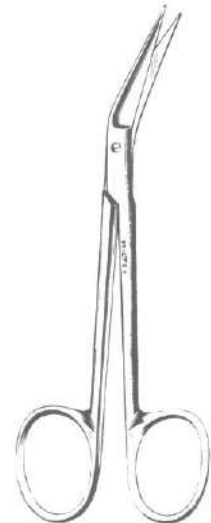

5-282
5-282A

For Carb-N-Sert Scissors with tungsten carbide blades see pages 55 - 59

For SuperCut Scissors see pages 60 - 63



- 18-1396** Iris Scissors 3½" (8.9 cm), with 20 mm blades, straight, very delicate
- 18-1398** Iris Scissors 3½" (8.9 cm), with 20 mm blades, curved, very delicate
- 5-300** Iris Scissors 4" (10.2 cm), straight, delicate
- 5-302** Iris Scissors 4" (10.2 cm), curved, delicate
- 5-304** Iris Scissors 4½" (11.4 cm), straight
- 5-306** Iris Scissors 4½" (11.4 cm), curved
- 5-308** Iris Scissors 4½" (11.4 cm), angled on side
- 5D-303** Iris Scissors 4½" (11.4 cm), curved sideways
- 18-1415*** Iris Scissors 4" (10.2 cm), straight, standard pattern, ribbon type
- 18-1416*** Iris Scissors 4" (10.2 cm), curved, standard pattern, ribbon type
- 18-1417*** Iris Scissors 3½" (8.9 cm), straight, miniature 14 mm blades, ribbon type
- 18-1418*** Iris Scissors 3½" (8.9 cm), curved, miniature 14 mm blades, ribbon type



For Carb-N-Sert Scissors with tungsten carbide inserts see pages 55 - 59

For SuperCut Scissors see pages 60 - 63

*Ribbon type scissors have extra large finger rings; shanks and rings have satin finish; blades are highly polished.

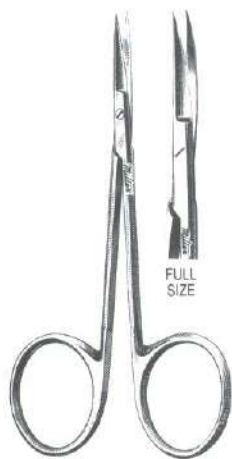

18-1392
18-1394



18-1404



18-1405

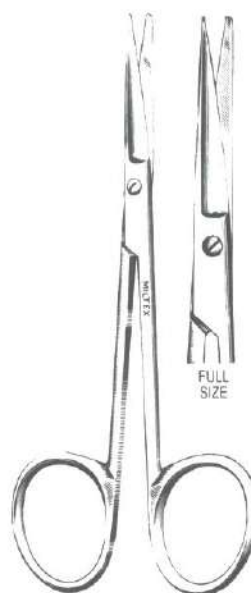

18-1420
18-1422

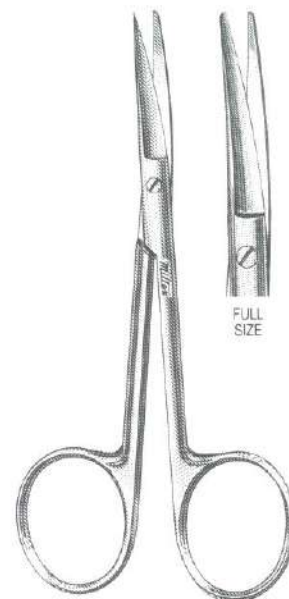

18-1426
18-1428

- 18-1392 BONN Miniature Iris Scissors 3½" (8.9 cm), with 15 mm blades, straight
- 18-1394 BONN Miniature Iris Scissors 3½" (8.9 cm), with 15 mm blades, curved
- 18-1404 MILTEX Iris Scissors 4" (10.2 cm), straight, heavy pattern
- 18-1405 MILTEX Iris Scissors 4" (10.2 cm), curved, heavy pattern
- 18-1420 KNAPP Iris Scissors 4" (10.2 cm), straight, sharp-blunt points
- 18-1422 KNAPP Iris Scissors 4" (10.2 cm), straight, blunt-blunt points
- 18-1426 KNAPP Iris Scissors 4" (10.2 cm), curved, sharp-blunt points
- 18-1428 KNAPP Iris Scissors 4" (10.2 cm), curved, blunt-blunt points
- 5-310 Eye Scissors with Probe Points, 4½" (11.4 cm), angled on side



5-310



Plastic Surgery Instruments

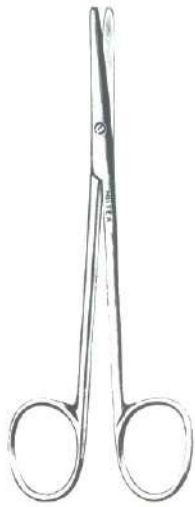

5-312



5-314



18-1453*
18-1454*



5-316



5-318
5D-326

- 5-312** Strabismus Scissors 4" (10.2 cm), straight
- 5-314** Strabismus Scissors 4" (10.2 cm), curved
- 18-1453*** Strabismus Scissors 4½"(11.4 cm), straight, ribbon type
- 18-1454*** Strabismus Scissors 4½"(11.4 cm), curved, ribbon type
- 5-316** BROPHY Gum and Suture Scissors 5½" (14 cm), straight
- 5-318** BROPHY Gum and Suture Scissors 5½" (14 cm), curved
- 5D-326** BROPHY Gum and Suture Scissors 5½" (14 cm), curved, one serrated blade

STEVENS TENOTOMY SCISSORS

4⅛" (10.5 cm) With Short Blades		4½" (11.4 cm) With Long Blades
18-1460	straight, sharp points	18-1470
18-1462	straight, blunt points	18-1472
18-1464	curved, sharp points	18-1474
18-1466	curved, blunt points	18-1476

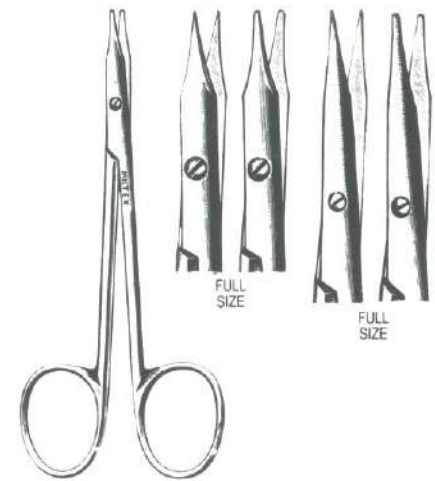

18-1460 to 18-1476

*Ribbon type scissors have extra large finger rings; shanks and rings have satin finish; blades are highly polished.



18-1477*
18-1478*



18-1419*

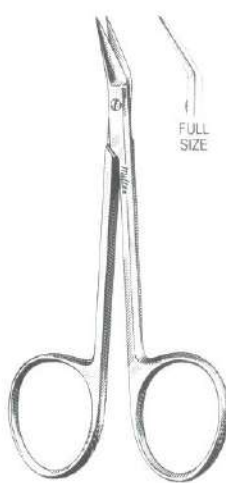

18-1440

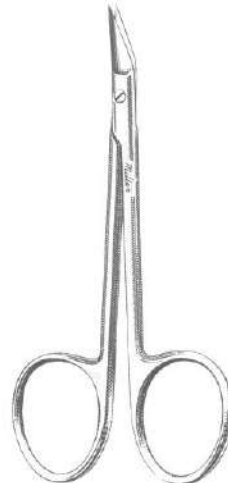

33-240

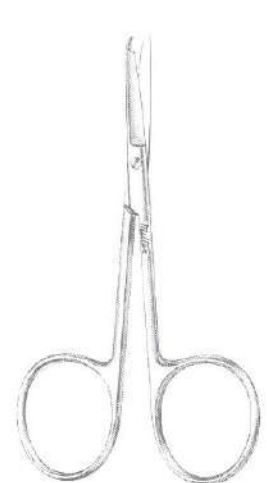

9-100

- 18-1477* STEVENS Tenotomy Scissors 3¾" (9.5 cm), straight, blunt points, ribbon type
- 18-1478* STEVENS Tenotomy Scissors 3¾" (9.5 cm), curved, blunt points, ribbon type
- 18-1419* Utility Scissors 3¾" (9.5 cm), curved blunt blades 15 mm long, ribbon type
- 18-1440 CONVERSE (WILMER) Nasal Scissors 4" (10.2 cm), angled on flat
- 33-240 BIRO Dermal Naevus Scissors 4" (10.2 cm), angled on flat, with sharp outside edges
- 9-100 SPENCER Stitch Scissors 3½" (8.9 cm), straight
- 9-101 SHORTBENT Stitch Scissors 3½" (8.9 cm), curved to side
- 9-102 LITTAUER JR. Stitch Scissors 4½" (11.4 cm), light pattern

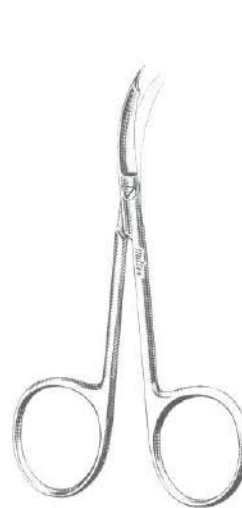

9-101

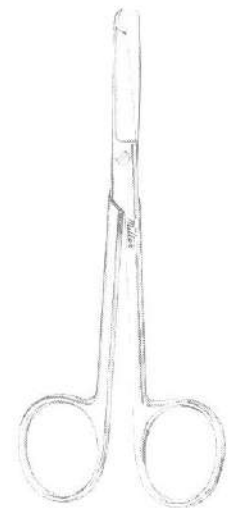

9-102

For Carb-N-Sert Scissors with tungsten carbide inserts see pages 55 - 59

For SuperCut Scissors see pages 60 - 63

*Ribbon type scissors have extra large finger rings; shanks and rings have satin finish; blades are highly polished.

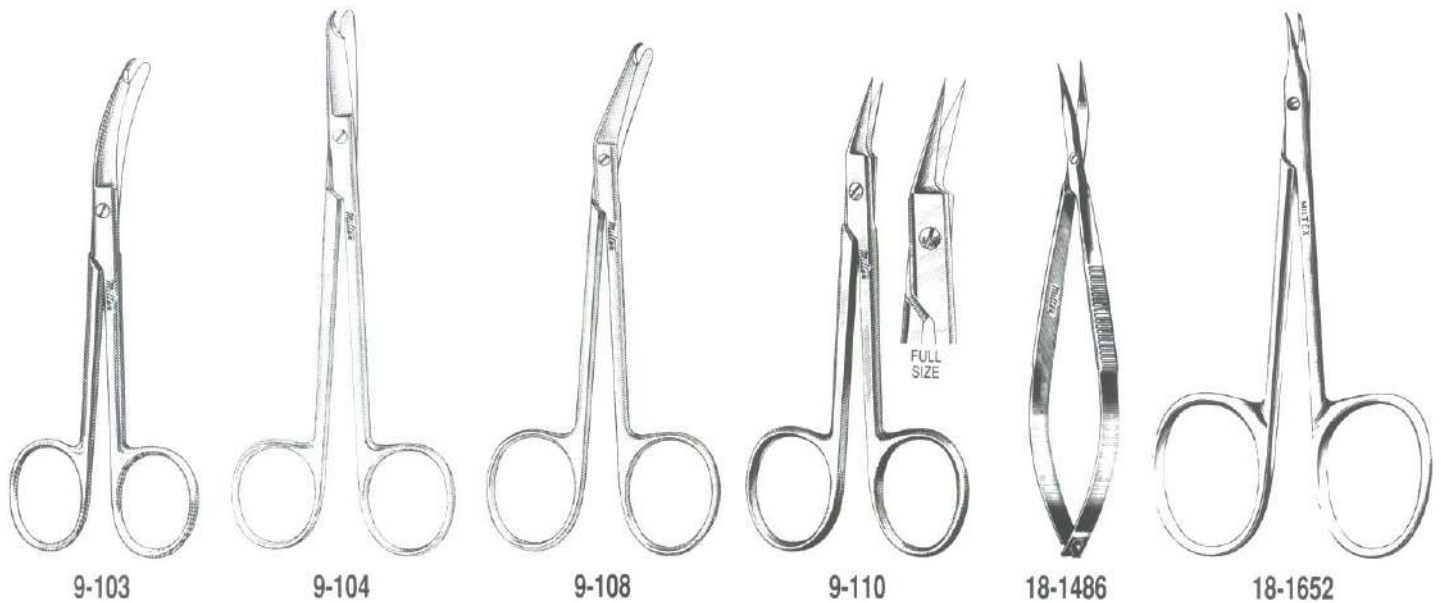

- 9-103 NORTHBENT Stitch Scissors 4¾" (12.1 cm), curved, light pattern
- 9-104 LITTAUER Stitch Scissors 5½" (14 cm), standard pattern
- 9-108 MILTEX Stitch Scissors 4½" (11.4 cm), angled, delicate
- 9-110 O'BRIEN Stitch Scissors 3¾" (9.5 cm), angled to side, sharp points
- 18-1486 WESTCOTT Stitch Scissors 4½" (11.4 cm), curved, sharp points
- 18-1652 Eye Suture (GRADLE) Scissors 3¾" (9.5 cm), slightly curved, sharp points
- 18-1653* Eye Suture Scissors 4" (10.4 cm), slightly curved, sharp points, ribbon type
- 21-536 LITTLER Suture Carrying Scissors 4⅝" (11.8 cm), with suture hole in blades, curved



*Ribbon type scissors have extra large finger rings; shanks and rings have satin finish; blades are highly polished.

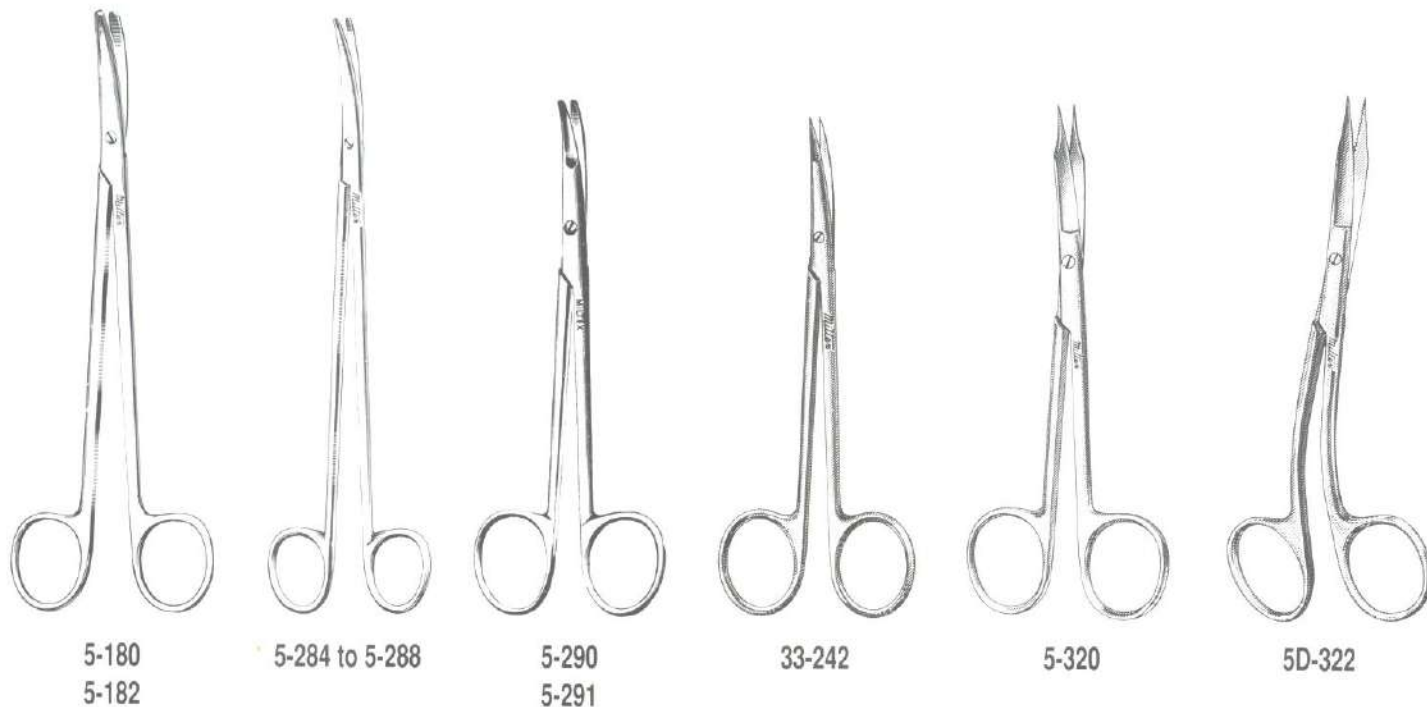

- 5-180 METZENBAUM Scissors 5½" (14 cm), curved, standard
- 5-182 METZENBAUM Scissors 7" (17.8 cm), curved, standard
- 5-284 METZENBAUM Scissors 5" (12.7 cm), curved, delicate
- 5-286 METZENBAUM Scissors 6" (15.2 cm), curved, delicate
- 5-288 METZENBAUM Scissors 7" (17.8 cm), curved, delicate

- 5-290 RAGNELL Undermining Scissors 5" (12.7 cm), curved with flattened dissecting tips
- 5-291 RAGNELL Undermining Scissors 7" (17.8 cm), curved with flattened dissecting tips

- 33-242 MILTEX Undermining Scissors 4½" (11.4 cm), curved blades, with flat pointed tip

- 5-320 GOLDMAN-FOX Wound Debridement Scissors 5" (12.7 cm), curved fine tips, with one serrated blade

- 5D-322 GOLDMAN-FOX Wound Debridement Scissors 5" (12.7 cm), double curved, with one serrated blade

- 5D-324 LaGRANGE Scissors 4¼" (10.8 cm), curved, one serrated blade, angled shanks

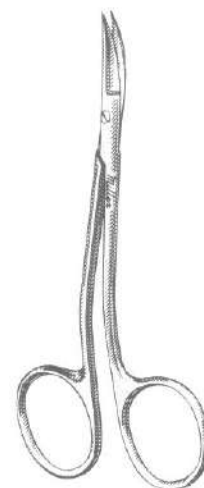

5D-324

For Carb-N-Sert Scissors with tungsten carbide inserts see pages 55 - 59

For SuperCut Scissors see pages 60 - 63



21-537TC

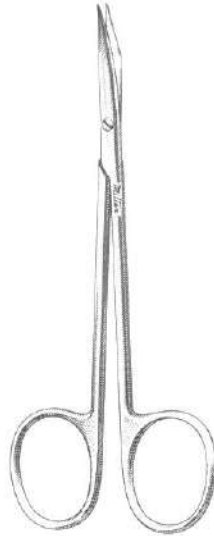

21-539



5-172
5-176

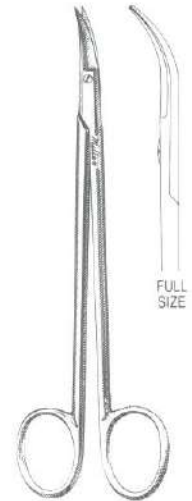

21-558
21D-559

- 21-537TC** MILTEX Blepharoplasty Scissors 4½" (11.4 cm), curved flat tips, one serrated and one CARB-N-SERT blade
- 21-539** KLEINERT-KUTZ Tenotomy Scissors 4⅞" (12.4 cm), curved, rounded dissecting blades
- 5-172** REYNOLDS Dissecting Scissors 6" (15.2 cm), curved tenotomy type dissecting tips
- 5-176** REYNOLDS Dissecting Scissors 7" (17.8 cm), curved tenotomy type dissecting tips
- 21-558** QUIMBY Scissors 5" (12.7 cm), blades 15 mm, strongly curved and pointed
- 21D-559** QUIMBY Scissors 5" (12.7 cm), blades 15 mm, strongly curved and pointed, one serrated blade
- 21-560** TAYLOR Dural Scissors 5½" (14 cm), with probe tip

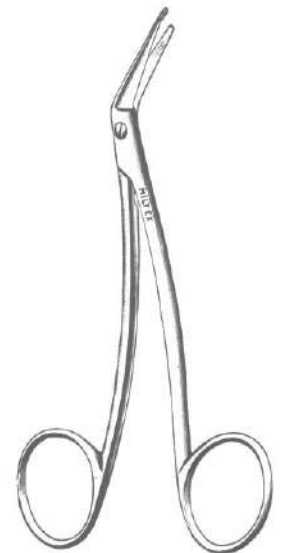

21-560

For Carb-N-Sert Scissors with tungsten carbide inserts see pages 55 - 59

For SuperCut Scissors see pages 60 - 63



5-152
5-154



21-600

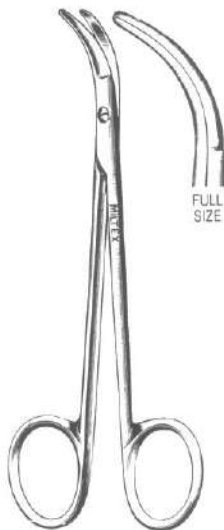

21-602



21-604



21-604TC

- 5-152 SISTRUNK Scissors 5½" (14 cm), heavy pattern, straight
- 5-154 SISTRUNK Scissors 5½" (14 cm), heavy pattern, slightly curved
- 21-600 FOMON Saber-Back Scissors 5" (12.7 cm), slightly curved blades with semi-sharp outer edges used for dissection
- 21-602 FOMON Lower Lateral Scissors 5" (12.7 cm), strong curve, dissecting blades
- 21-604 FOMON Dorsal Scissors 5½" (14 cm), light pattern, angular shanks
- 21-604TC FOMON Dorsal Scissors 5½" (14 cm), angular shanks, CARB-N-SERT blades, one serrated blade
- 21-605 MILTEX Saber-Back Rhytidectomy Scissors 6½" (16.5 cm), curved with semi-sharp outer edges used for dissection
- 21-606 CASTANARES Facelift Scissors 6¼" (15.9 cm), straight, short strong blades



21-605



21-606

For Carb-N-Sert Scissors with tungsten carbide blades see pages 55 - 59

For SuperCut Scissors see pages 60 - 63



21-607



21-608

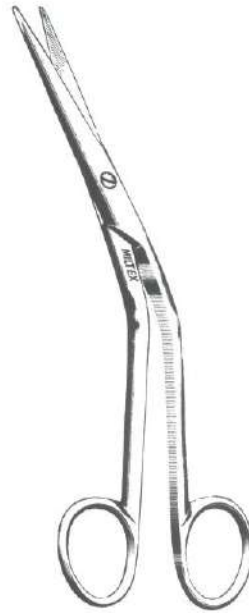

21-610

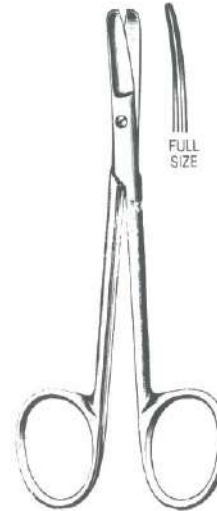

21-612



21-630
21-632

- 21-607 GORNEY Facelift Scissors 7¾" (19.7 cm), straight, one serrated blade
- 21-608 GORNEY Facelift Scissors 7¾" (19.7 cm), slightly curved, one serrated blade
- 21-610 COTTLE Dorsal Scissors 6½" (16.5 cm), heavy pattern with rounded blades, angular shanks
- 21-612 COTTLE Bulldog Nasal Scissors 4½" (11.4 cm), slightly curved blunt blades
- 21-630 JOSEPH Nasal Scissors 5¾" (14.6 cm), straight, sharp points
- 21-632 JOSEPH Nasal Scissors 5¾" (14.6 cm), curved, sharp points
- 21-621 GORNEY Septal Scissors 7¾" (19.7 cm), double action, angled handle, serrated blades with 1¾" (4.4 cm) cut
- 21-622 CAPLAN Nasal Bone Scissors 8" (20.3 cm), double action, serrated blades

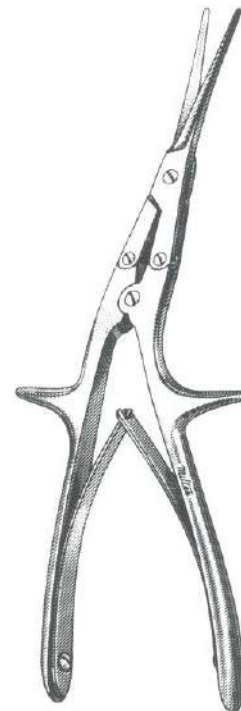

21-621

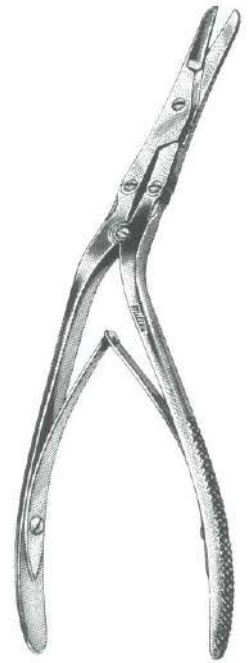

21-622

For Carb-N-Sert Scissors with tungsten carbide inserts see pages 55 - 59

For SuperCut Scissors see pages 60 - 63



21-624

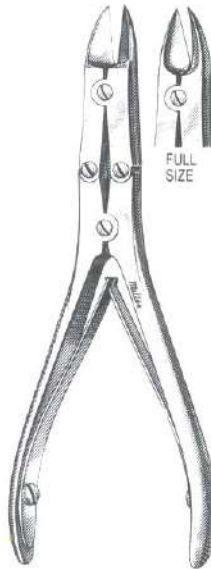

21-626
21-627

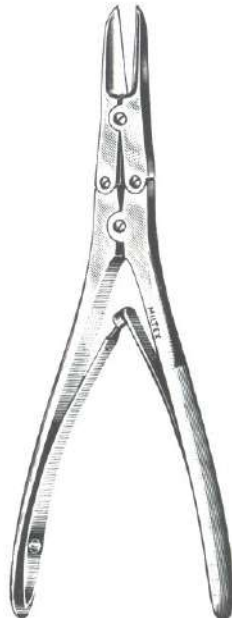

21-628



21-657



21-657 to 21-659



21-660



21-900

- 21-624 KAZANJIAN Nasal Cutting Forceps 7½" (19.1 cm), light model
- 21-626 KLEINERT-KUTZ (RUSKIN) Bone Cutting Forceps 6" (15.2 cm), straight
- 21-627 KLEINERT-KUTZ (RUSKIN) Bone Cutting Forceps 6" (15.2 cm), curved
- 21-628 RUSKIN (ROWLAND) Nasal Hump Forceps 7" (17.8 cm), double action, narrow jaws
- 21-657 WALSHAM Septum Straightener 9¼" (23.5 cm), Universal, with two convex blades
- 21-658 WALSHAM Septum Straightener 9¼" (23.5 cm), right, with one convex and one concave blade
- 21-659 WALSHAM Septum Straightener 9¼" (23.5 cm), left, with one convex and one concave blade
- 21-660 ASH Septum Straightener 9" (22.9 cm), angled blades flat inside
- 21-900 OBWEGESER Mandibular Awl for wire suturing 5½" (14 cm), slightly curved
- 21-901 OBWEGESER Mandibular Awl for wire suturing 7" (17.8 cm), strong curve
- 21-902 OBWEGESER Zygomatic Arch Awl for wire suturing 9" (22.9 cm), slightly curved



21-901



21-902



9-96

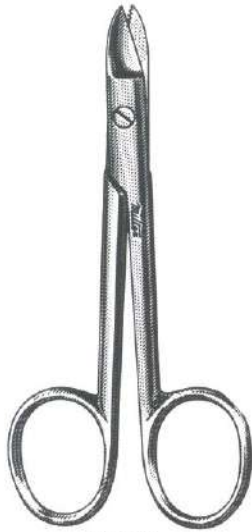

9-120
9D-121

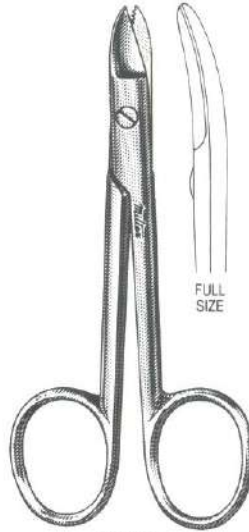

9-122
9D-123

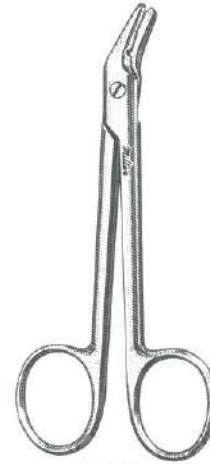

9-124



9-124TC

9-96 HEATH Wire Cutting Scissors 6¼" (15.9 cm), one serrated blade

WIRE CUTTING SCISSORS 4¾" (12.1 cm)

9-120 Straight, one serrated blade

9D-121 Straight

9-122 Curved, one serrated blade

9D-123 Curved

9-124 Angled to side, one serrated blade

9-124TC Angled to side, one serrated blade, Carb-N-Sert inserts

WIRE CUTTING SCISSORS 4¼" (10.8 cm)

9D-132 Straight, one serrated blade

9D-133 Straight

9D-134 Curved, one serrated blade

9D-135 Curved

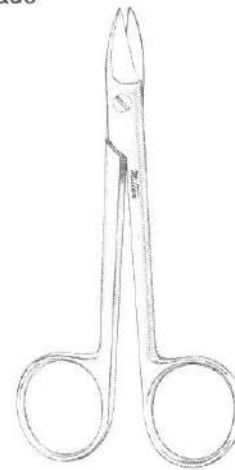

9D-132
9D-133

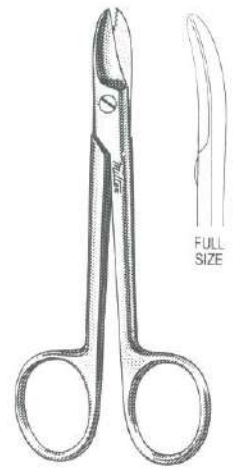

9D-134
9D-135



8-2



8-4



FULL SIZE

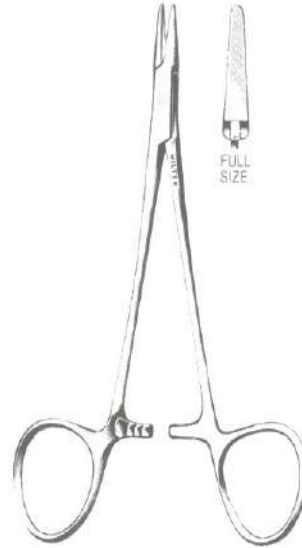

8-6



FULL SIZE



8-7



FULL SIZE

8-2 COLLIER Needle Holder 5" (12.7 cm), fenestrated jaws

8-4 DERF Needle Holder 4¾" (12.1 cm)

8-6 WEBSTER Needle Holder 5" (12.7 cm), delicate, smooth jaws, standard pattern

8-7 WEBSTER Needle Holder 4¾" (12.1 cm), extra delicate, smooth jaws

8-8 HALSEY Needle Holder 5" (12.7 cm), smooth jaws

8D-36 HALSEY Needle Holder 5" (12.7 cm), serrated jaws

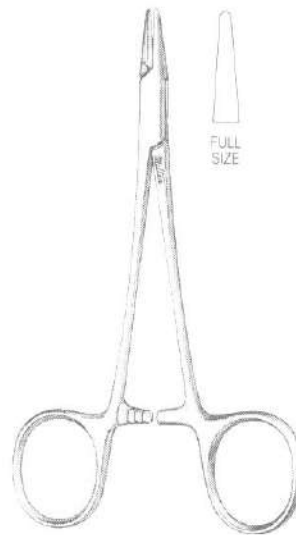

8-8



FULL SIZE

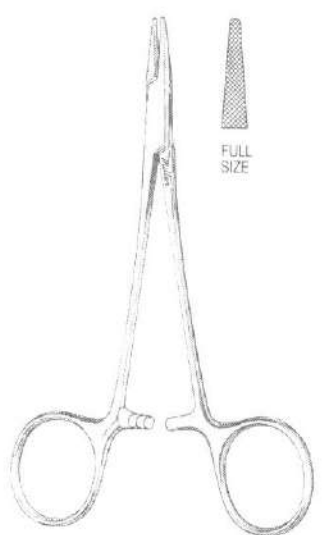

8D-36



FULL SIZE

For Carb-N-Sert Needle Holders with tungsten carbide inserts see pages 123 - 130

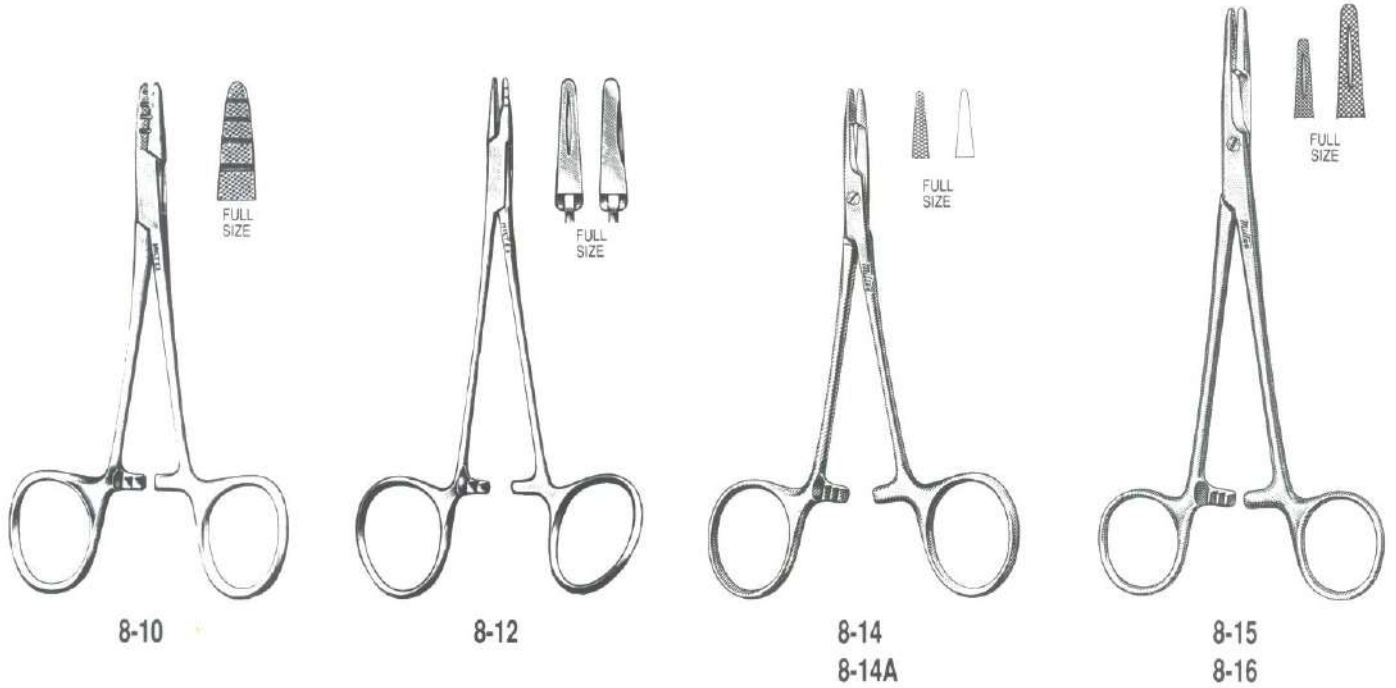

- 8-10 ABBEY Needle Holder 5" (12.7 cm)
- 8-12 NEIVERT Needle Holder 5" (12.7 cm), one offset ring
- OLSEN-HEGAR NEEDLE HOLDERS,
combined with Suture Scissors
- 8-14 4¾" (12.1 cm), Extra Delicate Pattern, serrated jaws
- 8-14A 4¾" (12.1 cm), Extra Delicate Pattern, smooth jaws
- 8-15 5½" (14 cm), serrated jaws
- 8-16 6½" (16.5 cm), serrated jaws
- 8-20 CONVERSE Needle Holder 4¼" (10.8 cm), longitudinal serrations, large finger rings



For Carb-N-Sert Needle Holders with tungsten carbide inserts see pages 123 - 130

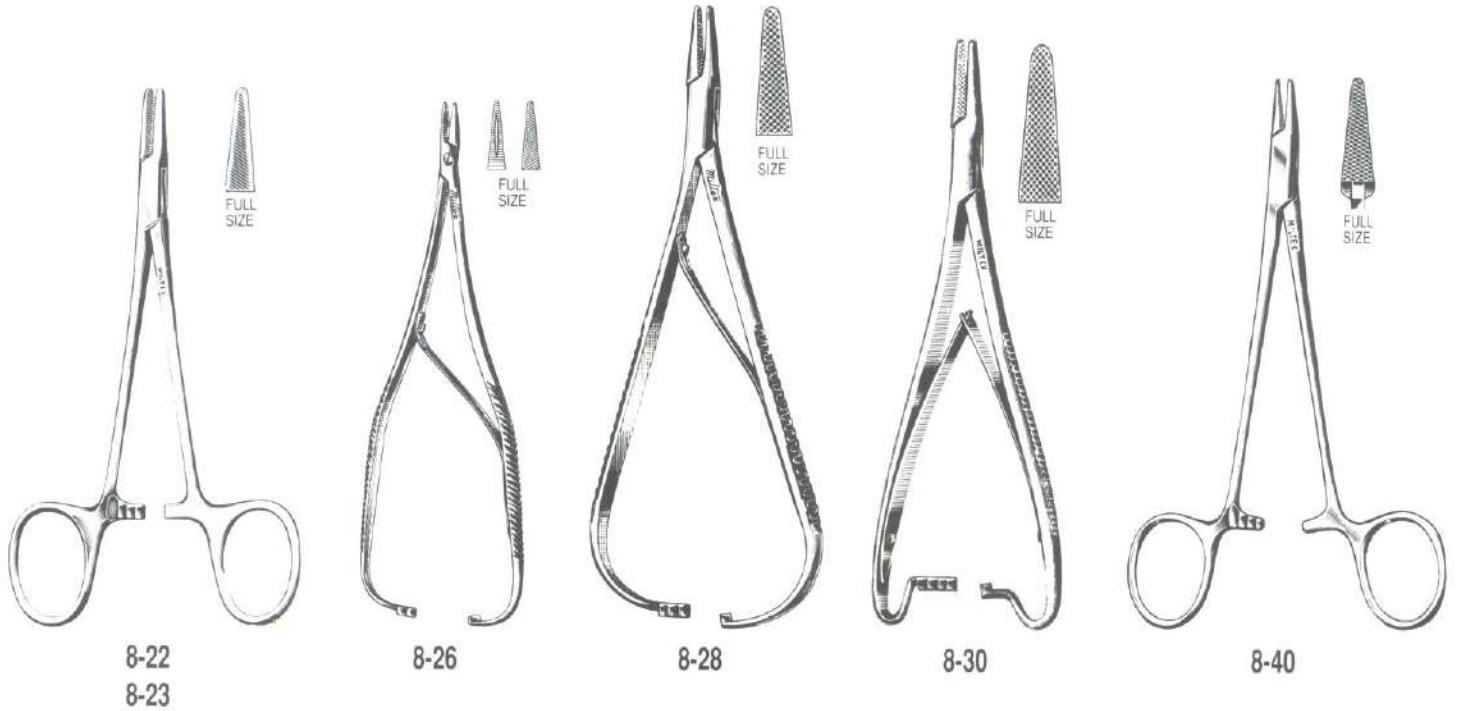

- 8-22 BROWN Needle Holder 5¼" (13.3 cm), convex jaws, fine serrations
- 8-23 BROWN Needle Holder 6¾" (17.1 cm), convex jaws, fine serrations
- 8-26 BOYNTON Needle Holder 5" (12.7 cm), delicate
- 8-28 MATHIEU Needle Holder 5½" (14 cm), with spring handles
- 8-30 MATHIEU Needle Holder 6¼" (15.9 cm), with spring handles
- 8-40 BAUMGARTNER Needle Holder 5½" (14 cm)
- 8-42 MAYO-HEGAR Needle Holder 5" (12.7 cm)
- 8-44 MAYO-HEGAR Needle Holder 6" (15.2 cm)
- 8-46 MAYO-HEGAR Needle Holder 7" (17.8 cm)

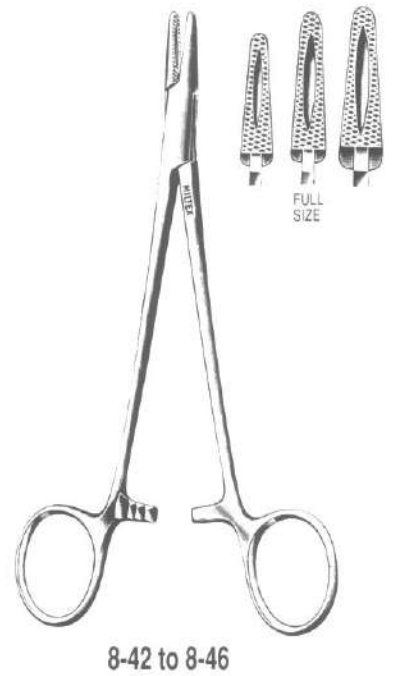

For Carb-N-Sert Needle Holders with tungsten carbide inserts see pages 123 - 130

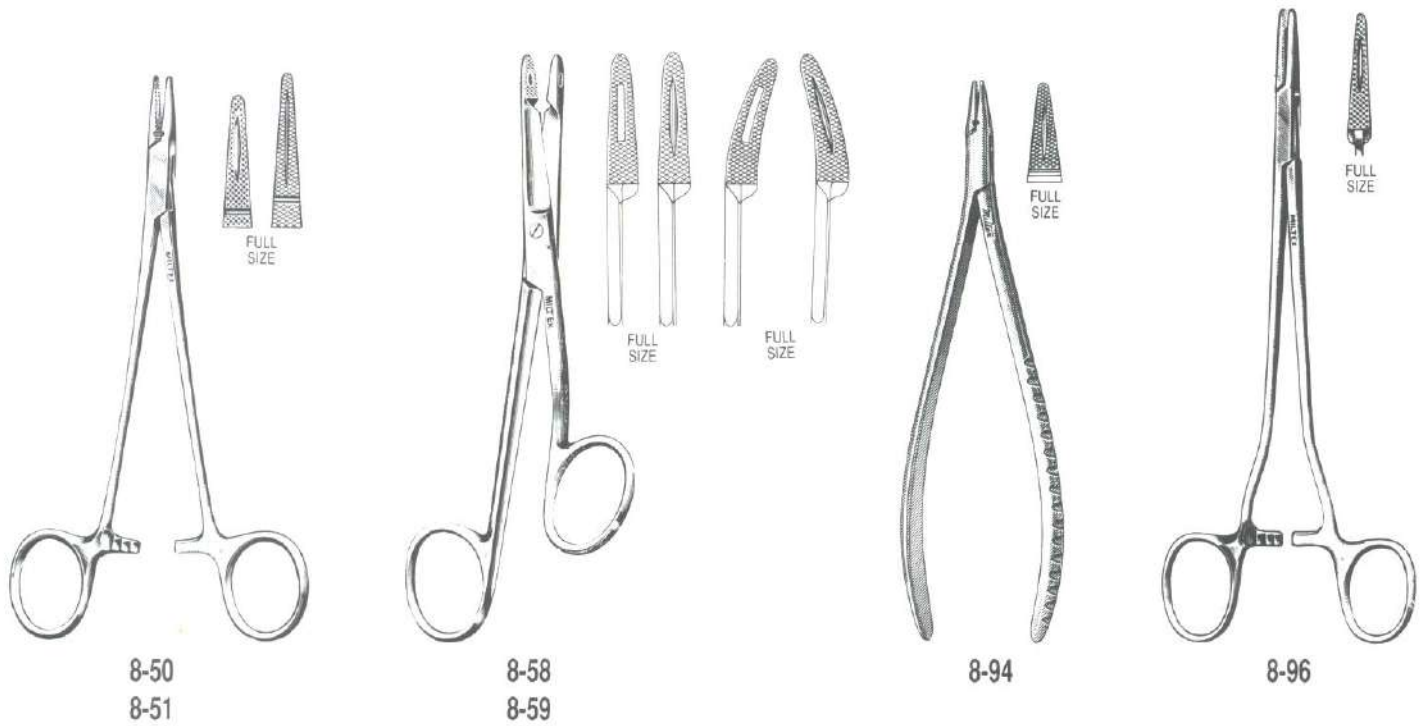

- 8-50 CRILE-WOOD Needle Holder 6" (15.2 cm)
- 8-51 CRILE-WOOD Needle Holder 7" (17.8 cm)
- 8-58 GILLIES-SHEEHAN Needle Holder, with Suture Scissors 6½" (16.5 cm), straight
- 8-59 GILLIES-SHEEHAN Needle Holder, with Suture Scissors 6½" (16.5 cm), curved
- 8-94 CRILE Needle Holder 6" (15.2 cm)
- 8-96 SAROT Needle Holder 7⅛" (18.1 cm), light model



17-1000



17-980
17-1010



17-1020



17-1024
17-1025

MILTEX Micro Surgery Needle Holders
with round handles, 0.6 mm tips

- | | |
|---------|---|
| 17-1000 | 5¼" (13.3 cm), curved jaws |
| 17-980 | 7⅞" (18.1 cm), straight jaws |
| 17-1010 | 7⅞" (18.1 cm), curved jaws |
| 17-1020 | 5¼" (13.3 cm), curved jaws, with lock |
| 17-1024 | 7⅞" (18.1 cm), straight jaws, with lock |
| 17-1025 | 7⅞" (18.1 cm), curved jaws, with lock |

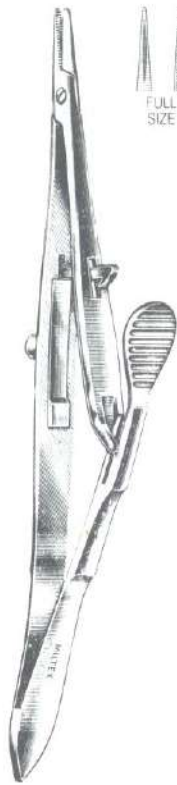

18-1800



18-1810

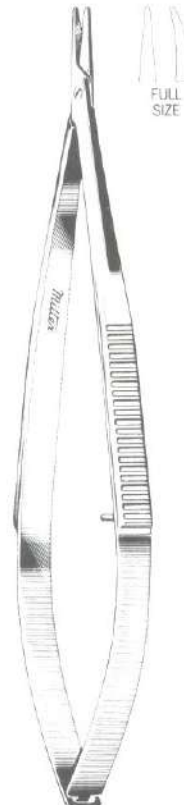

18-1820

18-1824



18-1828

18-1832

- 18-1800 KALT Needle Holder 5¼" (13.3 cm), standard model, delicate jaws
- 18-1810 GREEN Needle Holder and Suture Forceps 4¼" (10.8 cm), angled jaws, double end
- 18-1820 CASTROVIEJO Needle Holder 5½" (14 cm), straight, without lock
- 18-1824 CASTROVIEJO Needle Holder 5½" (14 cm), curved, without lock
- 18-1828 CASTROVIEJO Needle Holder 5½" (14 cm), straight, with lock
- 18-1832 CASTROVIEJO Needle Holder 5½" (14 cm), curved, with lock

For Carb-N-Sert Needle Holders with tungsten carbide inserts see pages 123 - 130

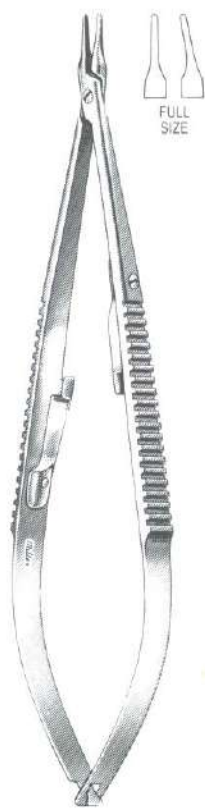

FULL
SIZE

18-1831
18-1833

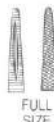
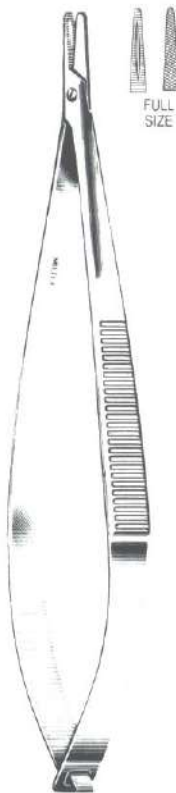

FULL
SIZE

18-1834

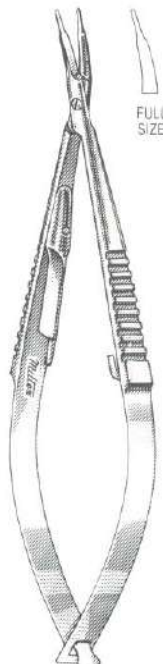

FULL
SIZE

18-1837

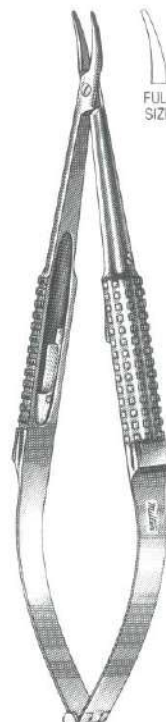

FULL
SIZE

18-1838
18-1839

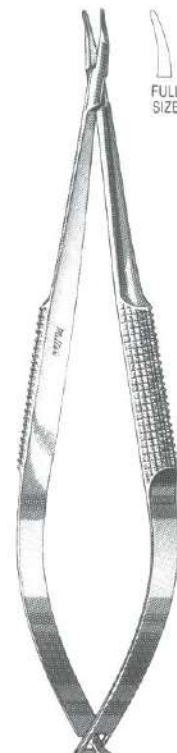

FULL
SIZE

18-1840

- 18-1831 CASTROVIEJO Needle Holder 5½" (14 cm), extra delicate jaws, straight, with lock
- 18-1833 CASTROVIEJO Needle Holder 5½" (14 cm), extra delicate jaws, curved, with lock
- 18-1834 PATON Needle Holder 4½" (11.4 cm), straight, without lock
- 18-1837 McPHERSON Needle Holder for microsurgery 4" (10.2 cm), curved smooth tapered jaws
- 18-1838 BARRAQUER Needle Holder 5" (12.7 cm), curved, without lock, 10 mm wide hollow round handle
- 18-1839 BARRAQUER Needle Holder 5" (12.7 cm), curved, with lock, 10 mm wide hollow round handle
- 18-1840 BARRAQUER Needle Holder 4¾" (12.1 cm), curved, without lock, delicate tapered jaws, 8 mm wide round handle

For Carb-N-Sert Needle Holders with tungsten carbide inserts see pages 123 - 130

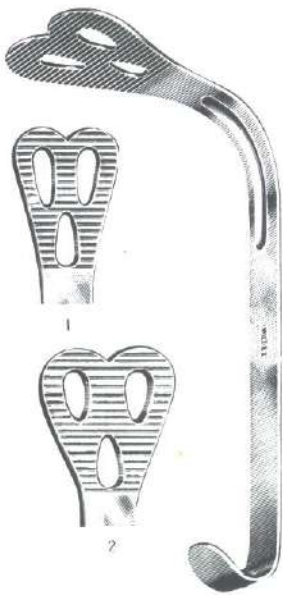

22-2
22-4



22-6



22-10



22-16



22-200

- 22-2 WIEDER Tongue Depressor, small blade 28 mm wide, serrated
- 22-4 WIEDER Tongue Depressor, large blade 36 mm wide, serrated
- 22-6 BOSWORTH Tongue Depressor, fenestrated blade 25 mm wide
- 22-10 ANDREWS Tongue Depressor, serrated blade 21 mm wide
- 22-16 Tongue Depressor 6¾" (17.1 cm), double end, 20 mm and 25 mm wide, cross serrated
- 22-200 MILTEX Lip Retractor 6" (15.2 cm), double end 25 mm and 36 mm wide
- 22D-202 COLUMBIA Lip Retractor 5½" (14 cm), double end 35 mm and 50 mm wide
- 22D-209 UNIVERSITY OF MINNESOTA Cheek Retractor 5½" (14 cm), double end 14 mm and 20 mm wide



22D-202



22D-209

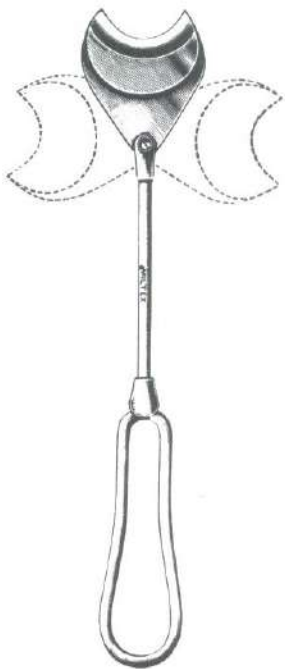

22-210

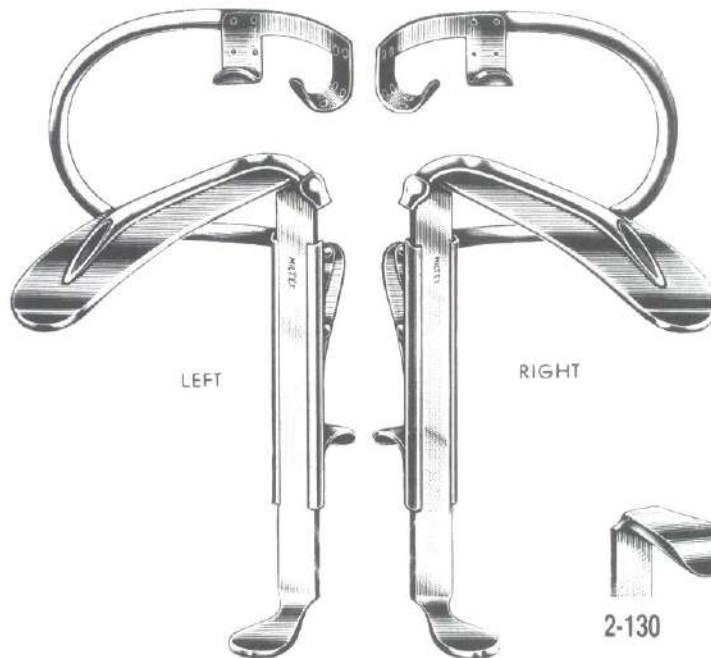

LEFT

RIGHT

2-130

2-120 to 2-122
2-132 to 2-138A

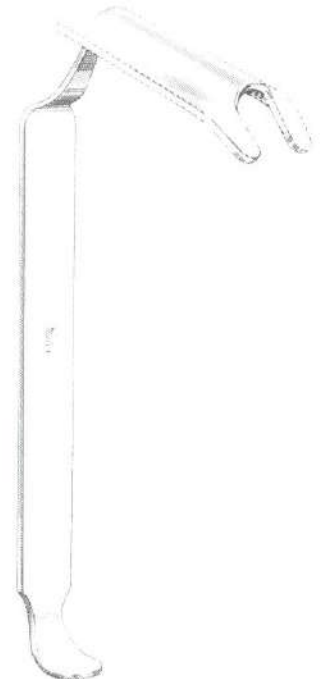

2-140 to 2-147

- 22-210** Cheek Retractor 7 $\frac{3}{4}$ " (19.7 cm), with swivel blade 35 mm wide
- 2-120** DAVIS Mouth Gag 6 $\frac{1}{4}$ " (15.9 cm), double bite, left, without blades
- 2-122** DAVIS Mouth Gag 6 $\frac{1}{4}$ " (15.9 cm), double bite, right, without blades

BLADES FOR DAVIS OR McIVOR MOUTH GAGS

W/o Ether Tube	Size No.	Size		W/Ether Tube
2-130	1	$\frac{3}{4}$ " x 1" (1.9 x 2.5 cm)	Tooth Plate	—
2-132	2	1" x 2 $\frac{3}{4}$ " (2.5 x 7 cm)	Tongue Blade	2-132A
2-134	3	1" x 3 $\frac{1}{4}$ " (2.5 x 8.3 cm)	Tongue Blade	2-134A
2-136	4	1" x 3 $\frac{3}{4}$ " (2.5 x 9.5 cm)	Tongue Blade	2-136A
2-138	5	1" x 4" (2.5 x 10.2 cm)	Tongue Blade	2-138A

RING TONGUE RETRACTOR BLADES

For use with Davis or McIvor Mouth Gags.
Grooved blade holds endotracheal tube firmly in place.

Left	Size No.	Size		Right
2-140	2	$\frac{7}{8}$ " x 2 $\frac{1}{4}$ " (2.2 x 5.7 cm)	Tooth Plate	2-144
2-141	3	1 $\frac{1}{8}$ " x 3" (2.9 x 7.6 cm)	Tongue Blade	2-145
2-142	4	1 $\frac{1}{4}$ " x 3 $\frac{1}{2}$ " (3.2 x 8.9 cm)	Tongue Blade	2-146
2-143	5	1 $\frac{1}{2}$ " x 3 $\frac{3}{4}$ " (3.8 x 9.5 cm)	Tongue Blade	2-147

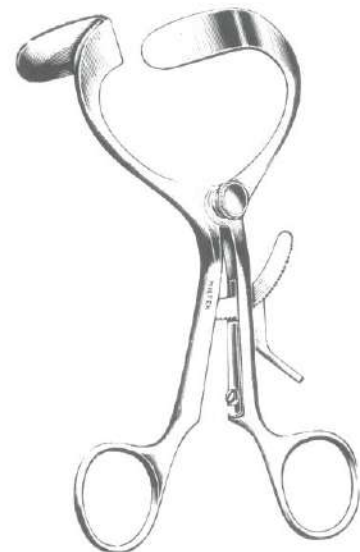

2-150

- 2-150** DOYEN-JANSEN Mouth Gag 5 $\frac{1}{2}$ " (14 cm), with grip lock



2-180



2-160 to 2-164

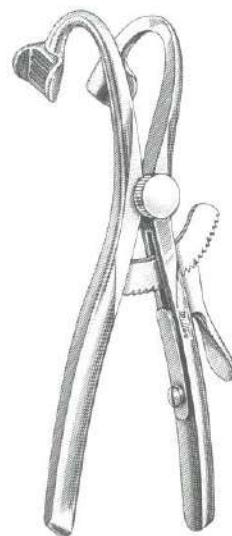

2-154

2-180 McIVOR Mouth Gag 5¾" (14.6 cm), complete with 3 tongue blades, one each Nos. 2-132, 2-134 and 2-136.

2-182 McIVOR Mouth Gag 5¾" (14.6 cm), frame only

2-160 JENNINGS Mouth Gag, adult size, 6" (15.2 cm) wide

2-162 JENNINGS Mouth Gag, child size, 4¾" (12.1 cm) wide

2-164 JENNINGS Mouth Gag, infant size, 3¾" (9.5 cm) wide

2-154 DENHARDT Mouth Gag 5¾" (14.6 cm), improved model, with grip lock

MOLT Mouth Gags
with silicone guards

63-10 Pediatric 4" (10.2 cm)

63-15 Child 4½" (11.4 cm)

63-20 Adult 5½" (14 cm)

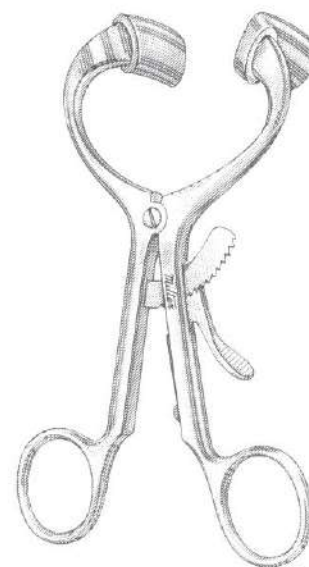

63-10 to 63-20



2-20



2-50

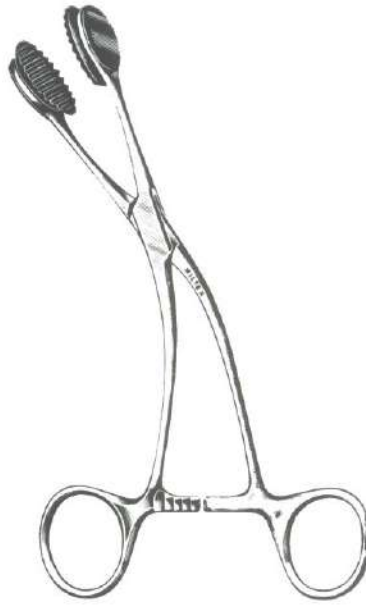

2-60
2-62



2-100

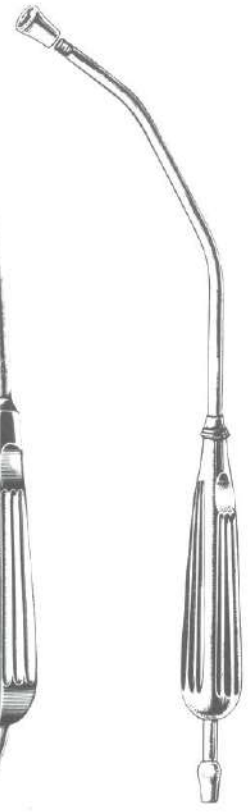

2-104
2-104SS

- 2-20 MAUNDER Oral Screw, white plastic
- 2-50 COLLIN Tongue Seizing Forceps 6¾" (17.1 cm), jaws 25 mm wide
- 2-60 YOUNG Tongue Seizing Forceps 6½" (16.5 cm), with soft rubber jaws
- 2-62 Rubber Jaws for YOUNG Tongue Forceps
- 2-100 PYNCHON Suction Tube 11" (27.9 cm), tip with large openings, with removable tubing connection, chrome
- 2-104 YANKAUER Suction Tube 11¾" (29.8 cm), with removable tip and tubing connection, chrome
- 2-104SS YANKAUER Suction Tube 11¾" (29.8 cm), with removable tip and tubing connection
- 2-106 Tip for YANKAUER Suction Tube, chrome
- 2-106SS Tip for YANKAUER Suction Tube
- 2-109 YANKAUER Pediatric Suction Tube 8½" (21.6 cm), with removable tip, delicate pattern



2-106
2-106SS

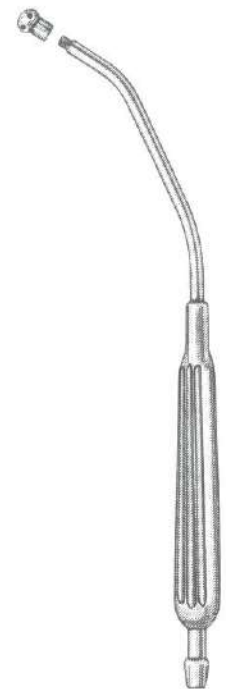

2-109



2-110
2-110SS

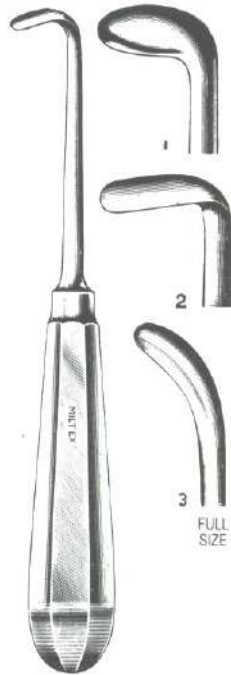

22-300 to 22-304



18-1968



5-316



5-318
5D-326

- 2-110 ANDREWS-PYNCHON Suction Tube 10" (25.4 cm), delicate pattern, chrome
- 2-110SS ANDREWS-PYNCHON Suction Tube 10" (25.4 cm), delicate pattern
- 22-300 BLAIR Cleft Palate Elevator 7¾" (19.7 cm), L-Shape, blunt
- 22-302 BLAIR Cleft Palate Elevator 7¾" (19.7 cm), right angle, semi-sharp tip
- 22-304 BLAIR Cleft Palate Elevator 8" (20.3 cm), curved blade, blunt
- 18-1968 FREER Elevator 7" (17.8 cm), double end, sharp and blunt blades 5 mm wide
- 5-316 BROPHY Scissors 5½" (14 cm), straight, sharp points
- 5-318 BROPHY Scissors 5½" (14 cm), curved, sharp points
- 5D-326 BROPHY Scissors 5½" (14 cm), curved, one serrated blade
- 9-106 LONG Oral Surgery Stitch Scissors 6" (15.2 cm)

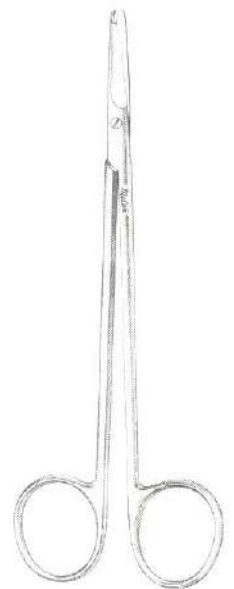

9-106

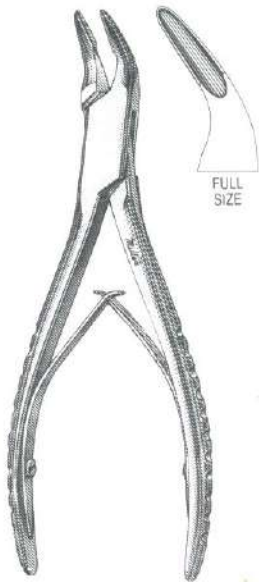

22D-420

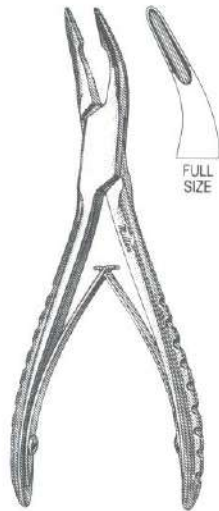

22D-422

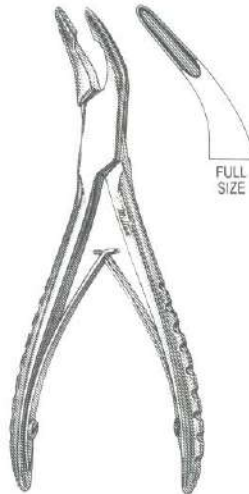

22D-424

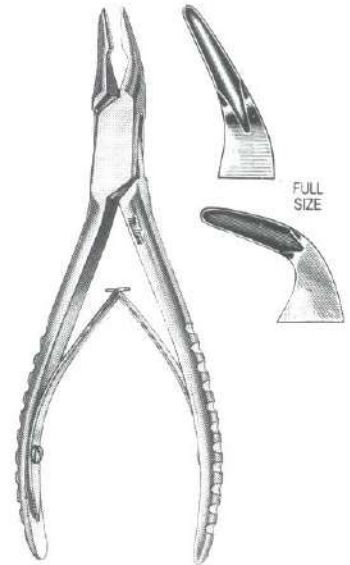

22-480 to 22-482

22D-420 BLUMENTHAL Oral Surgery Rongeur 6" (15.2 cm), beaks at 45° angle

22D-422 Mini-BLUMENTHAL Oral Surgery Rongeur 4½" (11.4 cm), beaks at 30° angle

22D-424 Mini-BLUMENTHAL Oral Surgery Rongeur 4½" (11.4 cm), beaks at 45° angle

22-480 BLUMENTHAL Oral Surgery Rongeur 6" (15.2 cm), beaks at 30° angle

22-481 BLUMENTHAL Oral Surgery Rongeur 7" (17.8 cm), beaks at 30° angle

22-482 BLUMENTHAL Oral Surgery Rongeur 6" (15.2 cm), beaks at 90° angle

22-484 MEAD Oral Surgery Rongeur 6½" (16.5 cm), No. 1A pattern, slightly angled beaks

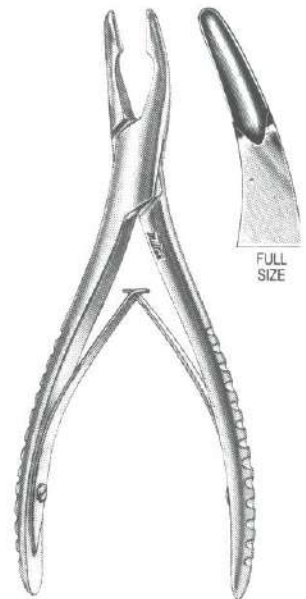

22-484

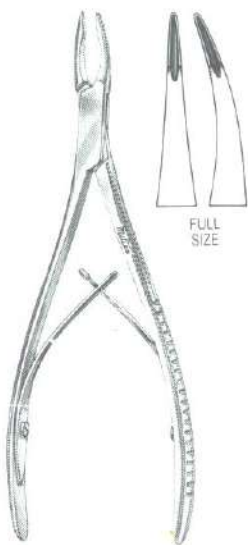

17-4800
17-4801

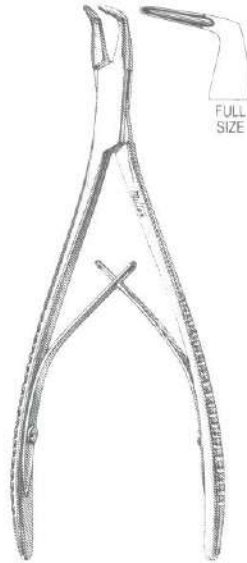

17D-4802

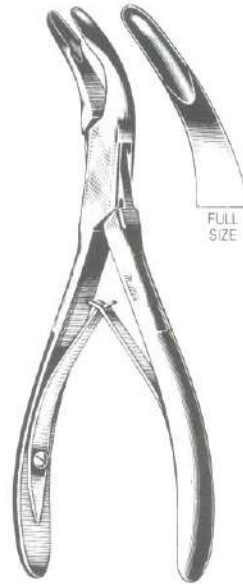

19-804

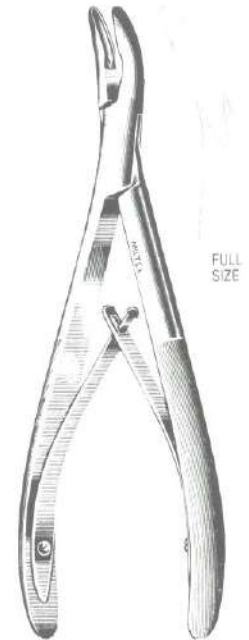

19-808

- 17-4800 Micro-FRIEDMAN Rongeur 5½" (14 cm), straight 1.3 mm wide jaws, very delicate
- 17-4801 Micro-FRIEDMAN Rongeur 5½" (14 cm), curved 1.3 mm wide jaws, very delicate
- 17D-4802 Micro-FRIEDMAN Rongeur 5½" (14 cm), 90° angled 1.3 mm wide jaws, very delicate
- 19-804 HARTMAN Rongeur 5¾" (14.6 cm), strong curve
- 19-808 BANE Rongeur 7" (17.8 cm), slight curve
- 19-844 BEYER Rongeur, double action, 7" (17.8 cm), slight curve
- 22-494 FRIEDMAN Oral Surgery Rongeur 5½" (14 cm), very delicate, slightly curved beaks



19-844

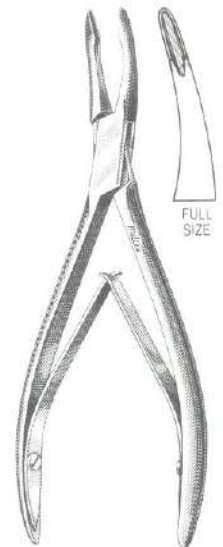

22-494

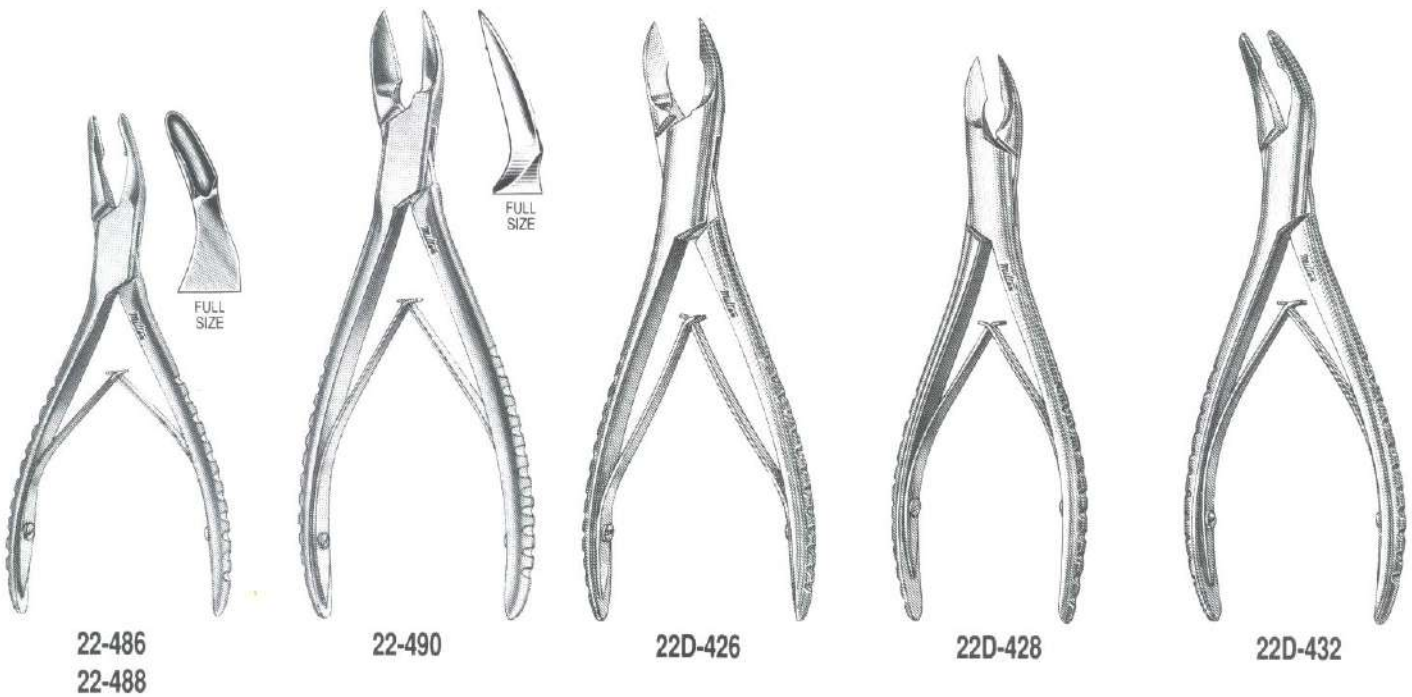

- 22-486** Oral Surgery Rongeur 5½" (14 cm), No. 4 pattern, slightly curved beaks
- 22-488** Oral Surgery Rongeur 6½" (16.5 cm), No. 4A pattern, slightly curved beaks
- 22-490** Oral Surgery Rongeur 6¾" (17.1 cm), No. 5 pattern, side cutting, slightly curved
- 22D-426** Oral Surgery Rongeur 6½" (16.5 cm), No. 5A pattern, side cutting, slightly curved
- 22D-428** Oral Surgery Rongeur 6" (15.2 cm), No. 5S pattern, side cutting, slightly curved
- 22D-432** Oral Surgery Rongeur 6½" (16.5 cm), No. 1 pattern, strong curved beaks
- 22-492** Oral Surgery Rongeur 6½" (16.5 cm), No. 6A pattern, end cutting, curved beaks

- 22-500TC** Wire Twister 6" (15.2 cm), with Carb-N-Sert jaws
- 22-502TC** Wire Twister 8" (20.3 cm), with Carb-N-Sert jaws

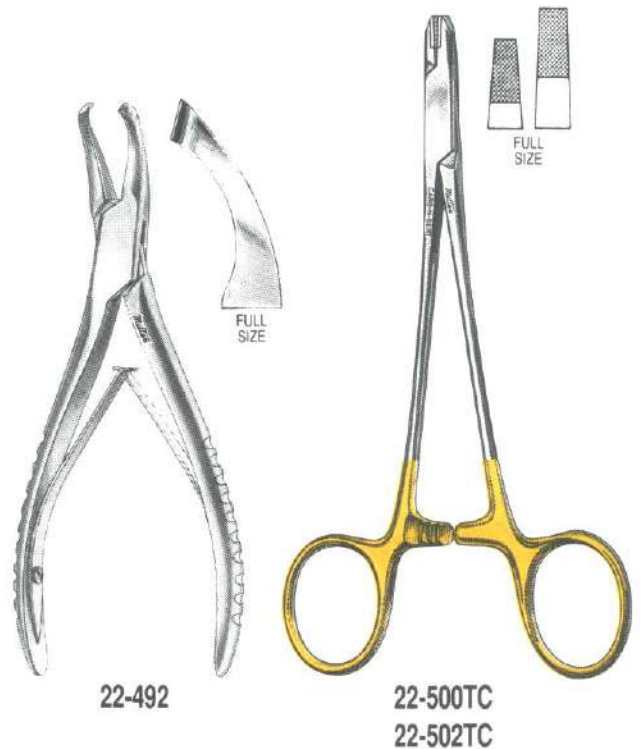



22-550
22-552

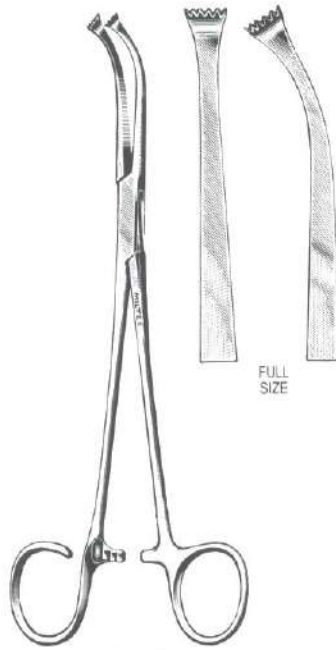

22-556
22-558



22-560

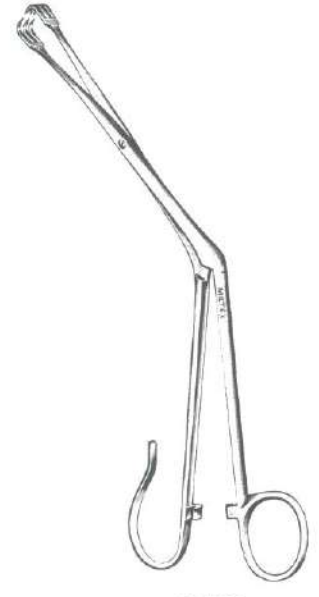

22-586

- 22-550 WHITE Tonsil Seizing Forceps 7½" (19.1 cm), medium curve, open ring
- 22-552 WHITE Tonsil Seizing Forceps 9½" (24.1 cm), medium curve, open ring
- 22-556 COLVER Tonsil Seizing Forceps 7½" (19.1 cm), straight, open ring
- 22-558 COLVER Tonsil Seizing Forceps 7½" (19.1 cm), medium curve, open ring
- 22-560 BALLENGER Tonsil Seizing Forceps 8½" (21.6 cm), slight curve, 3 x 3 prongs, open ring
- 22-586 TIVNEN Tonsil Seizing Forceps 8" (20.3 cm), angled 3 x 3 prongs, open ring



7-604
7-606



7-614
7-616



7-190

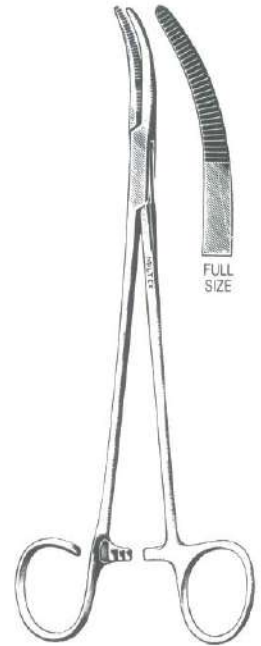

22-660

- 7-604 BALLINGER Sponge Forceps 7" (17.8 cm), straight, serrated loop jaws
- 7-606 BALLINGER Sponge Forceps 7" (17.8 cm), straight, smooth loop jaws
- 7-614 BALLINGER Sponge Forceps 7" (17.8 cm), curved, serrated loop jaws
- 7-616 BALLINGER Sponge Forceps 7" (17.8 cm), curved, smooth loop jaws
- 7-190 MICULICZ Tonsil Hemostatic Forceps 7½" (19.1 cm), slight curve, 1 x 2 teeth
- 22-660 SCHNIDT Tonsil Hemostatic Forceps 7½" (19.1 cm), slight curve, open ring
- 22-662 SCHNIDT Tonsil Hemostatic Forceps 7½" (19.1 cm), slight curve, closed rings



22-662

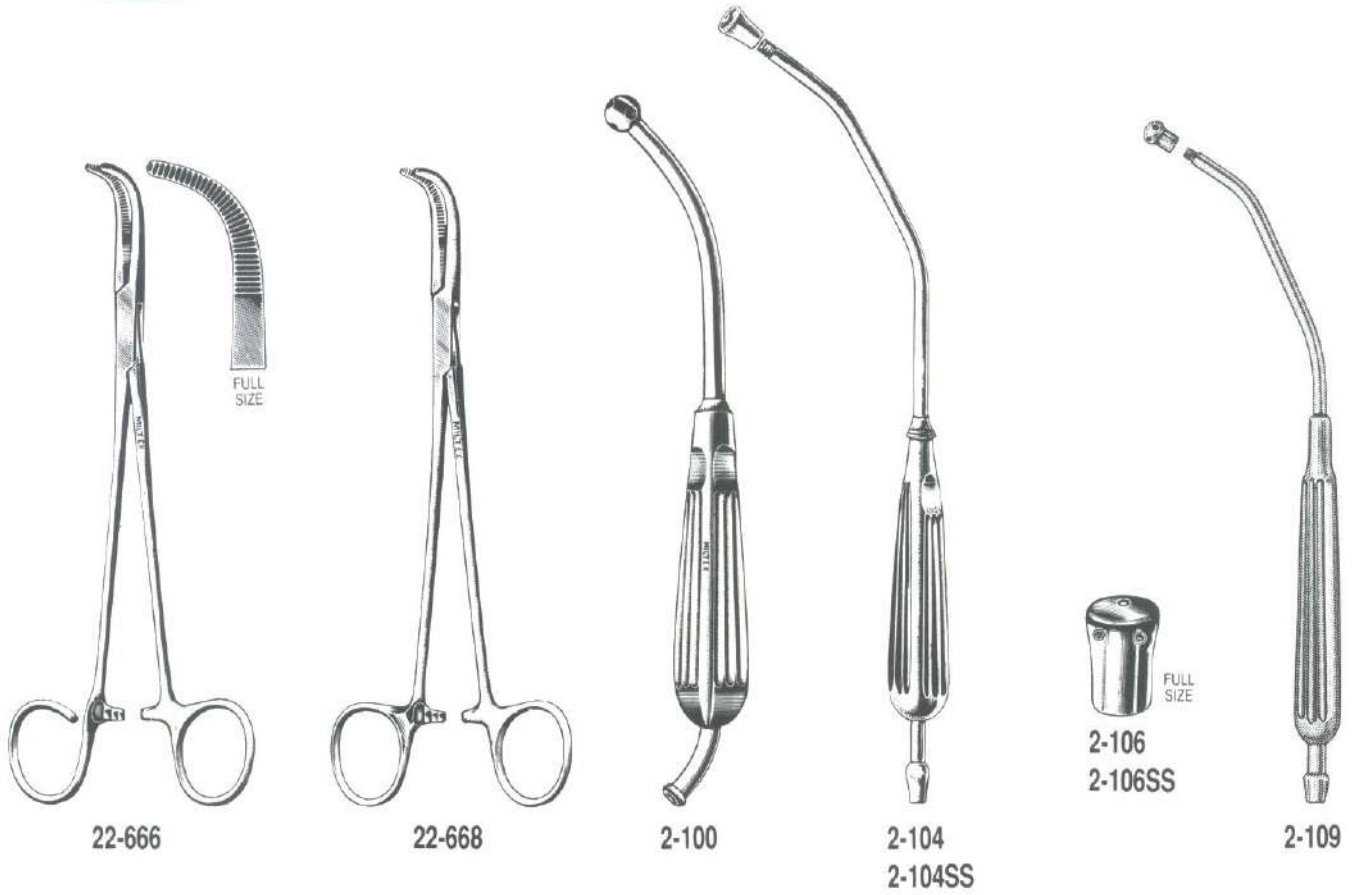

- 22-666** SAWTELL Tonsil Hemostatic Forceps 7½" (19.1 cm), full curve, open ring
- 22-668** SAWTELL Tonsil Hemostatic Forceps 7½" (19.1 cm), full curve, closed rings
- 2-100** PYNCHON Suction Tube 11" (27.9 cm), tip with large openings, with removable tubing connection, chrome
- 2-104** YANKAUER Suction Tube 11¾" (29.8 cm), with removable tip and tubing connection, chrome
- 2-104SS** YANKAUER Suction Tube 11¾" (29.8 cm), with removable tip and tubing connection
- 2-106** Tip for YANKAUER Suction Tube, chrome
- 2-106SS** Tip for YANKAUER Suction Tube
- 2-109** YANKAUER Pediatric Suction Tube 8½" (21.6 cm), with removable tip, delicate pattern
- 2-110** ANDREWS-PYNCHON Suction Tube 10" (25.4 cm), delicate pattern, chrome
- 2-110SS** ANDREWS-PYNCHON Suction Tube 10" (25.4 cm), delicate pattern

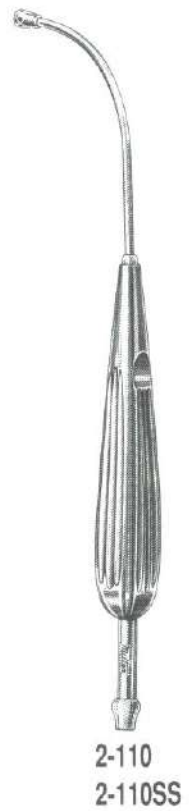

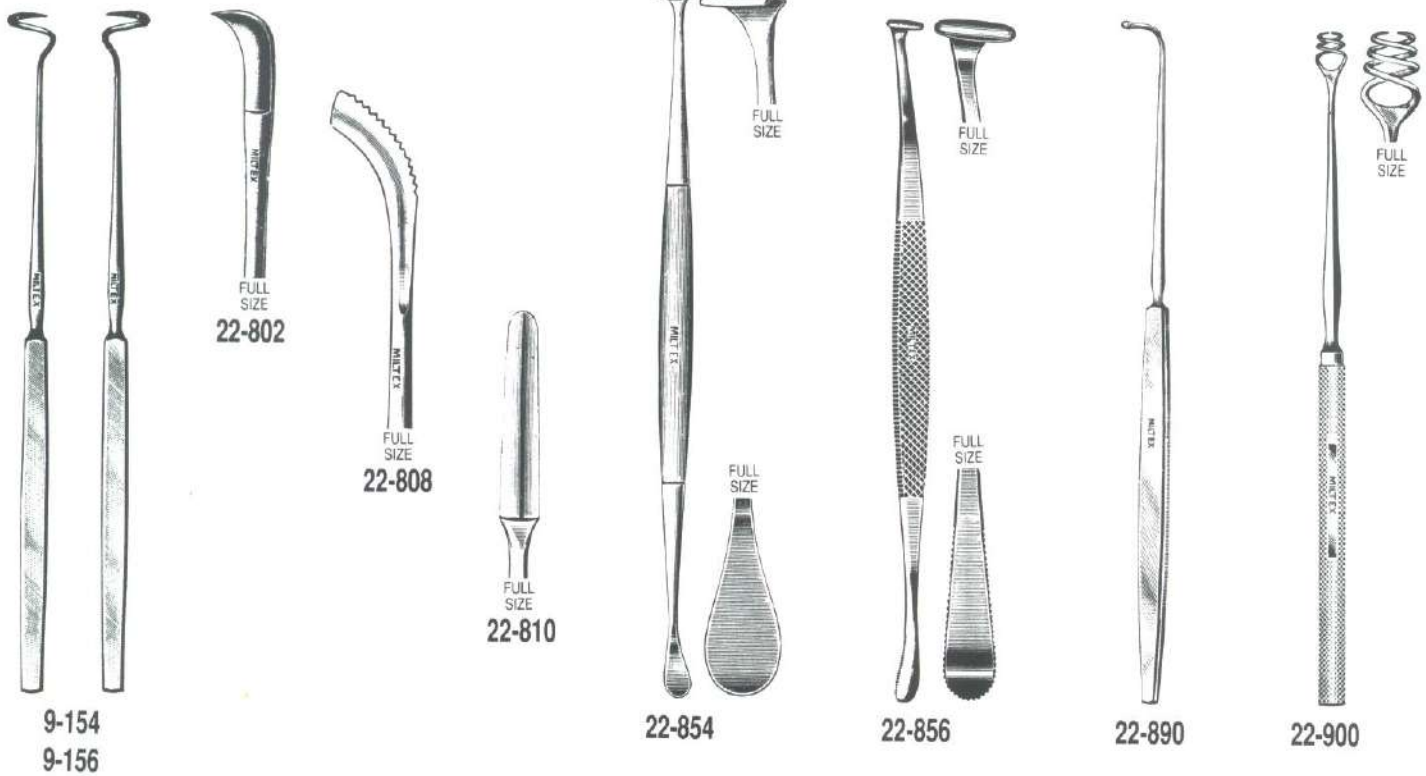

- 9-154 DUPUYSS-WEISS Ligature Needle 8½" (21.6 cm), right
- 9-156 DUPUYSS-WEISS Ligature Needle 8½" (21.6 cm), left
- 22-802 CANFIELD Tonsil Knife 8½" (21.6 cm), curved
- 22-808 FISHER Tonsil Knife and Dissector 8½" (21.6 cm), sharp tip
- 22-810 DEAN Tonsil Knife 7½" (19.1 cm), straight, double edge
- 22-854 HURD Tonsil Dissector and Pillar Retractor 9" (22.9 cm), standard pattern,
9 x 25 mm blade
- 22-856 MORRISON-HURD Tonsil Dissector and Pillar Retractor 9" (22.9 cm), flat handle,
8 x 25 mm serrated blade
- 22-890 COLVER Tonsil Examining Retractor 8" (20.3 cm), blunt tip
- 22-900 LEWIS Tonsil Screw 7¾" (19.7 cm), two sharp points, standard small size



5-182



5-288



22-962

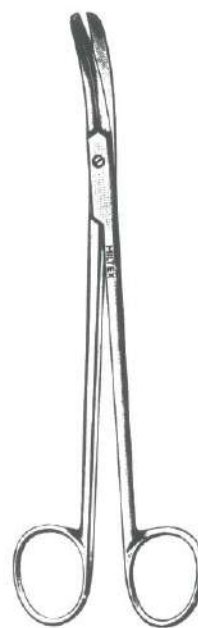

5-256

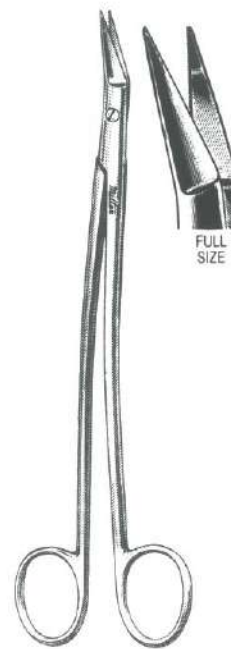

5-264

- 5-182 METZENBAUM Tonsil Scissors 7" (17.8 cm), curved, standard pattern
- 5-288 METZENBAUM Tonsil Scissors 7" (17.8 cm), curved, delicate pattern
- 22-962 LILLY Tonsil Scissors 7½" (19.1 cm), strong curve
- 5-256 BOETTCHER Tonsil Scissors 7¼" (18.4 cm), curved
- 5-264 DEAN Tonsil Scissors 6¾" (17.1 cm), blades angled on flat, one serrated blade

For Carb-N-Sert and SuperCut Metzenbaum Scissors see pages 57 and 61.



22-1000



22-1002

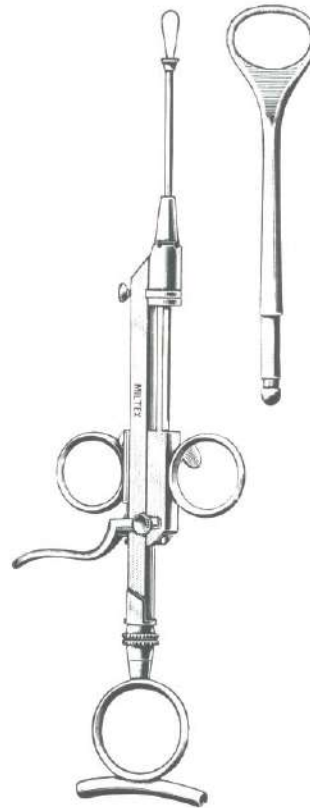

22-1010 to 22-1020

- 22-1000** EVE Tonsil Snare 11" (27.9 cm), standard model, without ratchet
- 22-1002** EVE Tonsil Snare 11" (27.9 cm), with ratchet
- 22-1010** BECK-SCHENCK Tonsil Snare 10" (25.4 cm), complete with one straight and one vedder tip
- 22-1016** Medium Vedder Tip, opening 23 x 19 mm
- 22-1020** Straight Tip 2½" (6.4 cm) for BECK-SCHENCK Tonsil Snare
- 22-1030** SAGE Automatic Ratchet Tonsil Snare, improved pattern, with removable straight tip

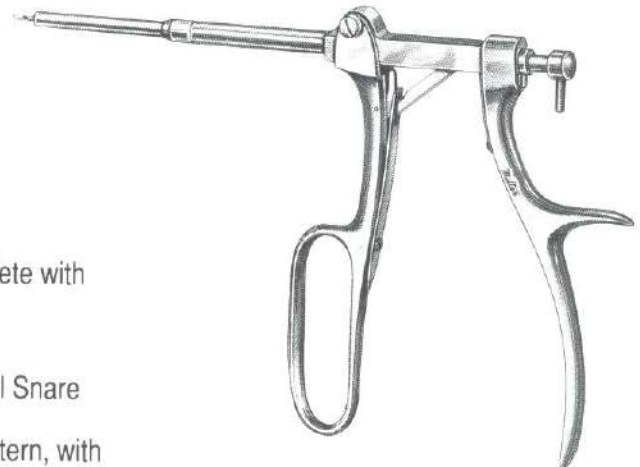

22-1030

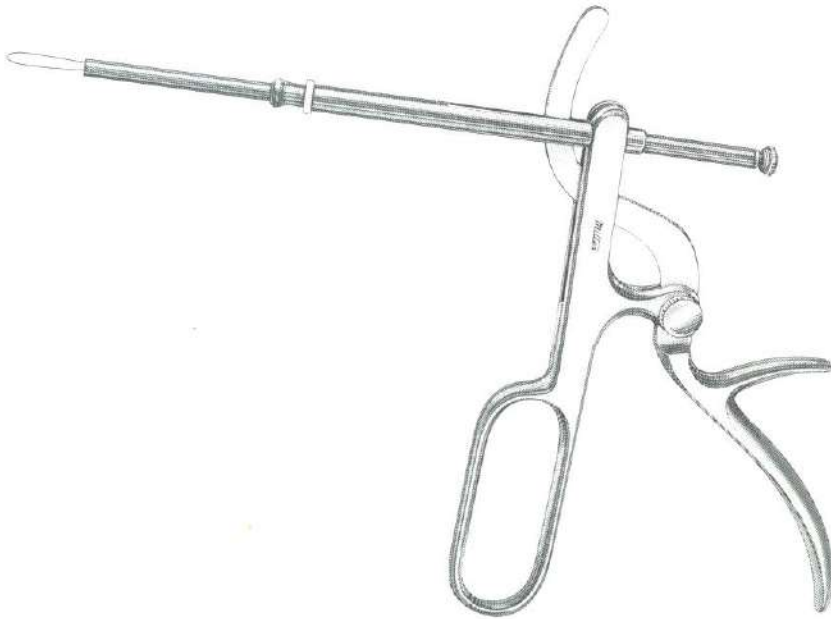

22-1041
22-1042



22-1052

22-1060

22-1041 TYDING Tonsil Snare, complete with straight tip
22-1042 Straight Tip for TYDING Snare

22-1052 HARTMAN Tonsil Punch, 4½" (11.4 cm) shaft, 9 mm round cut, with basket

*TONSIL SNARE WIRE,
pre-cut 4" (10.2 cm), bent ends

22-1060-6	Size 6	22-1060-8	size 8
22-1060-7	Size 7	22-1060-9	size 9

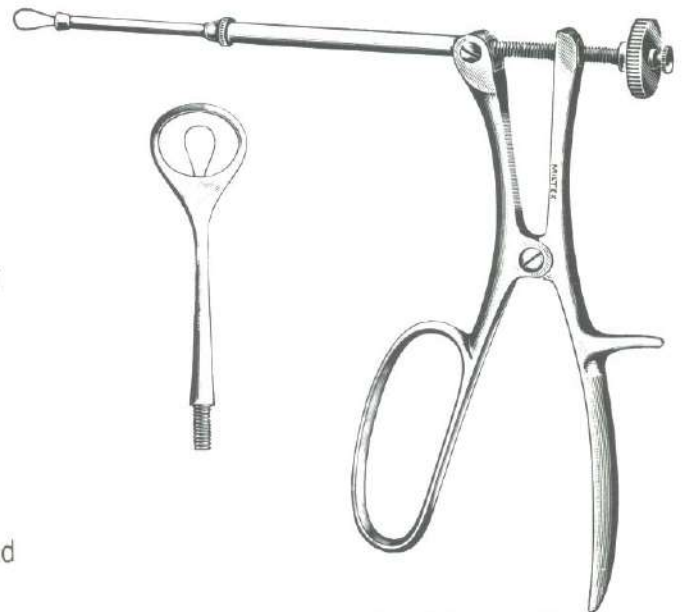

22-1070 to 22-1074

22-1070 BROWN Tonsil Snare, complete with one straight and one vedder tip

22-1072 Straight tip for BROWN Snare

22-1074 Vedder Tip 23 x 19 mm opening, for BROWN Snare

*For Snare Wire Sizes 4 and 5 see page 294



23-1 to 23-18

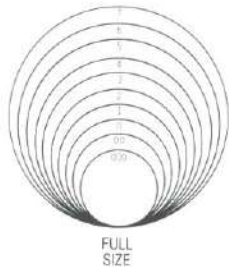

23-1 to 23-46



23-29 to 23-46



23-60



23-62

LARYNGEAL MIRRORS, Boilable, Thin Model

Complete with octagon threaded handle	Size No.	Diameter	Mirror only with threaded stem
23-1-000	000	10 mm	23-29-000
23-2-00	00	12 mm	23-30-00
23-4-0	0	14 mm	23-32--0
23-6-1	1	16 mm	23-34-1
23-8-2	2	18 mm	23-36-2
23-10-3	3	20 mm	23-38-3
23-12-4	4	22 mm	23-40-4
23-14-5	5	24 mm	23-42-5
23-16-6	6	26 mm	23-44-6
23-18-7	7	28 mm	23-46-7

- 23-60 Octagon Threaded Handle for Laryngeal Mirrors
- 23-62 UNIVERSAL Chuck Handle for Laryngeal Mirrors, round, chrome

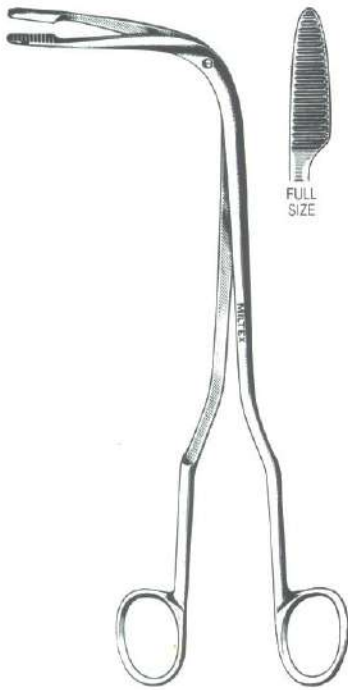

23-150

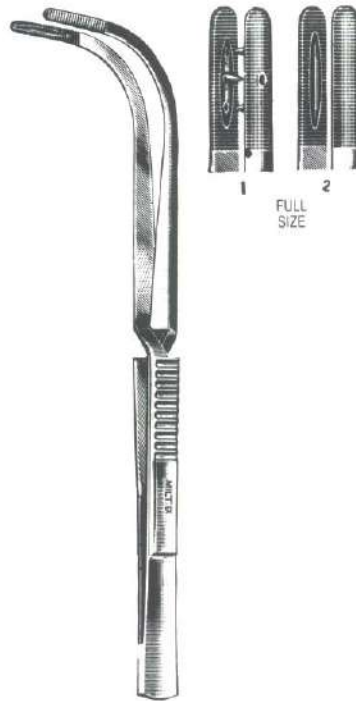

23-160

23-162



23-200

23-150 FRAENKEL Laryngeal Forceps 9" (22.9 cm), serrated jaws

23-160 JACKSON Laryngeal Forceps 9½" (24.1 cm), cross action, serrated jaws with 1 x 2 teeth, 3 mm wide

23-162 JACKSON Laryngeal Forceps 9½" (24.1 cm), cross action, serrated jaws 3 mm wide

23-200 IVAN Laryngeal Applicator 8½" (21.6 cm), curved, triangular end

23-230 FRAENKEL Laryngeal Forceps 9" (22.9 cm), alligator type, lower jaw opening, 12 x 3 mm cups

23-232 FRAENKEL Laryngeal Forceps 9" (22.9 cm), alligator type, jaw opening to right side, 12 x 3 mm cups

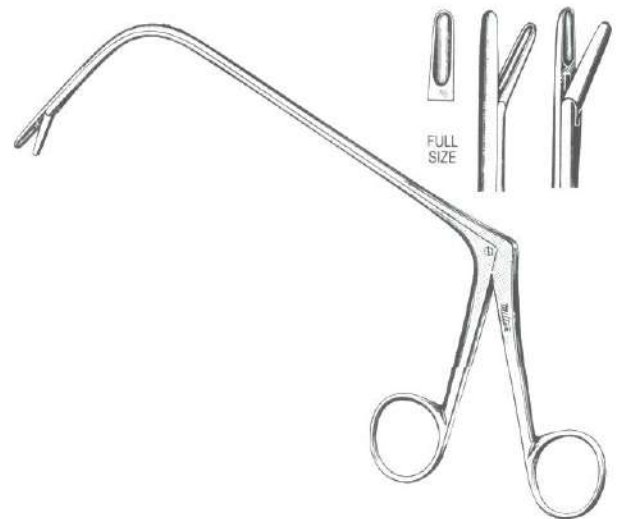

23-230

23-232



23-282



23-286



23-320
23-322

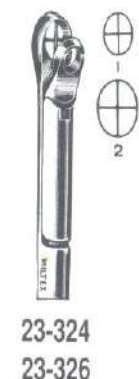

23-324
23-326



23-399 to 23-402

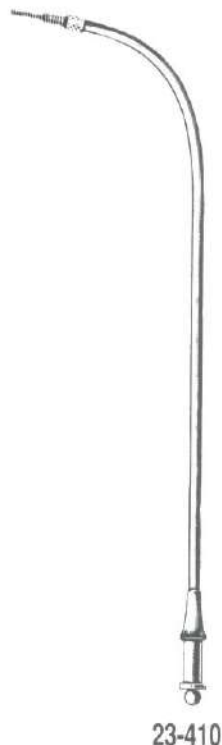

23-410

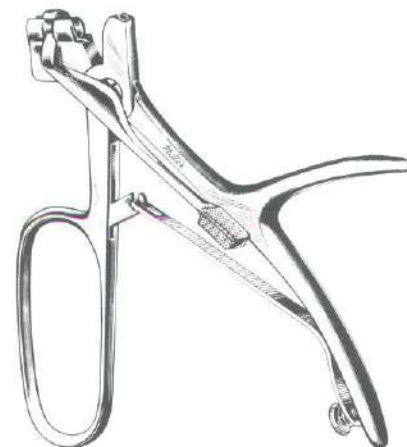

23-420

UNIVERSAL LARYNGEAL TIPS for use with
Nos. 23-399 to 23-410 Cannula and No. 23-420 Handle

- 23-282 BRUENING Cup Jaws, 3 mm round, straight
- 23-286 Cup Jaws, 3 mm round, angled-up-
- 23-320 KRAUSE Square Basket Jaws, through-cutting, small, straight
- 23-322 KRAUSE Square Basket Jaws, through-cutting, large, straight
- 23-324 KRAUSE Oval Basket Jaws, through-cutting, small, straight
- 23-326 KRAUSE Oval Basket Jaws, through-cutting, large, straight

UNIVERSAL CANNULA for use with
Laryngeal Tips and Universal Handles

- 23-399 15 cm straight
- 23-400 20 cm straight
- 23-402 30 cm straight
- 23-410 20 cm curved

- 23-420 UNIVERSAL Handle for use with all Cannula and Tips

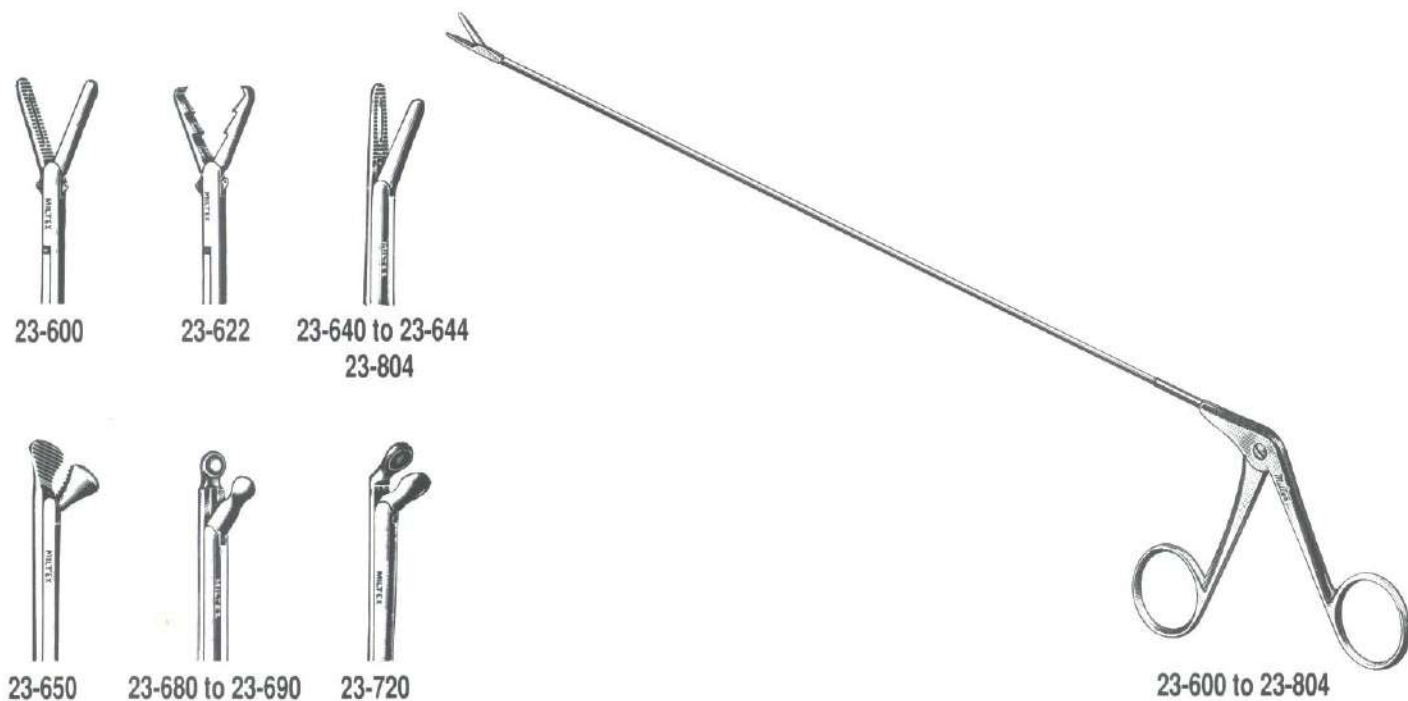

BRONCHOSCOPIC FORCEPS Double Articulated Jaws

- | | |
|---------------|---|
| 23-600 | Serrated Grasping Jaws, 30 cm shaft, 4 mm pass diameter |
| 23-622 | KAHLER Alligator Grasping Jaws, 40 cm shaft, 4 mm pass diameter |
| 23-640 | Serrated Jaws 3 x 12 mm, 30 cm shaft, 4 mm pass diameter |
| 23-642 | Serrated Jaws 3 x 12 mm, 40 cm shaft, 4 mm pass diameter |
| 23-644 | Serrated Jaws 3 x 12 mm, 50 cm shaft, 4 mm pass diameter |
| 23-650 | Papilloma Grasping Jaws 7 mm wide, with fine serrations, 30 cm shaft |
| 23-680 | JACKSON Cup Jaws 2 mm dia. straight, 30 cm shaft |
| 23-690 | JACKSON Cup Jaws 4 mm dia. straight, 30 cm shaft |
| 23-720 | JACKSON Cup Jaws 4 mm dia. angular, 30 cm shaft |
| 23-804 | Serrated Jaws 2 x 8 mm, Miniature size, 20 cm shaft, 3 mm pass diameter |

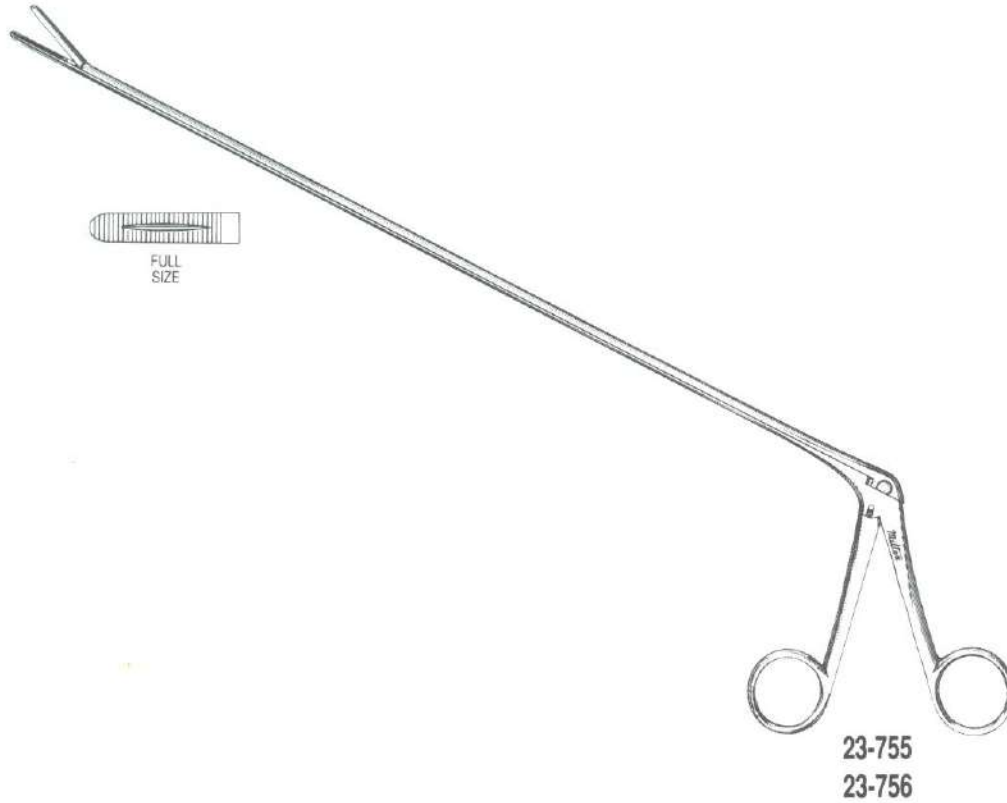

JACKSON ENDOSCOPIC FORCEPS, Standard Pattern

- 23-755** Serrated Grasping Jaws 4 x 20 mm, 30 cm shaft, passes 5 mm tube
- 23-756** Serrated Grasping Jaws 4 x 20 mm, 30 cm shaft, passes 5 mm tube



23-1007



23-1047



23-1048



23-1049



23-1050



23-1051

- 23-1007** HUPP Trachea Retractor 6" (15.2 cm), 3 sharp prongs 12 mm wide, and probe end 35 mm long
- 23-1047** LUKENS Trachea Retractor 6¾" (17.1 cm), 10 mm wide curved and 7 mm wide angular blades
- 23-1048** HUPP Trachea Hook 6½" (16.5 cm), sharp point
- 23-1049** JACKSON Trachea Retractor 7" (17.8 cm), double end, 2 blunt prongs 5/16" (2.4 cm) wide, and solid blade 3/8" (1 cm) wide
- 23-1050** JACKSON Trachea Tenaculum 5¾" (14.6 cm), sharp point
- 23-1051** NEWS Tracheotomy Hook 6" (15.2 cm), sharp point

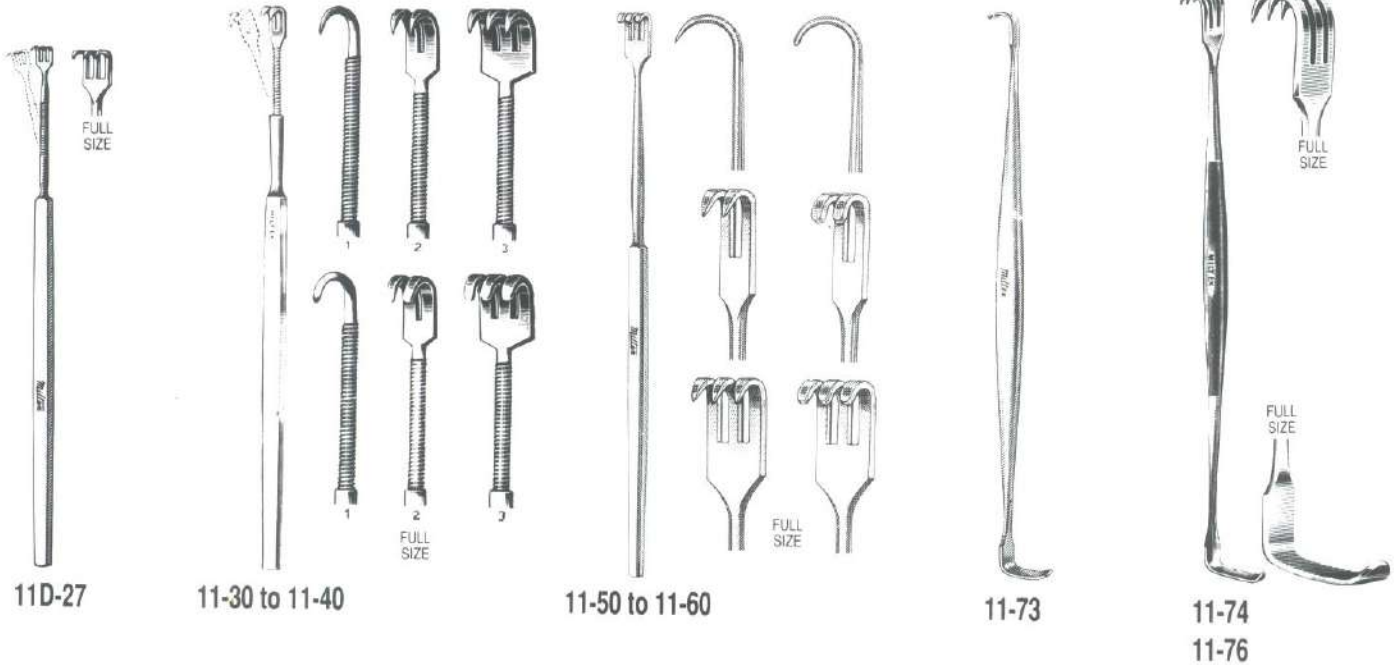

11D-27 Trachea Retractor 5" (12.7 cm), with Flexible Neck, 3 sharp prongs

TRACHEA RETRACTORS 6" (15.2 cm), with Flexible Neck

11-30	Sharp	1 Prong	11-36	Blunt
11-32	Sharp	2 Prongs	11-38	Blunt
11-34	Sharp	3 Prongs	11-40	Blunt

TRACHEA RETRACTORS 6" (15.2 cm), with Rigid Neck

11-50	Sharp	1 Prong	11-56	Blunt
11-52	Sharp	2 Prongs	11-58	Blunt
11-54	Sharp	3 Prongs	11-60	Blunt

11-73 RAGNELL Retractor 6" (15.2 cm), double end 3 x 8 mm and 5 x 15 mm blades, delicate

11-74 SENN Retractor 6 $\frac{3}{8}$ " (16.2 cm), sharp, double end

11-76 SENN Retractor 6 $\frac{3}{8}$ " (16.2 cm), blunt, double end

11-80 MATHIEU Retractor 6 $\frac{1}{2}$ " (16.5 cm), sharp, double end

11-81 MATHIEU Retractor 6 $\frac{1}{2}$ " (16.5 cm), blunt, double end

11-82 MEYERDING Skin Hook and Retractor 6 $\frac{1}{4}$ " (15.9 cm), double end

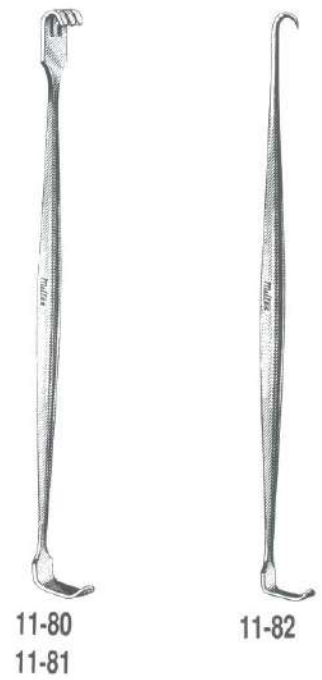

11-80
11-81

11-82



23-1060



23-1402

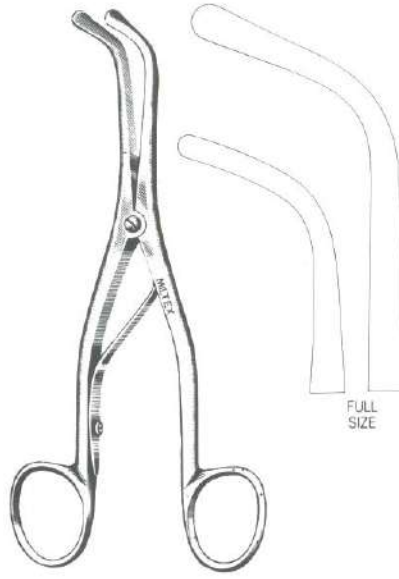



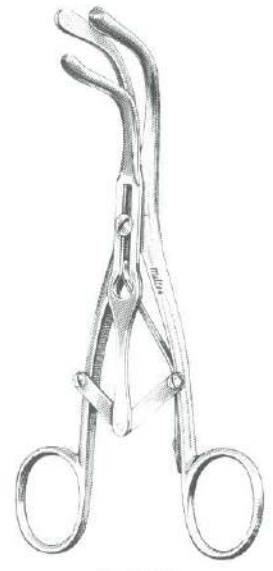









23-1420
23-1421



23-1430

- 23-1060** JACKSON Trachea Bistouri 6½" (16.5 cm), curved blade 2" (5.1 cm), long, with probe tip
- 23-1402** MOSHER Life Saving Tube 8" (20.3 cm) size 20 Fr. (6.6 mm)
- 23-1420** TROUSSEAU Trachea Dilator 5¼" (13.3 cm), standard size, jaws 3 cm long x 5 mm wide at tip
- 23-1421** TROUSSEAU Trachea Dilator 4½" (11.4 cm), neo natal size, jaws 2 cm long x 3 mm wide at tip
- 23-1430** LaBORDE Trachea Dilator 5½" (14 cm), three bladed

TRACHEA & LARYNGECTOMY TUBE DIMENSIONS

Size	Actual Size	O.D. mm	Cat. No. 23-1139SS to 23-1219SS	Cat. No. 23-1243SS to 23-1251SS	Cat. No. 23-1350SS to 23-1352SS	Cat. No. 23-1360ST and 23-1361ST
00		3	1 $\frac{3}{4}$ " (4.4 cm)			
0		4	2" (5.1 cm)			
1		5	2 $\frac{1}{4}$ " (5.7 cm)			
2		6	2 $\frac{1}{2}$ " (6.4 cm)	2 $\frac{1}{4}$ " (5.7 cm)		
3		7	2 $\frac{3}{4}$ " (7 cm)	2 $\frac{3}{8}$ " (5.4 cm)		
4		8	3" (7.6 cm)	2 $\frac{1}{2}$ " (6.4 cm)		
5		9	3 $\frac{3}{8}$ " (8.6 cm)	2 $\frac{5}{8}$ " (6.7 cm)		
6		10	3 $\frac{1}{2}$ " (8.9 cm)	2 $\frac{7}{8}$ " (7.3 cm)		
7		11	3 $\frac{3}{4}$ " (9.5 cm)	3" (7.6 cm)		2 $\frac{1}{2}$ " (6.4 cm)
8		12	4" (10.2 cm)	3 $\frac{1}{8}$ " (7.9 cm)	2 $\frac{1}{4}$ " (5.7 cm)	2 $\frac{3}{4}$ " (7 cm)
9		13	4 $\frac{1}{8}$ " (10.5 cm)	3 $\frac{1}{4}$ " (8.3 cm)		
10		14	4 $\frac{1}{8}$ " (10.5 cm)	3 $\frac{3}{8}$ " (8.6 cm)	2 $\frac{1}{4}$ " (5.7 cm)	
12		16			2 $\frac{1}{4}$ " (5.7 cm)	

Length in inches and centimeters measured on outside curve



23-1139 to 23-1159



23-1199 to 23-1251

JACKSON TRACHEA TUBES, Improved Model with Rotating Lock

23-1139SS	Size 00	23-1150SS	Size 5
23-1140SS	Size 0	23-1152SS	Size 6
23-1142SS	Size 1	23-1154SS	Size 7
23-1144SS	Size 2	23-1156SS	Size 8
23-1146SS	Size 3	23-1158SS	Size 9
23-1148SS	Size 4	23-1159SS	Size 10

JACKSON TRACHEA TUBES, Regular Length, Original Model with Wing Lock

23-1199SS	Size 00	23-1210SS	Size 5
23-1200SS	Size 0	23-1212SS	Size 6
23-1202SS	Size 1	23-1214SS	Size 7
23-1204SS	Size 2	23-1216SS	Size 8
23-1206SS	Size 3	23-1218SS	Size 9
23-1208SS	Size 4	23-1219SS	Size 10

JACKSON TRACHEA TUBES, Short Length, Original Model with Wing Lock

23-1243SS	Size 2	23-1248SS	Size 7
23-1244SS	Size 3	23-1249SS	Size 8
23-1245SS	Size 4	23-1250SS	Size 9
23-1246SS	Size 5	23-1251SS	Size 10
23-1247SS	Size 6		



23-1350 to 23-1352

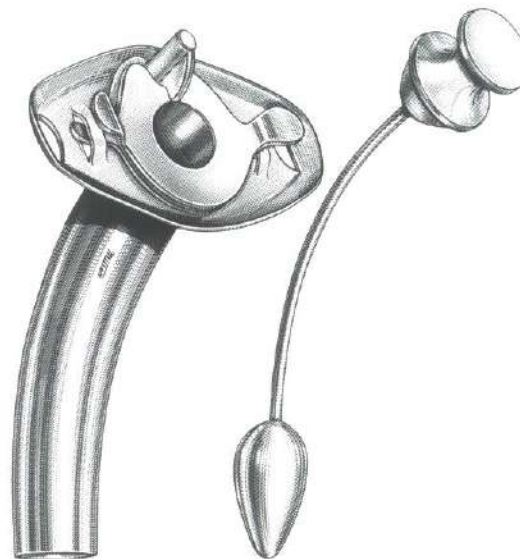

23-1360
23-1361

- 23-1350SS MARTIN Laryngectomy Tube, Size 8
- 23-1351SS MARTIN Laryngectomy Tube, Size 10
- 23-1352SS MARTIN Laryngectomy Tube, Size 12
- 23-1360ST LEWIS Laryngectomy Tube, Size 7, tapered, sterling
- 23-1361ST LEWIS Laryngectomy Tube, Size 8, tapered, sterling

CLEANING BRUSHES for Trachea and Laryngectomy Tubes
Nylon Bristles with Stainless Wire Handles

- 23-1600 Small Brush for tube sizes 2 to 5, overall length 6" (15.2 cm)
- 23-1602 Large Brush for tube sizes 6 to 12, overall length 8" (20.3 cm)

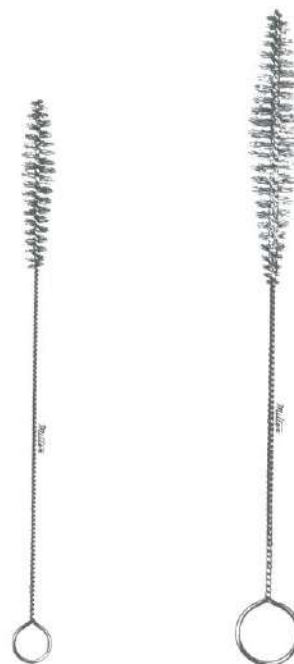

23-1600

23-1602

Enlarged cross sections of our basic patterns:

DeBakey type serration

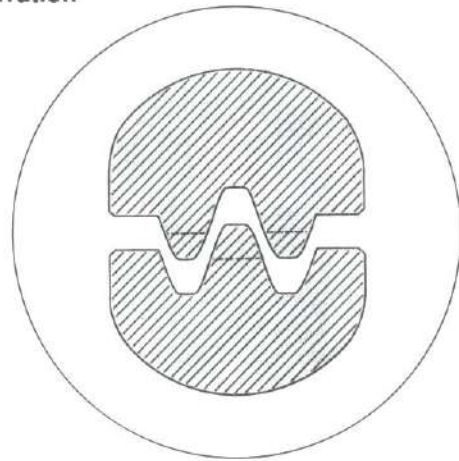

Cooley type serration

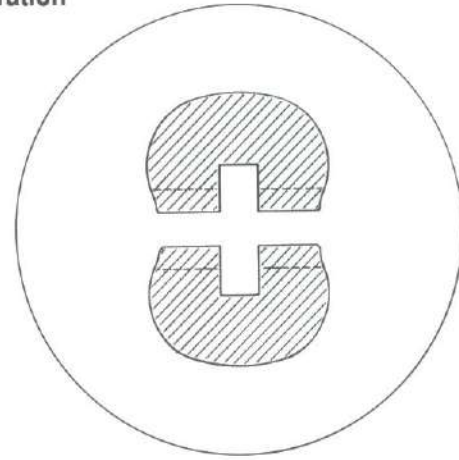

Manufactured in the Miltex tradition, these high quality instruments feature:

- Individual hand finishing assures soft spring action of the handles and perfect balance
- A scientific milling process produces an exclusive design on the atraumatic clamping surfaces, providing fine serrations that are of non-traumatic quality, but that will grip the tissue firmly
- Basic jaw types include the DeBakey type and the Cooley type

Atraumatic Forceps

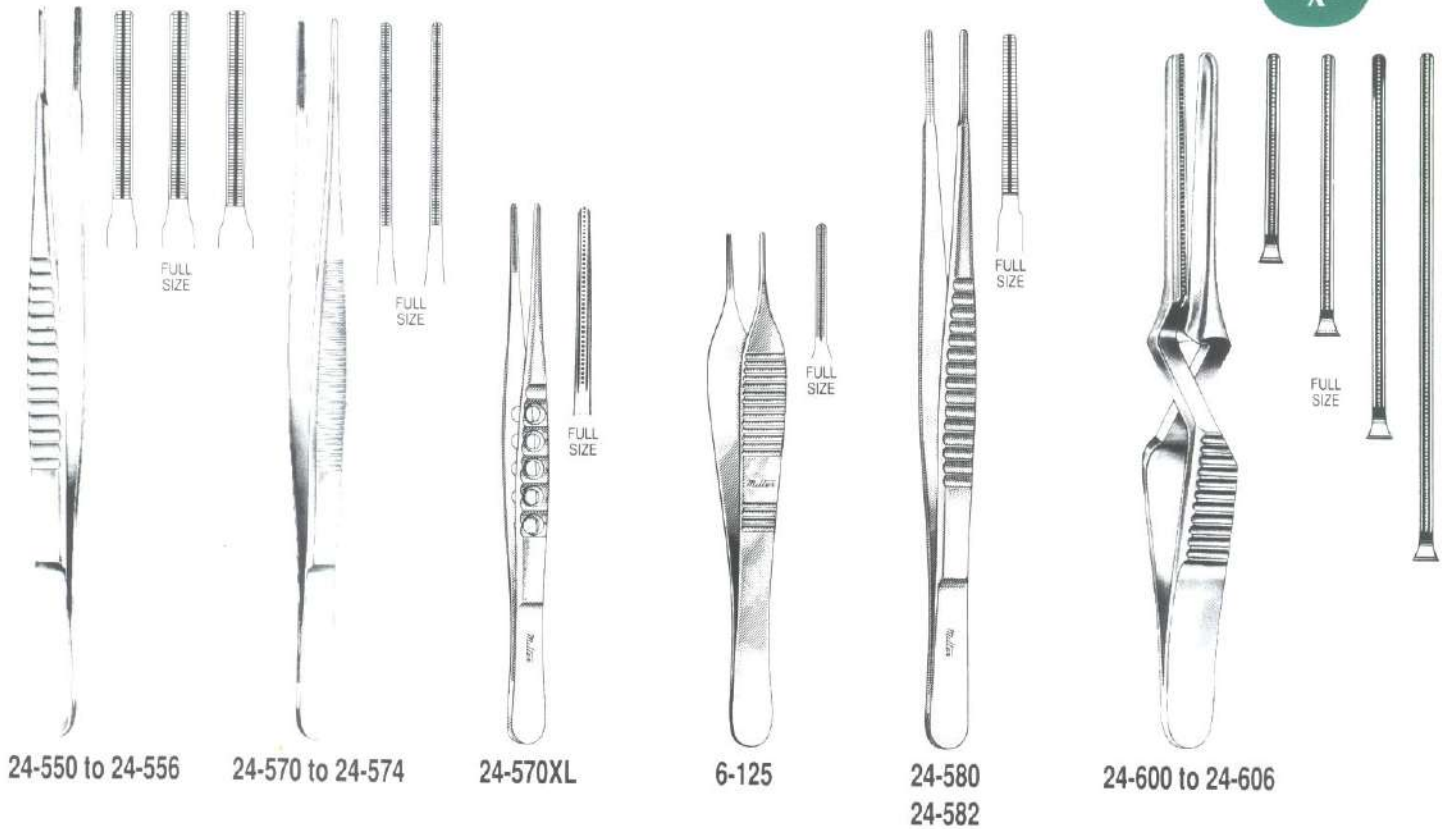

DeBAKEY THORACIC TISSUE FORCEPS, 2.5 mm wide tips

24-550	6" (15.2 cm)	24-554	9½" (24.1 cm)
24-552	7½" (19.7 cm)	24-556	12" (30.5 cm)

DeBAKEY VASCULAR TISSUE FORCEPS, 1.5 mm wide tips

24-570	6" (15.2 cm)
24-570XL	6" (15.2 cm), lightweight with fenestrated handles
24-572	8" (20.3 cm)
24-574	9½" (24.1 cm)
6-125	DeBAKEY-ADSON Tissue Forceps 4¾" (12.1 cm), 1.5 mm wide tips

24-580	COOLEY Vascular Tissue Forceps 6" (15.2 cm), tips 2 mm wide
24-582	COOLEY Vascular Tissue Forceps 8" (20.3 cm), tips 2 mm wide

DeBAKEY BULLDOG CLAMPS, Cross Action

Straight	Size	Tips	Curved
24-600	7.5 cm	2 cm	24-650
24-602	8.5 cm	3 cm	24-652
24-604	10.5 cm	4.5 cm	24-654
24-606	12 cm	6 cm	24-656

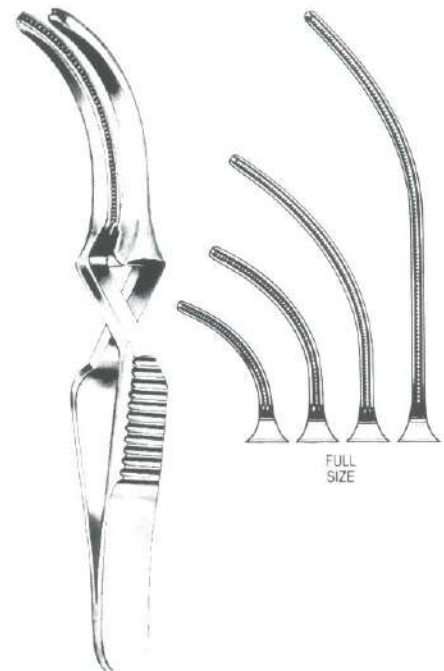

24-650 to 24-656

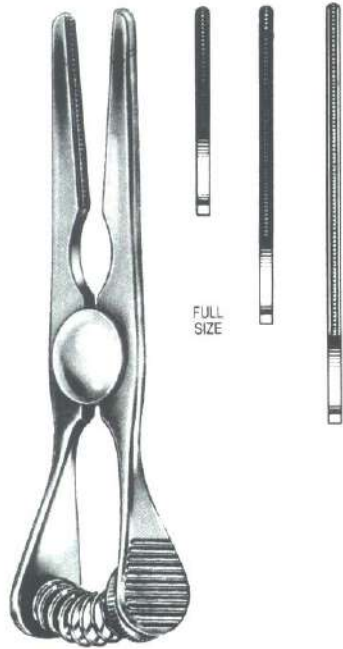

24-700 to 24-704

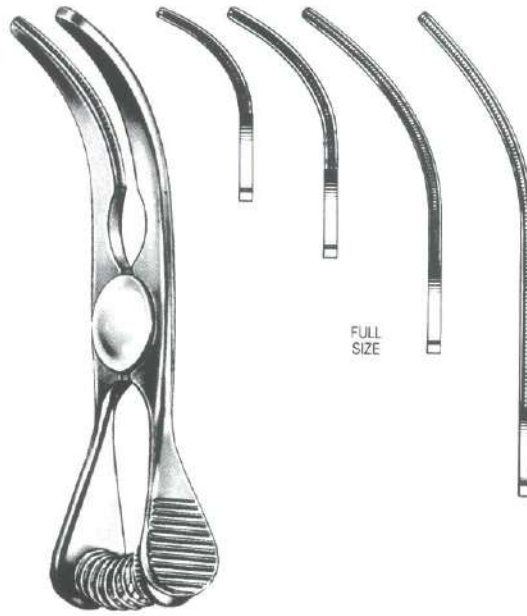

24-750 to 24-756

GLOVER BULLDOG CLAMPS, with Spring Tension Adjusting Screw

Straight	Size	Jaws	Curved
24-700	7 cm	2 cm	24-750
24-702	8 cm	2.5 cm	24-752
24-704	9 cm	4 cm	24-754
—	11 cm	6 cm	24-756

Atraumatic Forceps



24-800

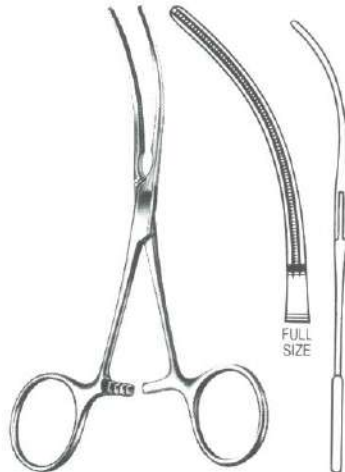

24-802



24-804

DeBAKEY RING HANDLED BULLDOG CLAMPS

- 24-800 Straight 5" (12.7 cm)
- 24-802 Curved 4¾" (12.1 cm)
- 24-804 90° Angle 4" (10.2 cm)
- 24-806 45° Angle 4⅞" (12.4 cm)
- 24-808 S-Curved 4¾" (12.1 cm)

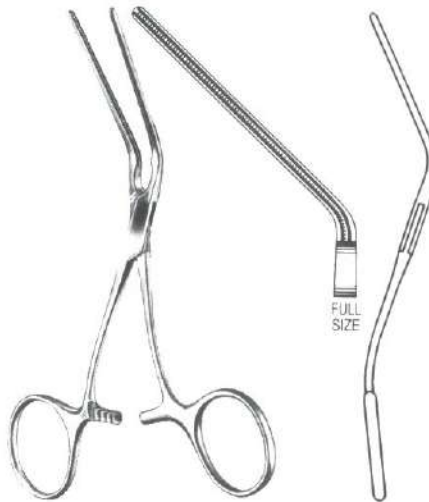

24-806

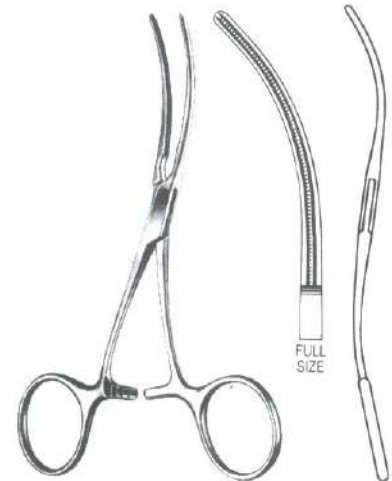

24-808



24-900



24-1000
24-1100

- 24-900 LEE Right Angle Bronchus and General Purpose Vascular Clamp 9" (22.9 cm)
- 24-1000 GLOVER Patent Ductus Clamp 8" (20.3 cm), straight, 3 cm jaws
- 24-1002 GLOVER Patent Ductus Clamp 8" (20.3 cm), angular, 3 cm jaws
- 24-1100 GLOVER Coarctation Clamp 8¾" (22.2 cm), straight, 6 cm jaws
- 24-1102 GLOVER Coarctation Clamp 8¾" (22.2 cm), angular, 6 cm jaws



24-1002
24-1102

Atraumatic Forceps



24-1150



24-1152

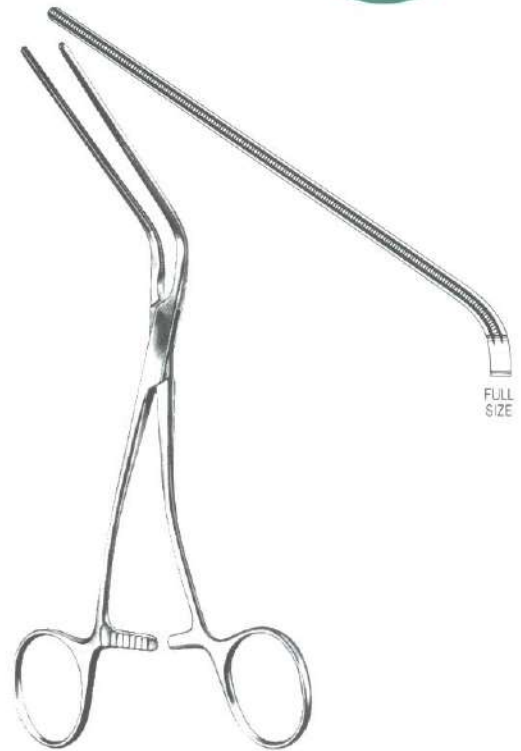

24-1180

- 24-1150 DeBAKEY Patent Ductus and Peripheral Vascular Clamp 8" (20.3 cm) straight, 3 cm jaws
- 24-1152 DeBAKEY Patent Ductus and Peripheral Vascular Clamp 8" (20.3 cm) angular, 3 cm jaws
- 24-1180 DeBAKEY Peripheral Vascular Clamp 7" (17.8 cm), angled jaws 6.5 cm
- 24-1190 DeBAKEY Peripheral Vascular Clamp 8" (20.3 cm), S-Shaped
- 24-1200 DeBAKEY Peripheral Vascular Clamp 6" (15.2 cm), curved jaws

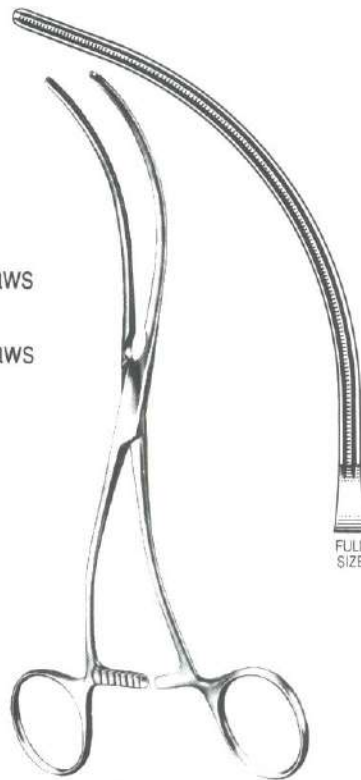

24-1190



24-1200



24-1250

24-1250 LAMBERT-KAY Vascular Clamp for Aortic Anastomosis 8" (20.3 cm), jaws 4.5 cm wide, 1.9 cm deep

24-1300 DeBAKEY-SEMB Ligature Carrier 10¼" (26 cm)

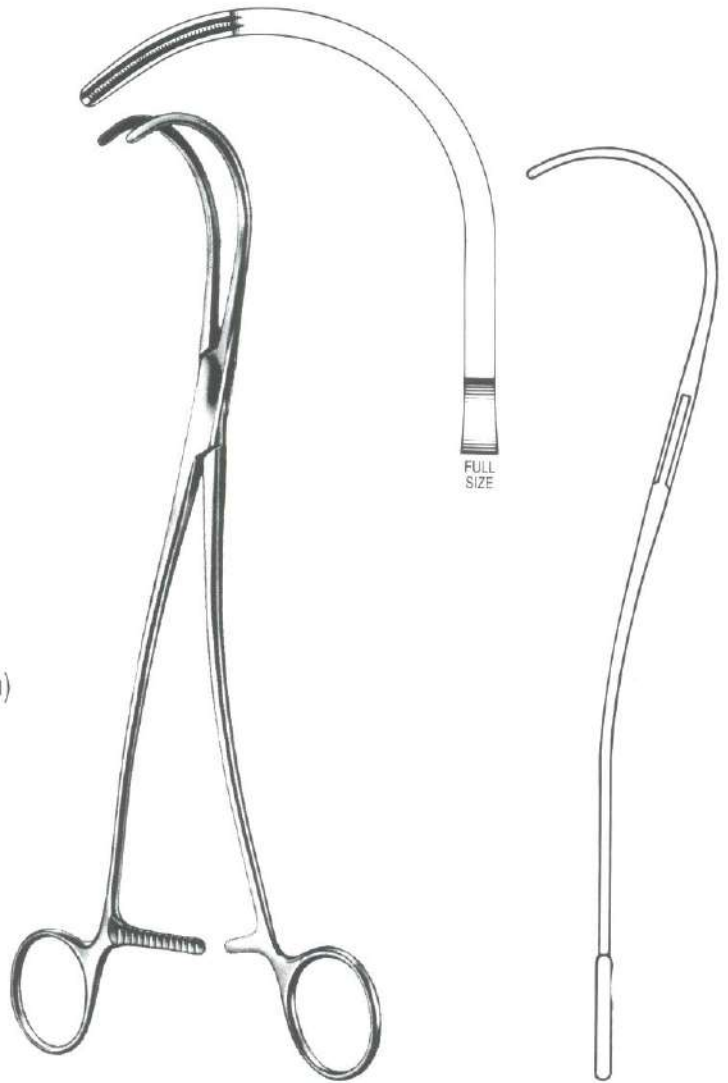

24-1300

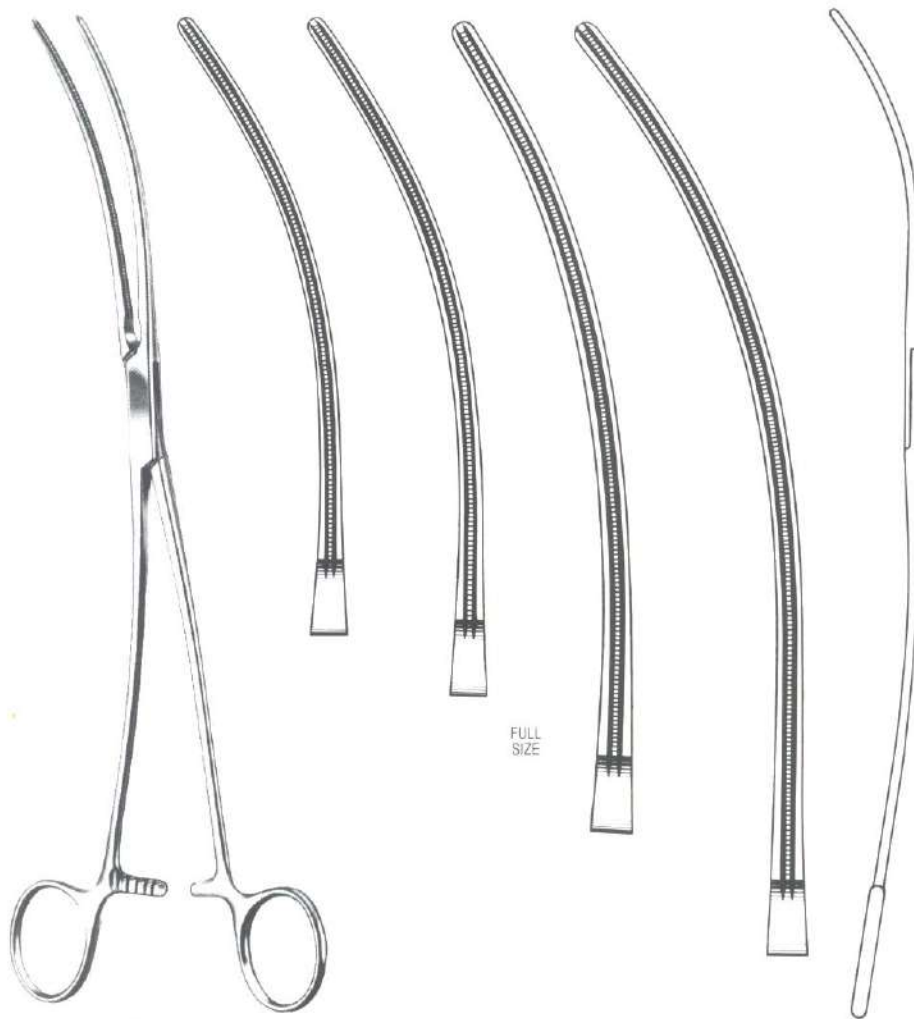

24-1400 to 24-1412

- 24-1400 DeBAKEY Vascular Clamp for Aortic Aneurism 10" (25.4 cm), slightly curved jaws 7.5 cm
- 24-1404 DeBAKEY Vascular Clamp for Aortic Aneurism 10½" (26.7 cm), slightly curved jaws 8.5 cm
- 24-1408 DeBAKEY Vascular Clamp for Aortic Aneurism 12¼" (31 cm), slightly curved jaws 10 cm
- 24-1412 DeBAKEY Vascular Clamp for Aortic Aneurism 12¾" (32.4 cm), slightly curved jaws 12 cm



24-1500

24-1500 DeBAKEY Vascular Clamp for Aortic Aneurism 9½" (24.1 cm), strongly curved jaws

DeBAKEY MULTIPURPOSE CLAMPS,
OBTUSE ANGLE, 60°

24-1600 9½" (24.1 cm) long, 4 cm jaws

24-1602 8¼" (21 cm) long, 5 cm jaws

24-1604 9½" (24.1 cm) long, 6.5 cm jaws

24-1606 12" (30.5 cm) long, 10 cm jaws



FULL
SIZE

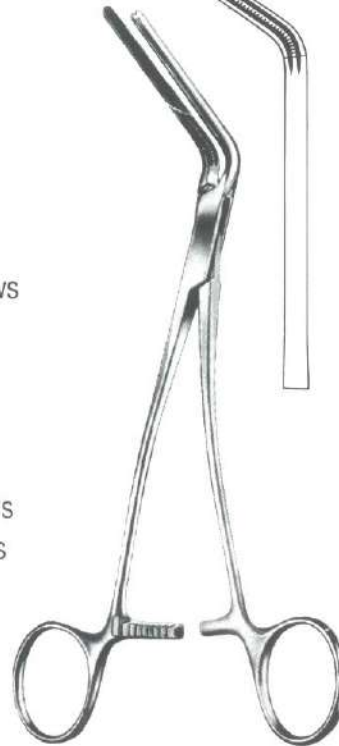

24-1600 to 24-1606



24-1650 to 24-1656



FULL
SIZE

DeBAKEY MULTIPURPOSE CLAMPS, RIGHT ANGLE, 90°

24-1650	9" (22.9 cm) long,	4 cm jaws
24-1654	8" (20.3 cm) long,	6.5 cm jaws
24-1656	10½" (26.7 cm) long,	10 cm jaws



24-2000 to 24-2040

- 24-2000 DeBAKEY Tangential Occlusion Clamp 8" (20.3 cm)
- 24-2010 DeBAKEY Tangential Occlusion Clamp 10" (25.4 cm)
- 24-2020 DeBAKEY Tangential Occlusion Clamp 10¼" (26 cm)
- 24-2030 DeBAKEY Tangential Occlusion Clamp 10½" (26.7 cm)
- 24-2040 DeBAKEY Tangential Occlusion Clamp 11" (27.9 cm)

- 24-2050 WYLIE "J" Clamp 9" (22.9 cm), 3.3 cm wide x 2.5 cm deep jaws



24-2050

Atraumatic Forceps

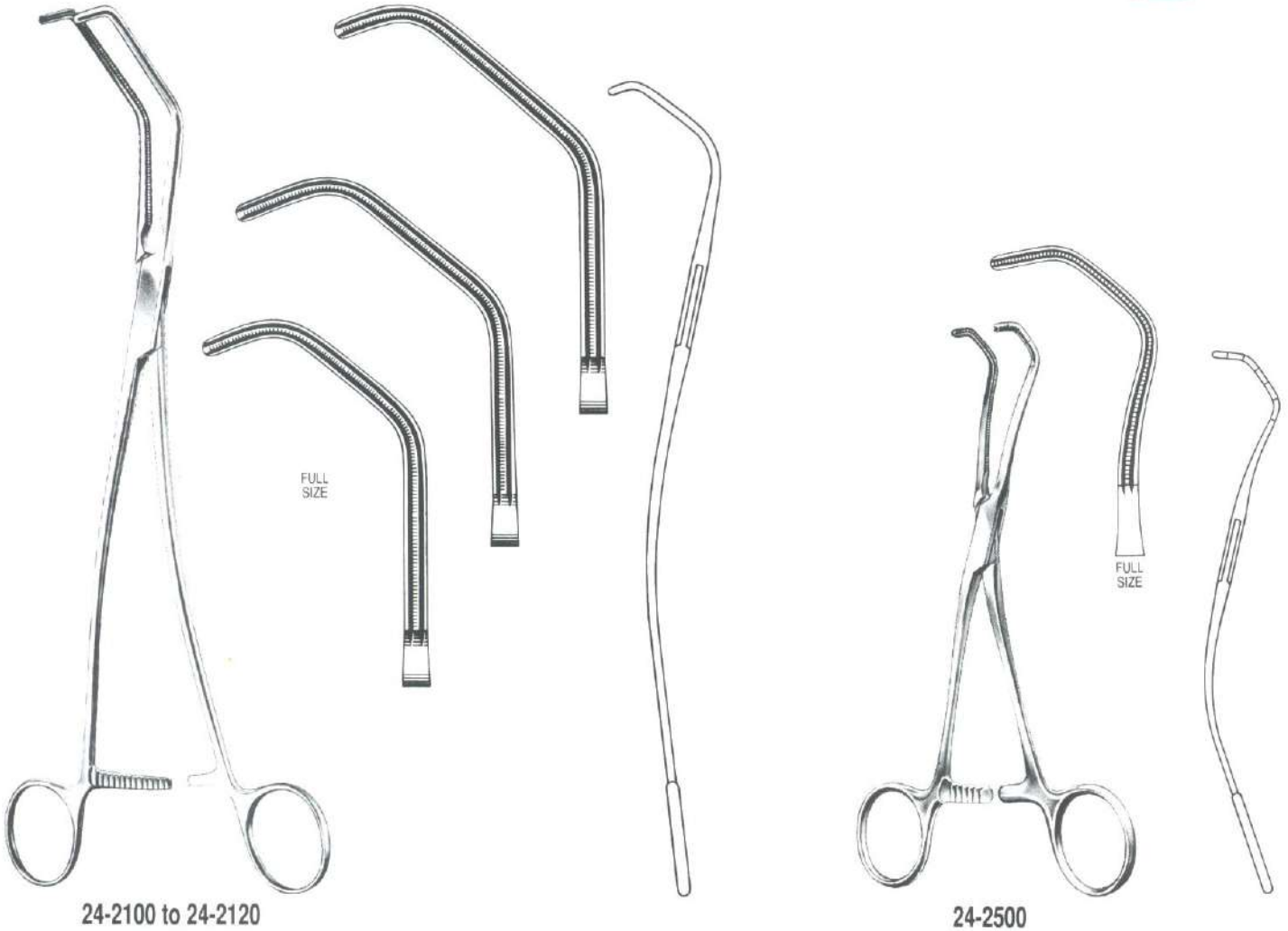

24-2100 to 24-2120

24-2500

- 24-2100 SATINSKY-DeBAKEY Vascular Clamp for Vena Cava 9 $\frac{3}{4}$ " (24.8 cm), small
- 24-2110 SATINSKY-DeBAKEY Vascular Clamp for Vena Cava 9 $\frac{3}{4}$ " (24.8 cm), medium
- 24-2120 SATINSKY-DeBAKEY Vascular Clamp for Vena Cava 9 $\frac{3}{4}$ " (24.8 cm), large
- 24-2500 COOLEY Pediatric Vascular Clamp for Anastomosis 6 $\frac{1}{2}$ " (16.5 cm), with 5mm graduations on jaws

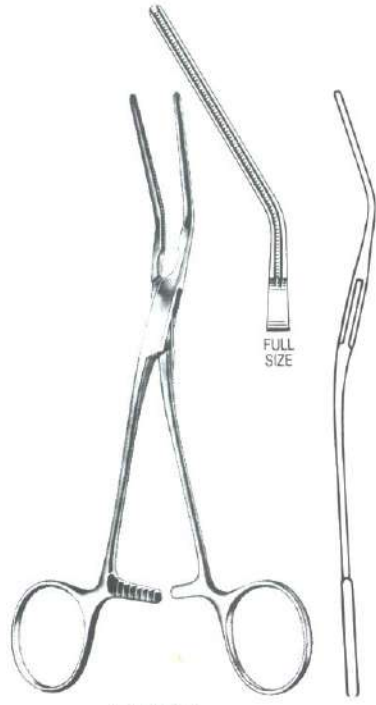

24-2700

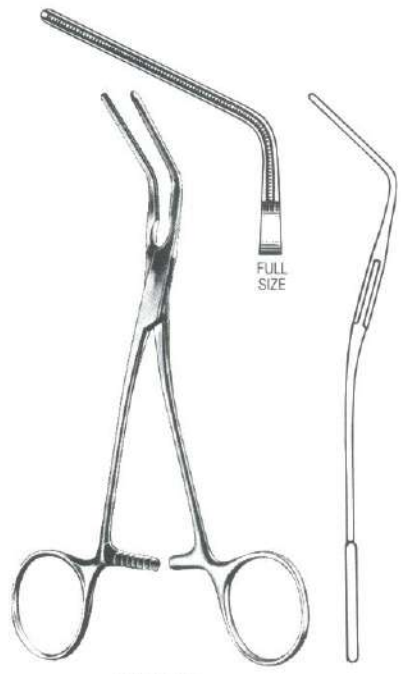

24-2710



24-2720

- 24-2700 DeBAKEY Pediatric Multi-Purpose Clamp 6½" (16.5 cm), angled 30°
- 24-2710 DeBAKEY Pediatric Multi-Purpose Clamp 6" (15.2 cm), angled 60°
- 24-2720 DeBAKEY Pediatric Multi-Purpose Clamp 5½" (14 cm), angled 90°
- 24-2960 DeBAKEY-DERRA Vascular Clamp for Anastomosis 6¼" (15.9 cm), small jaws
- 24-2961 DeBAKEY-DERRA Vascular Clamp for Anastomosis 6¾" (17.1 cm), medium jaws
- 24-2962 DeBAKEY-DERRA Vascular Clamp for Anastomosis 7" (17.8 cm), large jaws



24-2960 to 24-2962

Atraumatic Forceps

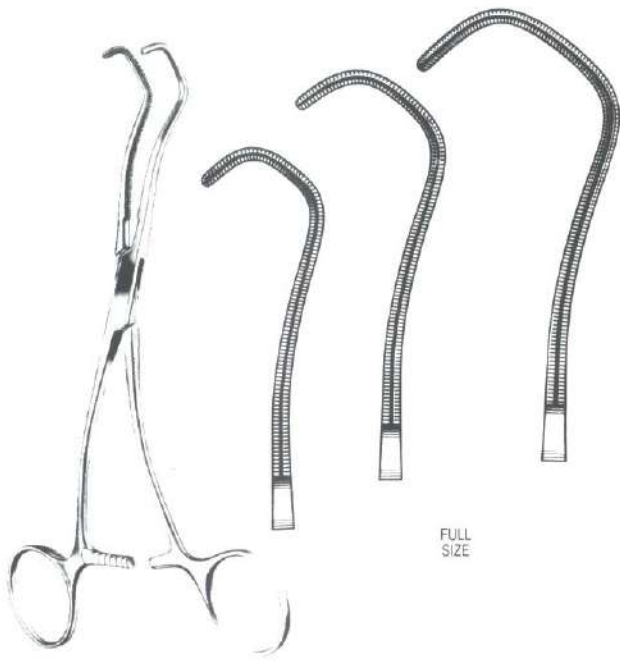

24-3000 to 24-3020



24-3200

COOLEY-DERRA Pediatric Vascular Clamps for Anastomosis 6½" (16.5 cm)

- 24-3000 small
- 24-3010 medium
- 24-3020 large

COOLEY Pediatric Vascular Clamps 5½" (14 cm)
5 mm calibrations on outer sides of jaws

- 24-3200 angled jaws 25 mm, straight handles
- 24-3210 straight jaws 25 mm, angled handles
- 24-3220 straight jaws 25 mm, straight handles

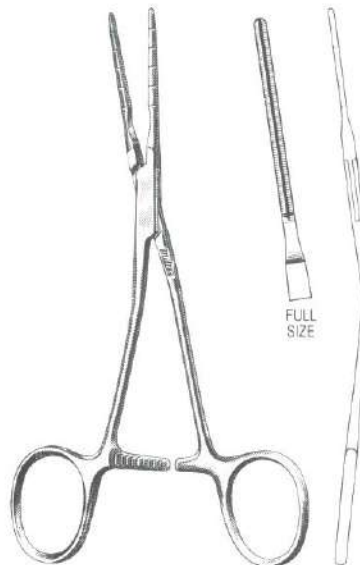

24-3210



24-3220



24-3230 to 24-3250

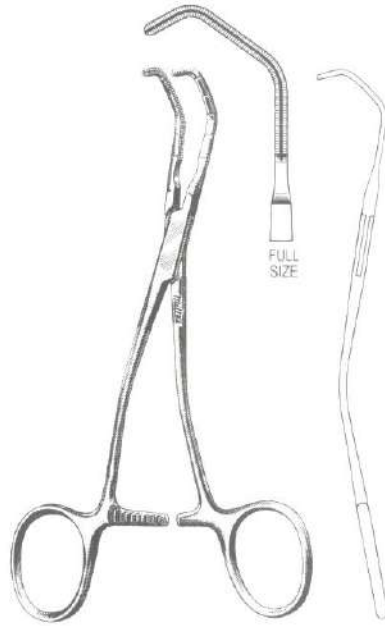

24-3260

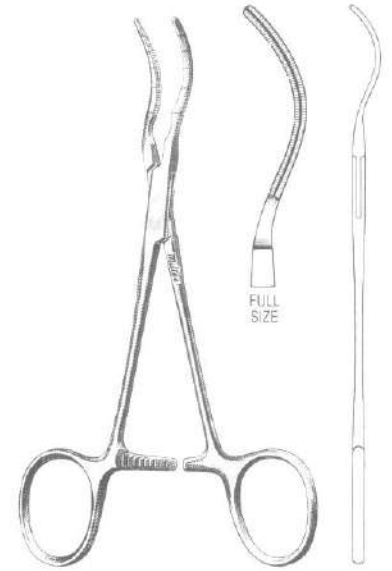

24-3270

COOLEY CLAMPS Pediatric Vascular Clamps,
5 mm calibrations on outer sides of jaws 4³/₄" (12.1 cm)

24-3230 right angle jaws 17 mm, straight handles

24-3240 right angle jaws 25 mm, straight handles

24-3250 right angle jaws 35 mm, straight handles

24-3260 COOLEY-SATINSKY Clamp 5¹/₂" (14 cm)

24-3270 COOLEY Spoon Shape Clamp 5¹/₂" (14 cm)

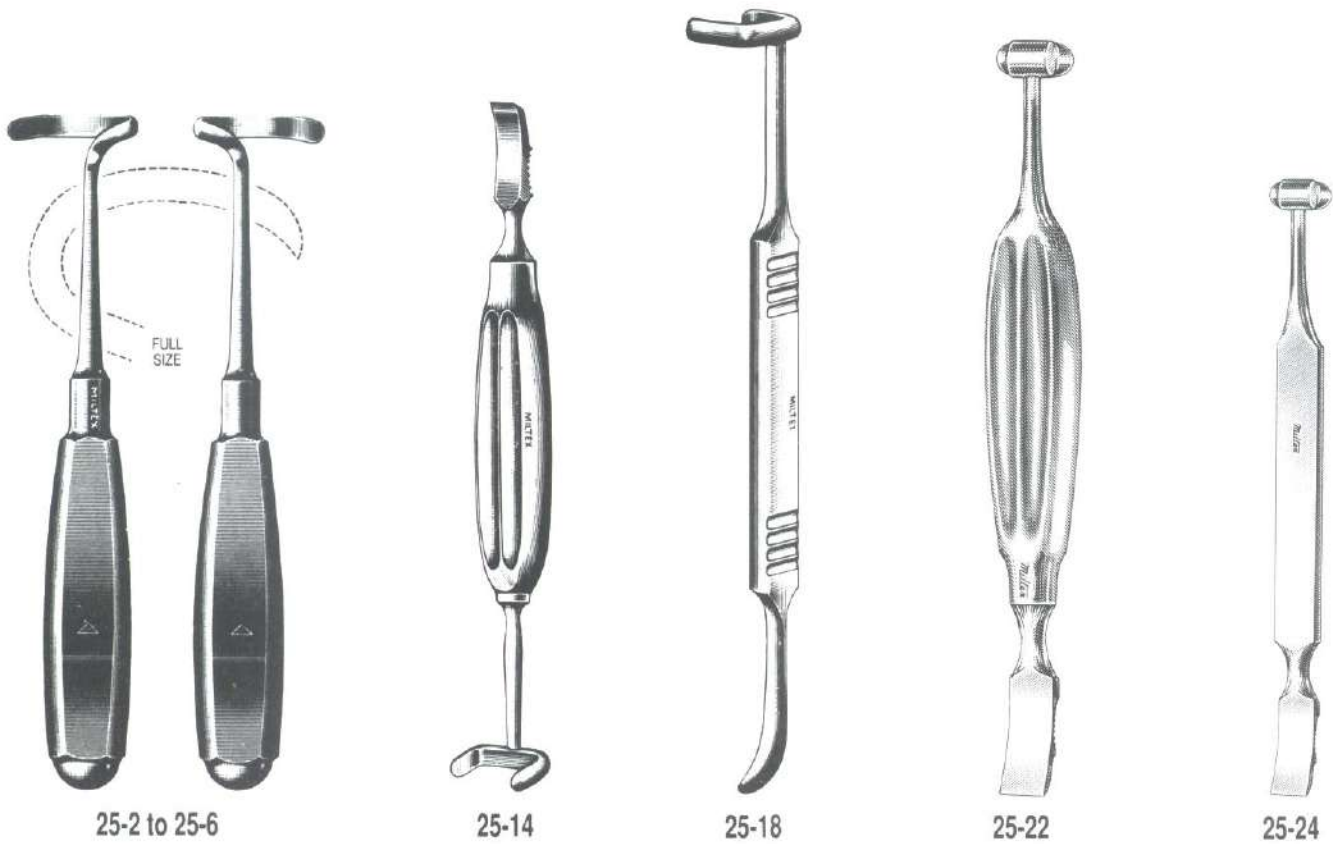

DOYEN RIB ELEVATORS AND RASPATORIES 7" (17.8 cm)

- 25-2 Adult Size, right
- 25-4 Adult Size, left
- 25-6 Child Size, right
- 25-14 MATSON-ALEXANDER Rib Elevator and Stripper 8¾" (22.2 cm)
- 25-18 MATSON Rib Elevator and Stripper 8¾" (22.2 cm)
- 25-22 ALEXANDER-FARABEU F Periosteotome 8¼" (21 cm), standard size, 12 mm and 24 mm wide ends
- 25-24 ALEXANDER-FARABEU F Periosteotome 6" (15.2 cm), pediatric size, 10 mm and 14 mm wide ends



25-28

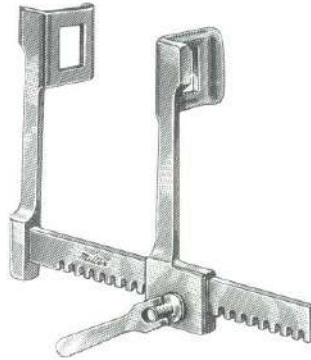

25-98

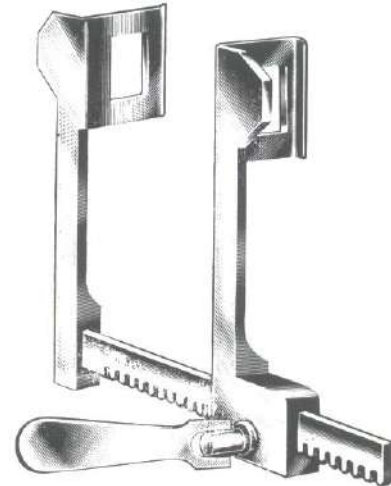

25-100 to 25-106

- 25-28** SEDILLOT Periosteal Elevator 7½" (19.1 cm), blade 17 mm wide
- 25-98** FINOCHIETTO-DeBAKEY Infant Rib Spreader, blades 19 mm deep x 21 mm wide, 85 mm spread, light construction
- FINOCHIETTO RIB SPREADERS, Original Model
- 25-100** Child Size, blades 38 mm deep x 45 mm wide, 6" (15.2 cm) spread, straight arms
- 25-102** Standard Size, blades 48 mm deep x 65 mm wide, 8" (20.3 cm) spread, straight arms
- 25-104** Standard Size, blades 48 mm deep x 65 mm wide, 10" (25.4 cm) spread, straight arms
- 25-106** Standard Size, blades 48 mm deep x 65 mm wide, 12" (30.5 cm) spread, straight arms
- 25-130** Standard Size, blades 48 mm deep x 65 mm wide, 8" (20.3 cm) spread, curved arms
- 25-132** Standard Size, blades 48 mm deep x 65 mm wide, 10" (25.4 cm) spread, curved arms
- 25-134** Standard Size, blades 48 mm deep x 65 mm wide, 12" (30.5 cm) spread, curved arms

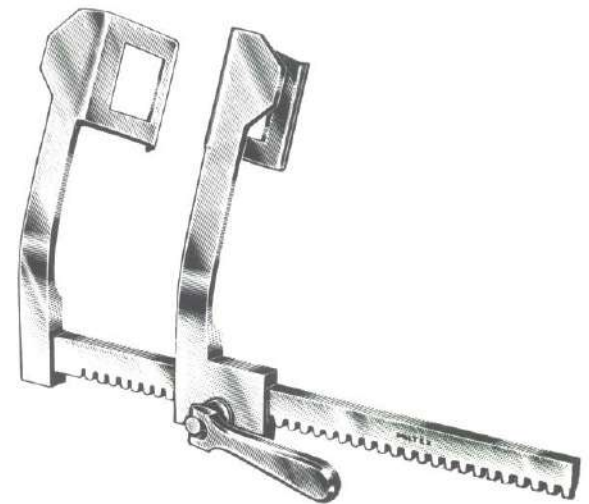

25-130 to 25-134

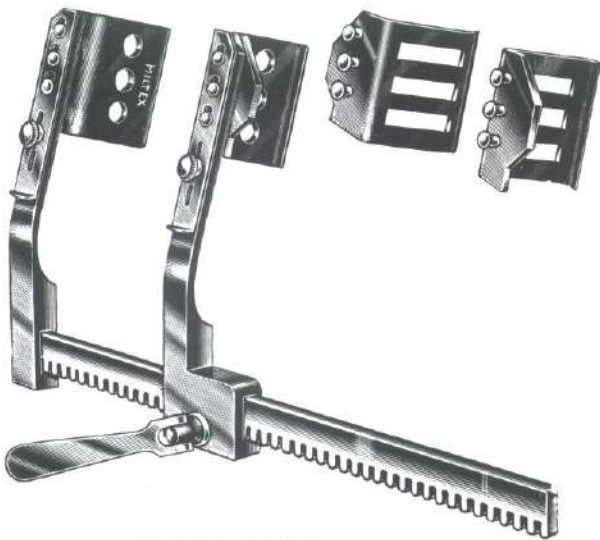

25-140 to 25-144



25-150 to 25-154

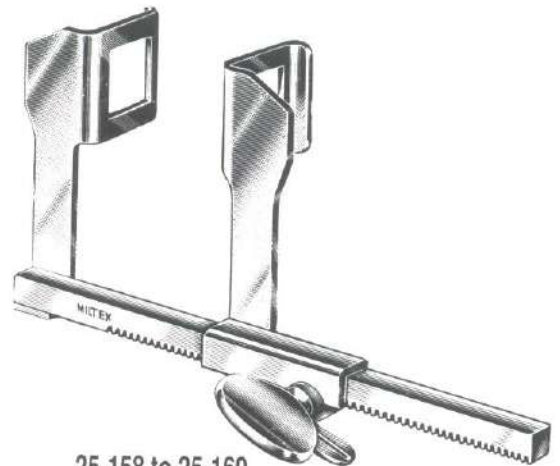

25-158 to 25-160

BURFORD-FINOCHIETTO RIB SPREADERS
with 2 pairs interchangeable blades 48 mm deep x 65 mm wide,
and 72 mm deep x 65 mm wide

25-140	8" (20.3 cm) Spread	25-142	10" (25.4 cm) Spread	25-144	12" (30.5 cm) Spread
---------------	---------------------	---------------	----------------------	---------------	----------------------

BURFORD-FINOCHIETTO RIB SPREADERS, LIGHT WEIGHT ALUMINUM
with 2 pairs interchangeable blades 43 mm deep x 63 mm wide,
and 65 mm deep x 63 mm wide

25-150	8" (20.3 cm) Spread	25-152	10" (25.4 cm) Spread	25-154	12" (30.5 cm) Spread
---------------	---------------------	---------------	----------------------	---------------	----------------------

25-158 HAIGHT Baby Rib Spreader, 6.5 cm arms, 32 x 32 mm blades, 11 cm spread

25-160 HAIGHT Baby Rib Spreader, 9 cm arms, 32 x 32 mm blades, 11 cm spread

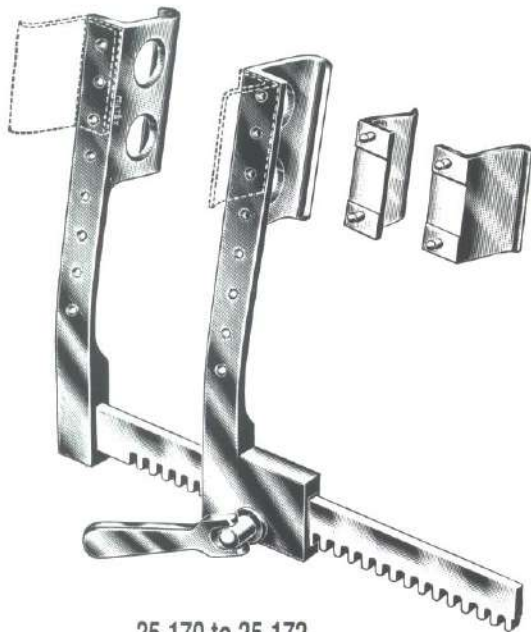

25-170 to 25-172



11-672



11-676

HARKEN RIB SPREADERS and SCAPULA RETRACTORS,
blades 45 mm deep x 65 mm wide,
with detachable scapula blades 43 mm deep x 50 mm wide

- | | | | |
|---------------|---|---------------|----------------------|
| 25-170 | 8" (20.3 cm) Spread | 25-172 | 10" (25.4 cm) Spread |
| 11-672 | BADGLEY Rib Spreader, 4 x 4 blunt teeth, 2" (5.1 cm) x 1 3/4" (4.4 cm), 6 1/2" (16.5 cm) spread | | |
| 11-676 | TUFFIER Rib Spreader, 2" (5.1 cm) x 1 3/4" (4.4 cm), grooved blades, 6 1/2" (16.5 cm) spread | | |

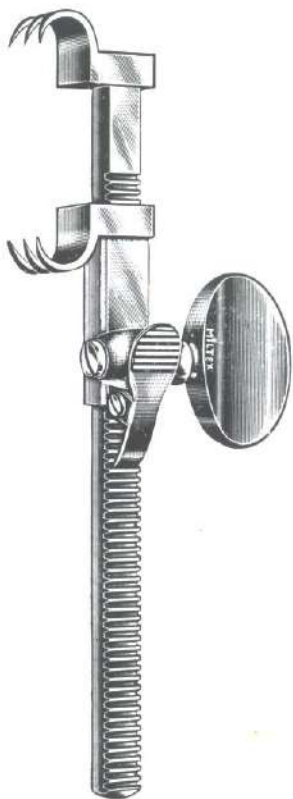

25-200

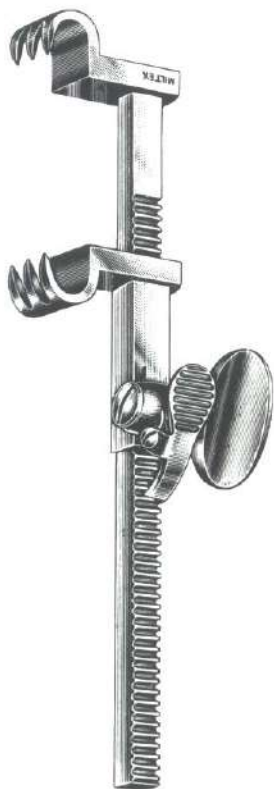

25-202

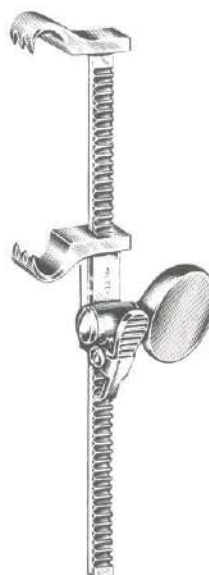

25-204



11-314 to 11-318

- 25-200 BAILEY Rib Contractor, Standard model
- 25-202 BAILEY-GIBBON Rib Contractor, with 9 mm longer arms than standard model
- 25-204 BAILEY Pediatric Rib Contractor, light-weight construction
- 11-314 HARRINGTON Splanchnik Retractor 12" (30.5 cm), large blade 2½" (6.4 cm) wide
- 11-316 HARRINGTON Splanchnik Retractor 12" (30.5 cm), small blade 1½" (3.8 cm) wide
- 11-318 HARRINGTON Splanchnik Retractor 9½" (24.1 cm), extra small blade 1" (2.5 cm) wide

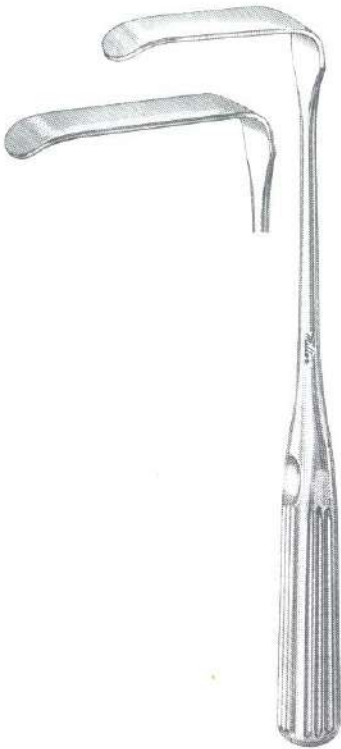

25-272
25-274



11-246 to 11-249

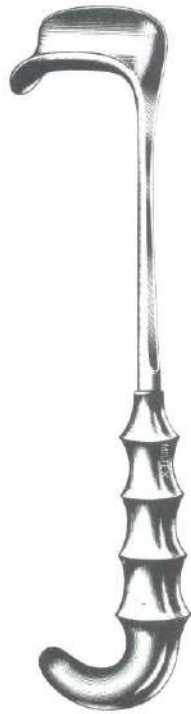

11-250 to 11-256

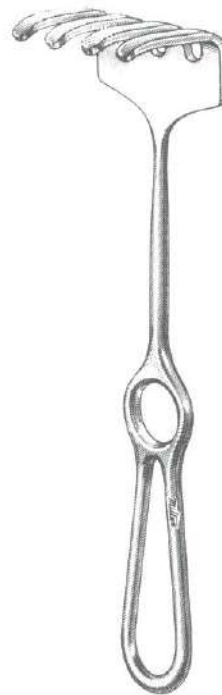

11-349



11-350
11-352

- 25-272** SAUERBRUCH Retractor 9" (22.9 cm), Size 2, blade $\frac{7}{8}$ " (2.2 cm) x $2\frac{1}{4}$ " (5.7 cm)
25-274 SAUERBRUCH Retractor 9" (22.9 cm), Size 3, blade $\frac{3}{4}$ " (1.9 cm) x $2\frac{7}{8}$ " (7.3 cm)

RICHARDSON RETRACTORS 9 $\frac{1}{2}$ " (24.1 cm)

With Loop Handle	Blade Size	With Hollow Grip Handle
11-246	1" (2.5 cm) x $\frac{3}{4}$ " (1.9 cm)	11-250
11-247	$1\frac{1}{4}$ " (3.2 cm) x 1" (2.5 cm)	11-252
11-248	$1\frac{1}{2}$ " (3.8 cm) x $1\frac{1}{2}$ " (3.8 cm)	11-254
11-249	2" (5.1 cm) x $\frac{3}{4}$ " (1.9 cm)	11-256
11-349	OLLIER Retractor 8 $\frac{1}{2}$ " (21.6 cm), blunt, 4 prongs $2\frac{1}{4}$ " (5.7 cm) x $1\frac{3}{4}$ " (4.4 cm)	
11-350	ISRAEL Retractor 9" (22.9 cm), blunt, 4 prongs $1\frac{1}{2}$ " (3.8 cm) x $1\frac{5}{8}$ " (4.1 cm)	
11-352	ISRAEL Retractor 9" (22.9 cm), blunt, 6 prongs $2\frac{1}{4}$ " (5.7 cm) x $1\frac{3}{4}$ " (4.4 cm)	
11-590	HIBBS Retractor 9 $\frac{1}{4}$ " (23.5 cm), blade 1" (2.5 cm) x 3" (9.6 cm) deep	



11-590

For additional Retractors see pages 151 - 187



25-302



25-306

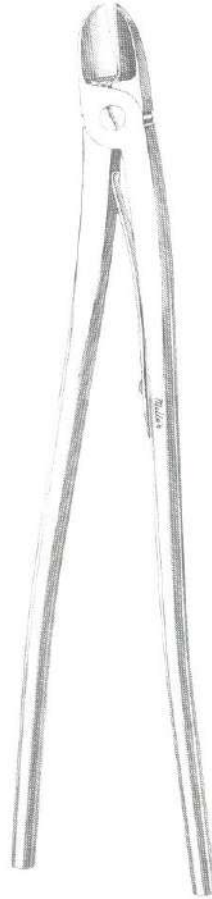

25-350

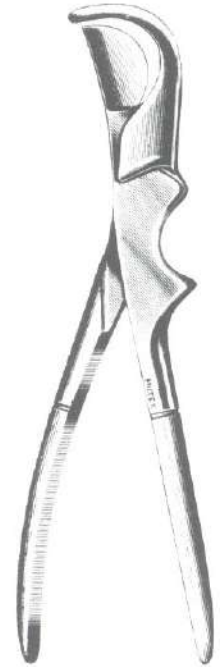

25-360

- 25-302 ALLISON Lung Retractor 12³/₄" (32.4 cm), standard size 2" (5.1 cm) wide blade
- 25-306 DAVIDSON Scapula Retractor, blade 3¹/₂" (8.9 cm) wide x 3¹/₄" (8.3 cm) deep
- 25-350 BETHUNE Rib Shears 13³/₄" (34.9 cm), double curved handles
- 25-360 GLUCK Rib Shears 8¹/₂" (21.6 cm)
- 25-362 STILLE Pattern Rib Shears 8¹/₂" (21.6 cm)

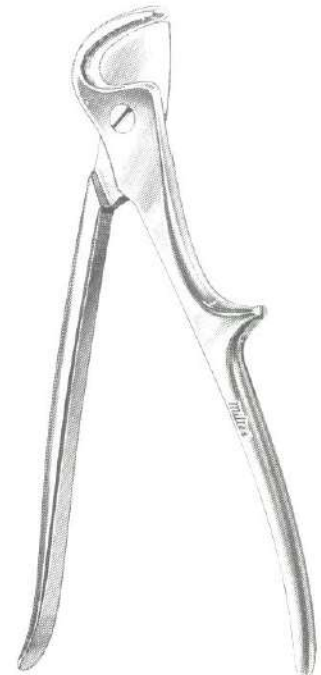

25-362



25-378

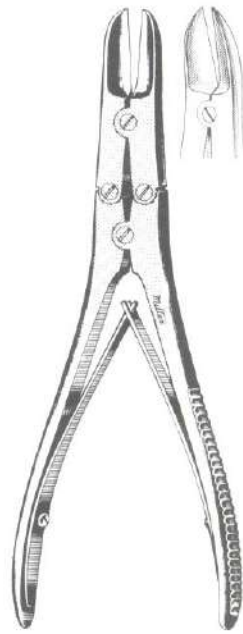

25-384 to 25-385

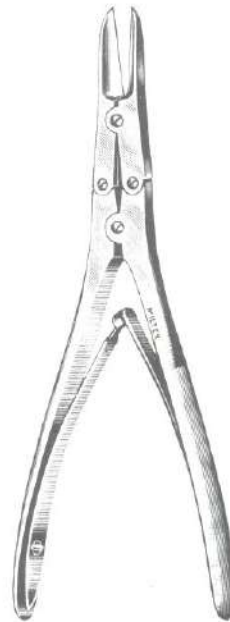

21-628

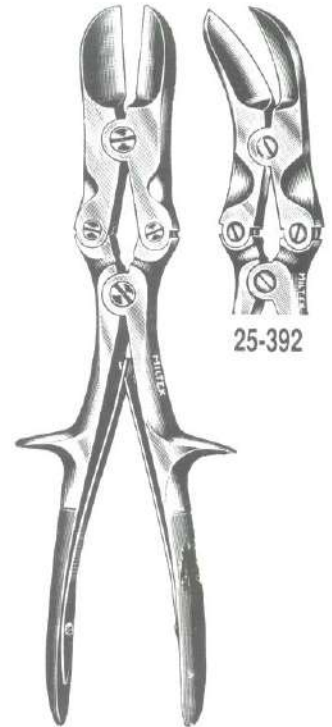

25-390

25-392

- 25-378 STILLE-GIERTZ Rib Shears 10" (25.4 cm)
- 25-384 RUSKIN Bone Cutting Forceps 7½" (19.1 cm), straight standard blades
- 25-385 RUSKIN Bone Cutting Forceps 7½" (19.1 cm), slightly angled standard blades
- 21-628 RUSKIN Bone Cutting Forceps 7½" (19.1 cm), straight delicate blades
- 25-390 STILLE-LISTON Bone Cutting Forceps 10¾" (27.3 cm), straight
- 25-392 STILLE-LISTON Bone Cutting Forceps 10¾" (27.3 cm), curved
- 25-396 STILLE-HORSLEY Bone Cutting Forceps 10½" (26.7 cm), angled blades



25-396



25-440

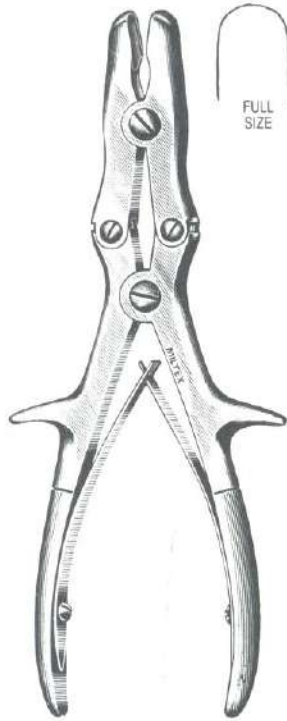

25-454

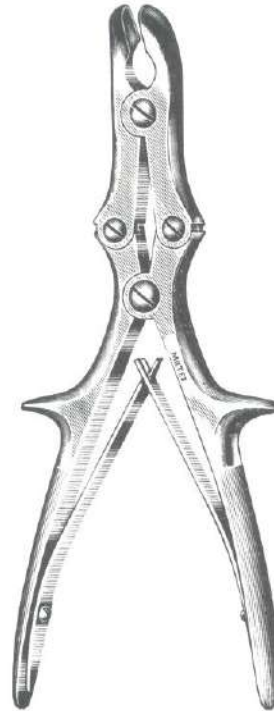

25-456

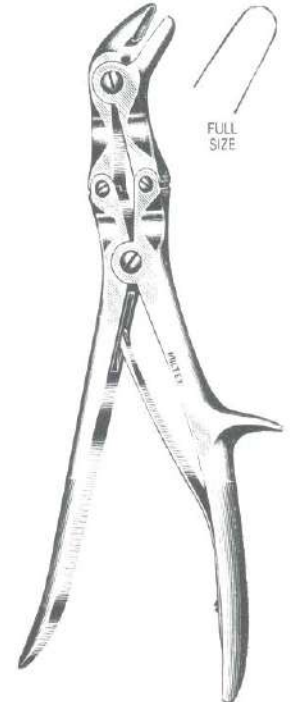

25-458

- 25-440 LEBSCHKE Sternum Knife 10" (25.4 cm)
- 25-454 STILLE-LUER Rongeur, 8 $\frac{3}{4}$ " (22.2 cm), straight jaws 9 x 15 mm
- 25-456 STILLE-LUER Rongeur, 8 $\frac{3}{4}$ " (22.2 cm), curved jaws 9 x 15 mm
- 25-458 STILLE-LUER Duckbill Rongeur, 9" (22.9 cm), angled on side jaws 6 x 12 mm

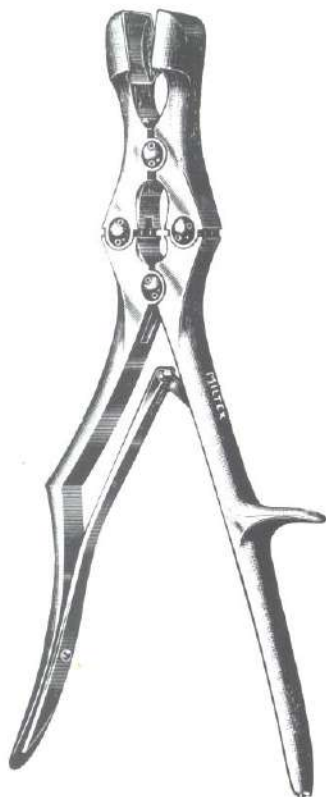

25-480

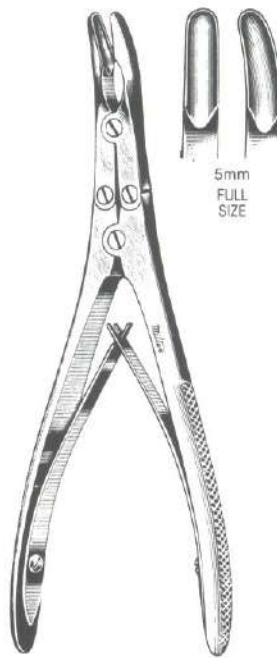

19-850 to 19-856

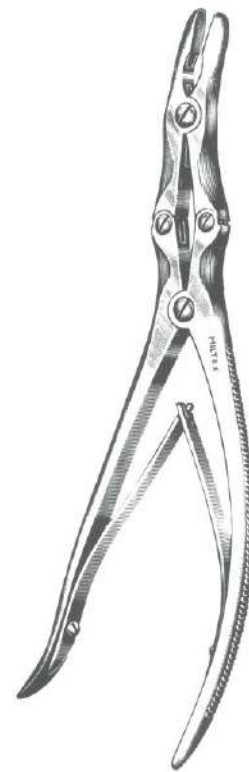

25-510
25-511

- 25-480 SAUERBRUCH Rongeur 12" (30.5 cm), straight, square jaws 17 mm wide
- 19-850 RUSKIN Rongeur 7¼" (18.4 cm), straight, 5 mm bite
- 19-852 RUSKIN Rongeur 7¼" (18.4 cm), curved, 5 mm bite
- 19-854 RUSKIN Rongeur 7¼" (18.4 cm), straight, 7 mm bite
- 19-856 RUSKIN Rongeur 7¼" (18.4 cm), curved, 7 mm bite
- 25-510 LEKSELL Rongeur 9½" (24.1 cm), standard curve, 3 mm bite
- 25-511 LEKSELL Rongeur 9½" (24.1 cm), standard curve, 8 mm bite

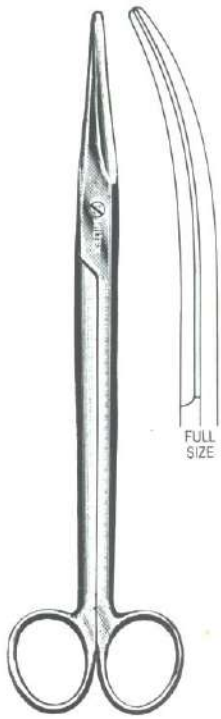

5-128
5-130



5-186 to 5-196



5-200



5-202

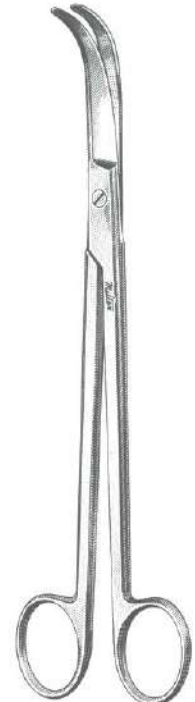

5-243

- 5-128 MAYO-HARRINGTON Dissecting Scissors 9" (22.9 cm), straight
- 5-130 MAYO-HARRINGTON Dissecting Scissors 9" (22.9 cm), curved

NELSON LOBECTOMY SCISSORS

Straight	Length	Curved
5-186	9" (22.9 cm)	5-188
5-190	11" (27.9 cm)	5-192
5-194	14½" (36.8 cm)	5-196

- 5-200 HARRINGTON (WILLAUER) Lobectomy Scissors 11½" (29.2 cm), straight

- 5-202 HARRINGTON (WILLAUER) Lobectomy Scissors 11½" (29.2 cm), curved

- 5-243 JORGENSON Scissors 9" (22.9 cm), strongly curved blades

- 5-244 THOREK Scissors 7¼" (18.4 cm), full curve
- 5-245 THOREK Scissors 10" (25.4 cm), full curve

- 5-260 SWEET Esophageal Scissors 8½" (21.6 cm), angled on flat

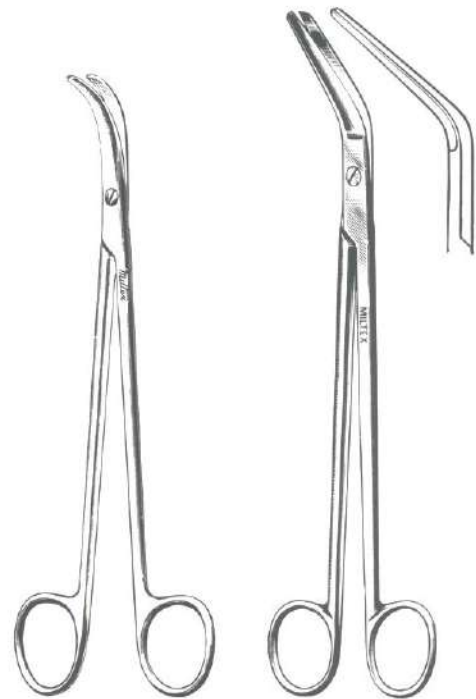

5-244
5-245

5-260

For Carb-N-Sert Scissors with tungsten carbide inserts see pages 55 - 59

For SuperCut Scissors see pages 60 - 63

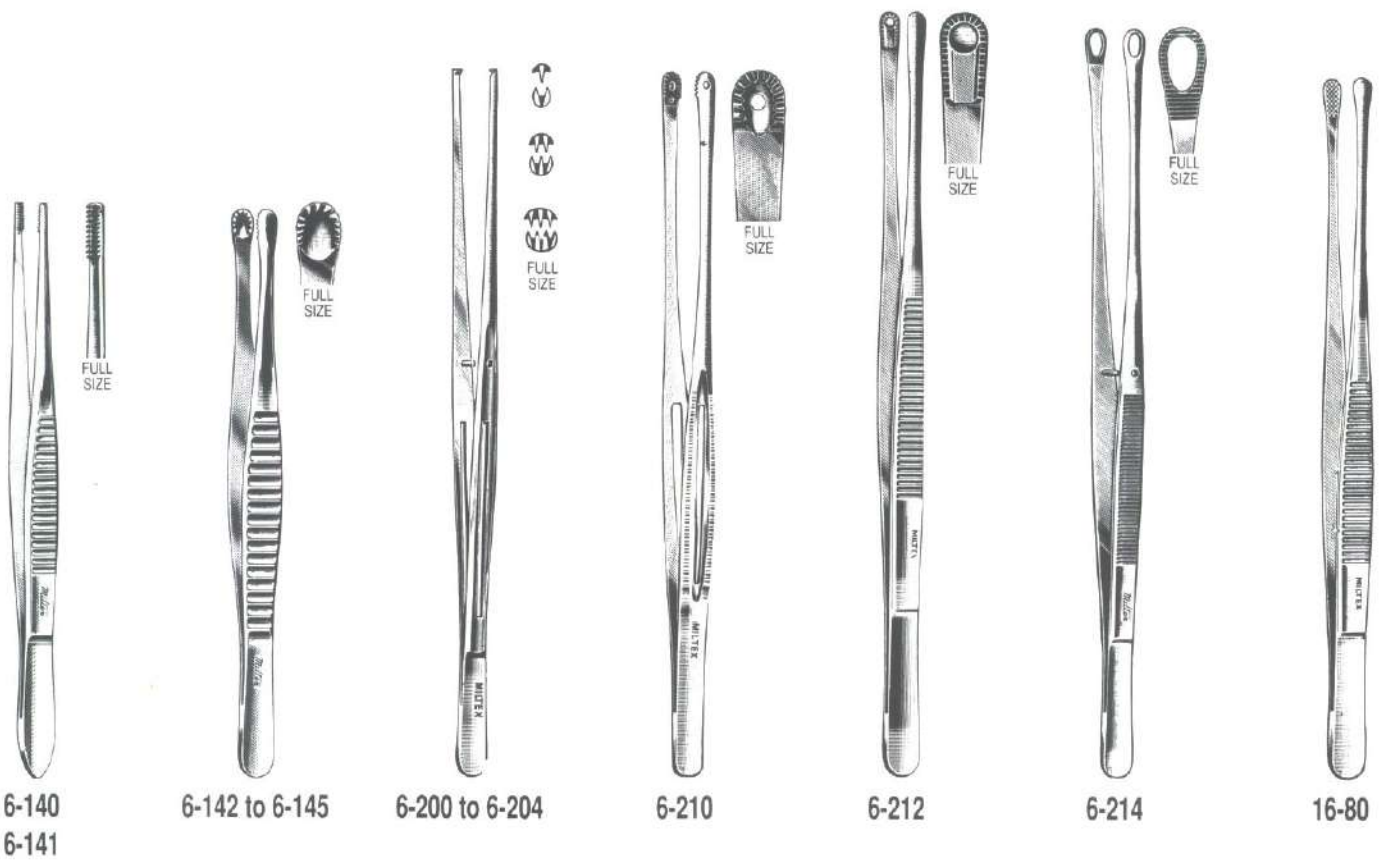

- 6-140 BROWN Side Grasping Tissue Forceps 8" (20.3 cm), 8 x 8 teeth
- 6-141 BROWN Side Grasping Tissue Forceps 10" (25.4 cm), 8 x 8 teeth
- 6-142 RUSSIAN Tissue Forceps 6" (15.2 cm)
- 6-144 RUSSIAN Tissue Forceps 8" (20.3 cm)
- 6-145 RUSSIAN Tissue Forceps 10" (25.4 cm)
- 6-200 KELLY Tissue Forceps 9" (22.9 cm), 1 x 2 teeth, slotted Gutch handle
- 6-202 KELLY Tissue Forceps 9" (22.9 cm), 2 x 3 teeth, slotted Gutch handle
- 6-204 KELLY Tissue Forceps 9" (22.9 cm), 3 x 4 teeth, slotted Gutch handle
- 6-210 MAYO-RUSSIAN Tissue Forceps 9" (22.9 cm), fenestrated jaws, slotted grooved handles
- 6-212 DAVIS Tissue Forceps 10" (25.4 cm), Russian type jaws
- 6-214 SINGLEY (TUTTLE) Tissue Forceps 9" (22.9 cm), fenestrated serrated jaws
- 16-80 WANGENSTEEN Tissue Forceps 9" (22.9 cm), rounded jaws with fine cross serrations

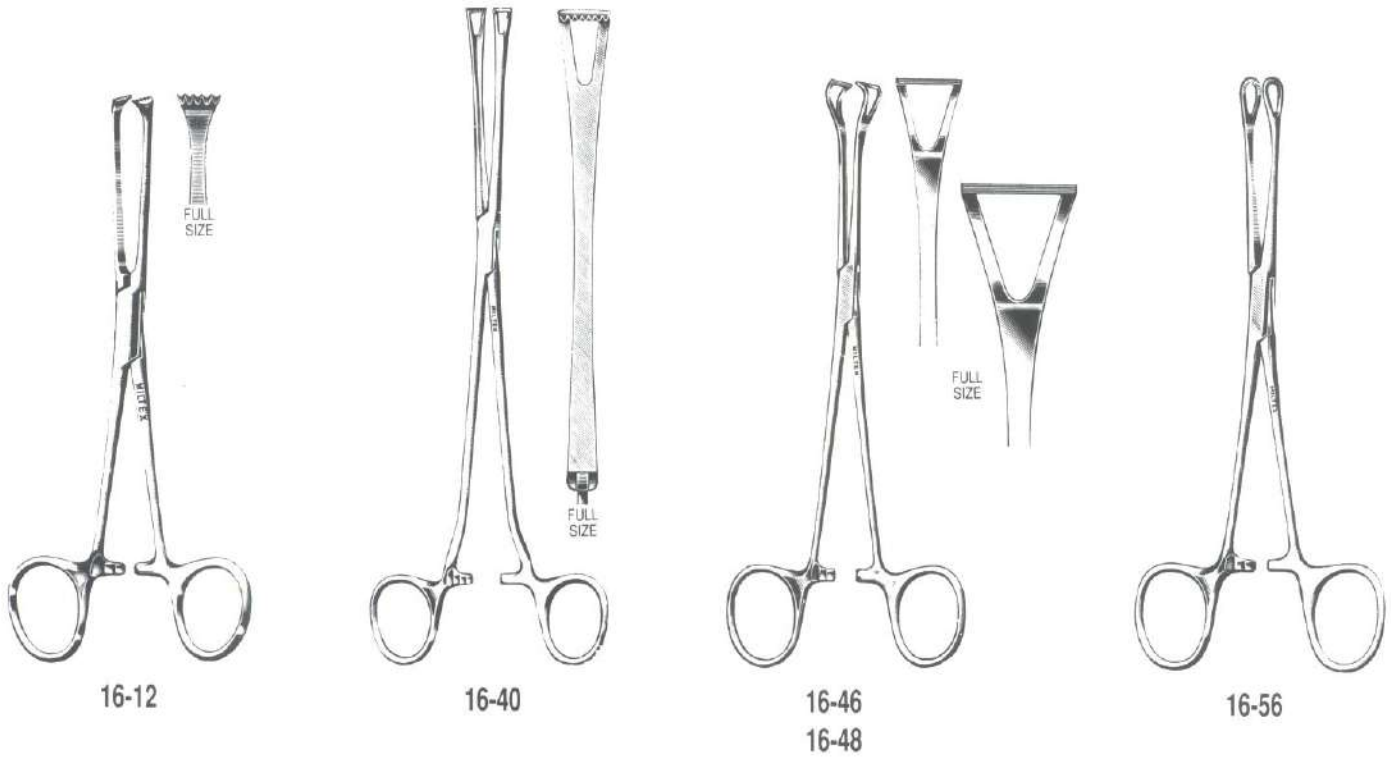

- 16-12 ALLIS Tissue Forceps 10" (25.4 cm), 5 x 6 teeth
- 16-40 LOCKWOOD Tissue Forceps 7¾" (19.7 cm)
- 16-46 BABCOCK Tissue Forceps 8¼" (21 cm)
- 16-48 BABCOCK Tissue Forceps 9½" (24.1 cm)
- 16-56 WILLIAMS Tissue Forceps 6½" (16.5 cm), fenestrated jaws with cross serrated tips

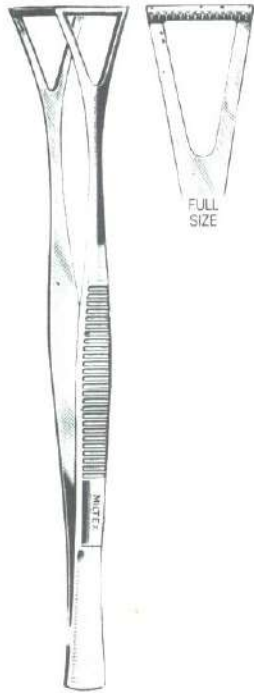

16-72

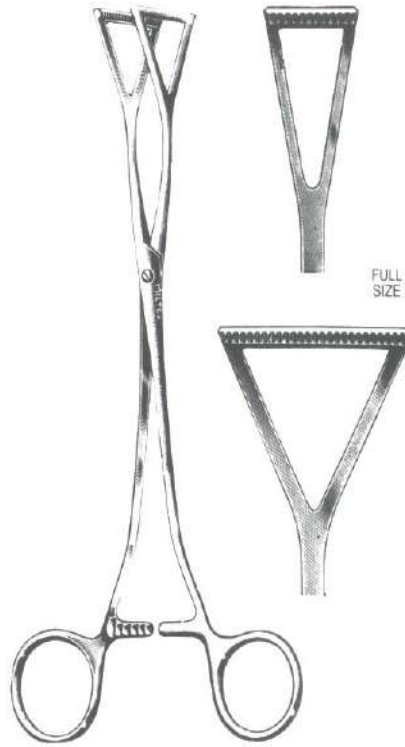

16-52
16-54
25-754



25-760

- 16-72 COLLIN-DUVAL Lung Grasping Forceps 8" (20.3 cm), with ½" (1.3 cm) wide jaws
- 16-52 COLLIN-DUVAL Lung Grasping Forceps 8" (20.3 cm), with ½" (1.3 cm) wide jaws
- 16-54 COLLIN-DUVAL Lung Grasping Forceps 8" (20.3 cm), with 1" (2.5 cm) wide jaws
- 25-754 COLLIN-DUVAL Lung Grasping Forceps 9" (22.9 cm), with 1" (2.5 cm) wide jaws
- 25-760 LOVELACE Lung Grasping Forceps 8" (20.3 cm), straight, serrated jaws 1" (2.5 cm) wide
- 14-66 LOVELACE Lung Grasping Forceps 7¼" (18.4 cm), angled shanks, serrated jaws 1" (2.5 cm) wide



14-66



- 25-782** RUMEL Thoracic Forceps 9" (22.9 cm), medium curve, 2³/₈" (6.1 cm) long jaws
- 25-784** RUMEL Thoracic Forceps 9" (22.9 cm), full curve, 2³/₈" (6.1 cm) long jaws
- 25-786** RUMEL Thoracic Forceps 9" (22.9 cm), angular, 2³/₈" (6.1 cm) long jaws
- 7-250** MOSQUITO Clamp 8¹/₄" (21 cm), straight
- 7-252** MOSQUITO Clamp 8¹/₄" (21 cm), curved
- 7-254** MOSQUITO Clamp 8¹/₄" (21 cm), angular
- 17-2603** JACOBSON Forceps 7" (17.8 cm), curved, extremely delicate
- 25-800** SAROT Intra-Thoracic Artery Forceps 9¹/₂" (24.1 cm), with 2¹/₂" (6.4 cm) long jaws
- 7-255** GEMINI-MIXTER Thoracic Forceps 5¹/₂" (14 cm), delicate full curved jaws
- 7-256** GEMINI-MIXTER Thoracic Forceps 7" (17.8 cm), delicate full curved jaws
- 7-257** GEMINI-MIXTER Thoracic Forceps 8" (20.3 cm), delicate full curved jaws
- 7-258** GEMINI-MIXTER Thoracic Forceps 9" (22.9 cm), delicate full curved jaws
- 7-259** GEMINI-MIXTER Thoracic Forceps 11" (27.9 cm), delicate full curved jaws

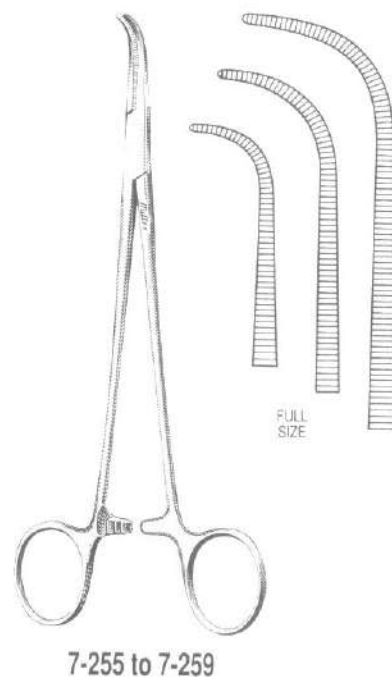

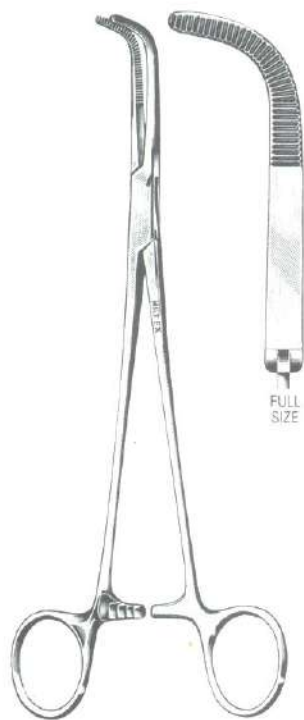

7-206



25-812
25-814

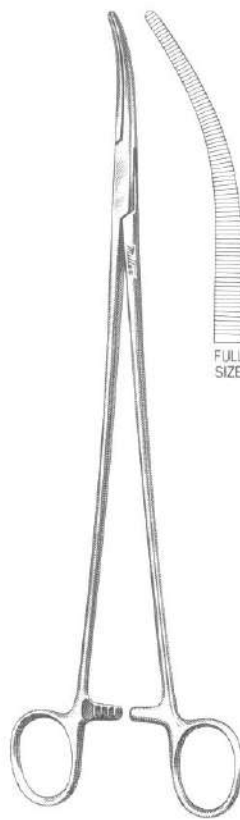

25-821

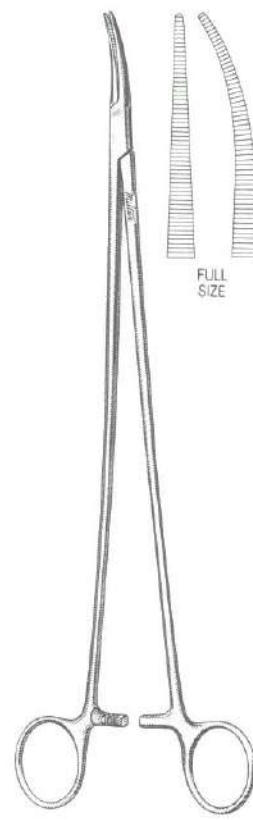

25-834
25-835

- 7-206 MIXTER Thoracic Forceps 9" (22.9 cm), full curved jaws, horizontal serrations
- 25-812 MIXTER Thoracic Forceps 9" (22.9 cm), right angle jaws, longitudinal serrations
- 25-814 MIXTER Thoracic Forceps 11" (27.9 cm), right angle jaws, longitudinal serrations
- 25-821 MILTEX Artery and Undermining Forceps 11" (27.9 cm), a delicate lightweight instrument with fine, serrated 45 mm long jaws
- 25-834 BRIDGE Deep Surgery Forceps 11" (27.9 cm), straight, very delicate
- 25-835 BRIDGE Deep Surgery Forceps 11" (27.9 cm), curved, very delicate
- 25-836 KANTROWITZ Thoracic Forceps 7½" (19.1 cm), delicate right angle jaws
- 25-837 KANTROWITZ Thoracic Forceps 9½" (24.1 cm), delicate right angle jaws
- 25-838 KANTROWITZ Thoracic Forceps 11" (27.9 cm), delicate right angle jaws

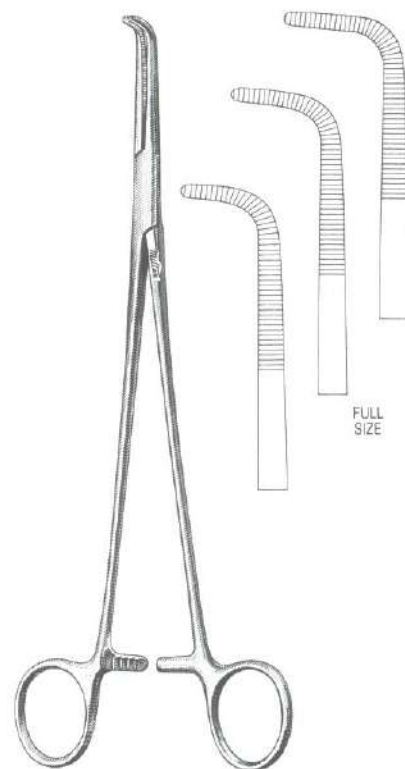

25-836 to 25-838



- 25-840** FINOCHIETTO Thoracic Forceps 9" (22.9 cm), slightly curved jaws
- 25-848** FINOCHIETTO Thoracic Forceps and Ligature Carrier 9½" (24.1 cm), angular jaws with longitudinal serrations and suture holes at tip
- 25-880** SAROT Bronchus Clamp 9" (22.9 cm), Left, adult size, 35 mm long jaws
- 25-882** SAROT Bronchus Clamp 9" (22.9 cm), Right, adult size, 35 mm long jaws
- 25-1100** SATINSKY Vascular Clamp for Vena Cava 10¾" (27.3 cm), inside jaw length 32 mm x 9 mm depth
- 25-1104** SATINSKY Vascular Clamp for Vena Cava 10¾" (27.3 cm), inside jaw length 50 mm x 13 mm depth
- 25-1108** SATINSKY Vascular Clamp for Vena Cava 6½" (27.3 cm), pediatric size, inside jaw length 32 mm x 7 mm depth
- 25-1160** CRAFOORD Coarctation Clamp 9½" (24.1 cm), slightly curved jaws 65 mm with longitudinal serrations

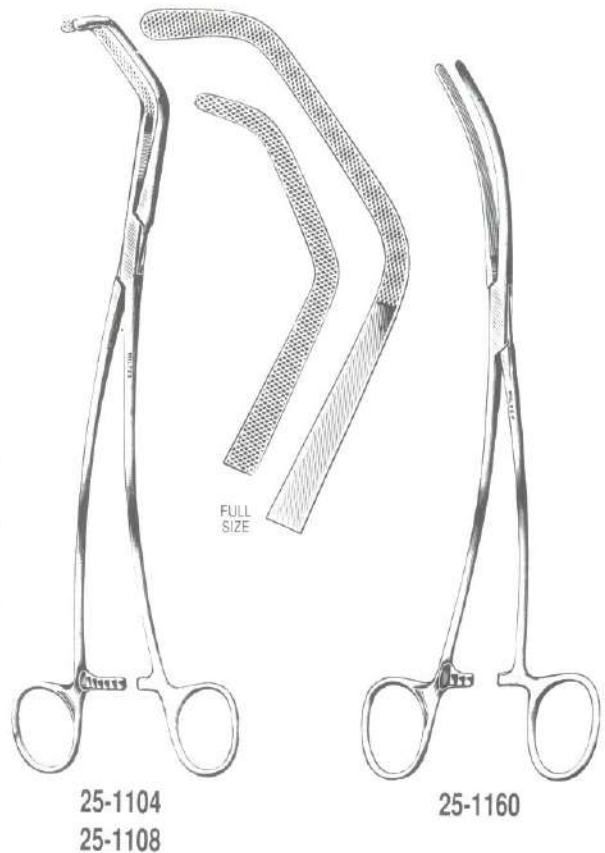

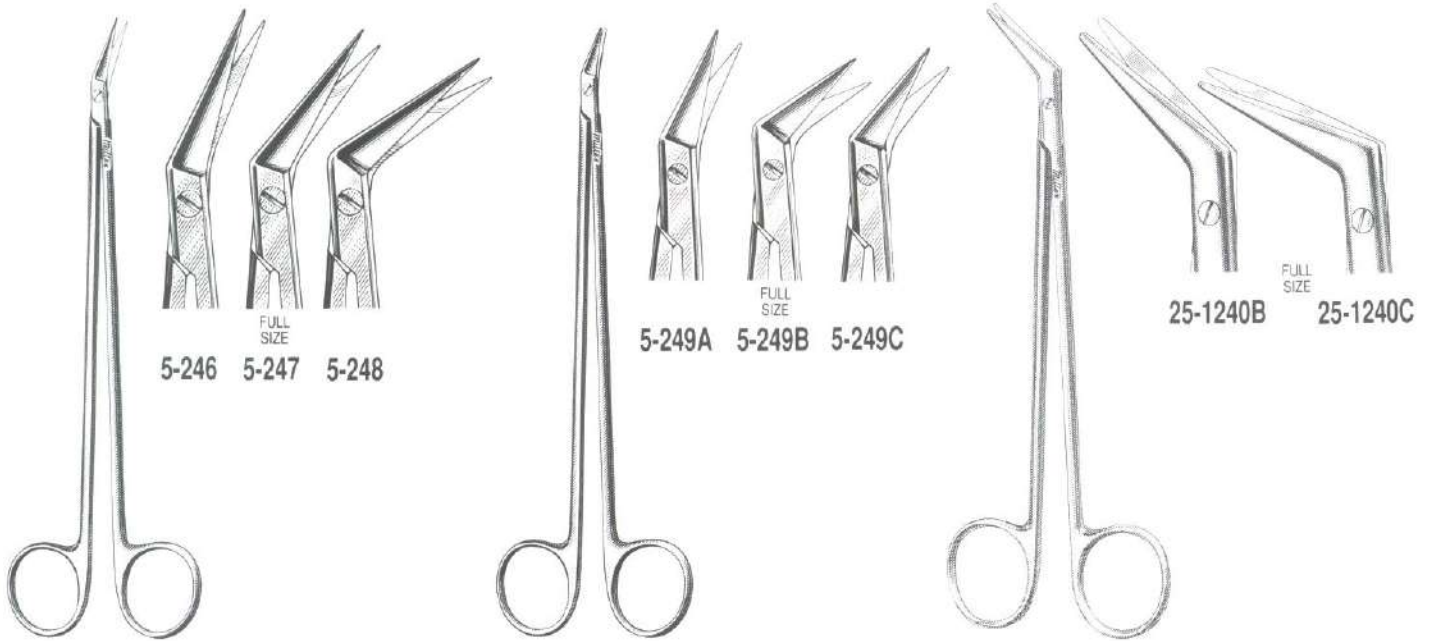

- 5-246** POTTS-SMITH Scissors 7½" (19.1 cm), angled on side 25°, 20 mm blades
- 5-247** POTTS-SMITH Scissors 7½" (19.1 cm), angled on side 45°, 20 mm blades
- 5-248** POTTS-SMITH Scissors 7½" (19.1 cm), angled on side 60°, 20 mm blades
- 5-249A** POTTS-SMITH Scissors 7" (17.8 cm), delicate, angled on side 25°, 13 mm blades
- 5-249B** POTTS-SMITH Scissors 7" (17.8 cm), delicate, angled on side 45°, 13 mm blades
- 5-249C** POTTS-SMITH Scissors 7" (17.8 cm), delicate, angled on side 60°, 13 mm blades
- 25-1240B** DeBAKEY-POTTS Scissors 6¾" (17.1 cm), blunt tips, angled on side 45°
- 25-1240C** DeBAKEY-POTTS Scissors 6¾" (17.1 cm), blunt tips, angled on side 60°
- 5-176** REYNOLDS Dissecting Scissors 7" (17.8 cm), curved tenotomy type dissecting tips
- 5-178** REYNOLDS Dissecting Scissors 7" (17.8 cm), curved, tenotomy type dissecting tips, one serrated blade



5-176
5-178



25-1280



6-154 to 6-159



6-160 to 6-164A

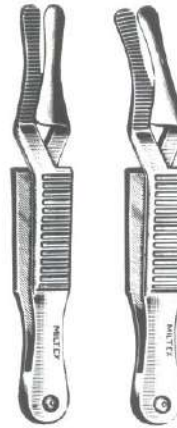

7-280 to 7-298

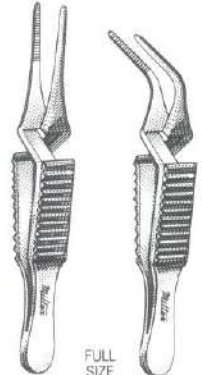

FULL SIZE
7-310
7-315

- 25-1280 SATINSKY Scissors 10" (25.4 cm), S-curved
- 6-154 POTTS-SMITH Dressing Forceps 7" (17.8 cm), serrated
- 6-156 POTTS-SMITH Dressing Forceps 8¼" (21 cm), serrated
- 6-158 POTTS-SMITH Dressing Forceps 9½" (24.1 cm), serrated
- 6-159 POTTS-SMITH Dressing Forceps 12" (30.5 cm), serrated
- 6-160 POTTS-SMITH Tissue Forceps 7" (17.8 cm), 1 x 2 teeth and serrated tips
- 6-162 POTTS-SMITH Tissue Forceps 8¼" (21 cm), 1 x 2 teeth and serrated tips
- 6-164 POTTS-SMITH Tissue Forceps 9½" (24.1 cm), 1 x 2 teeth and serrated tips
- 6-164A POTTS-SMITH Tissue Forceps 12" (30.5 cm), 1 x 2 teeth and serrated tips

JOHNS HOPKINS BULLDOG CLAMPS

Straight	Size	Curved
7-280	1½" (3.8 cm)	7-290
7-282	2" (5.1 cm)	7-292
7-284	2½" (6.4 cm)	7-294
7-286	3" (7.6 cm)	7-296
7-288	3½" (8.9 cm)	7-298

- 7-310 DIETHRICH Micro Bulldog Clamp 1⅞" (4.7 cm), straight jaws 8 mm x 1.2 mm
- 7-315 DIETHRICH Micro Bulldog Clamp 1⅞" (4.7 cm), angled jaws 8 mm x 1.2 mm
- 25-1420 Bulldog Clamp Applying Forceps 9½" (24.1 cm)



25-1420



Thoracic and Cardiovascular Instruments



8-51TC to 8-57TC

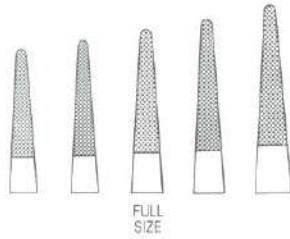

8-62TC
8-63TC



8-65TC to 8-69TC

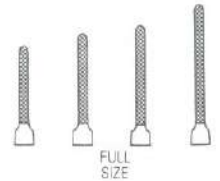

- 8-51TC CRILE-WOOD (DeBAKEY) Needle Holder 7" (17.8 cm), serrated Carb-N-Sert jaws 4000 teeth p. sq. inch
- 8-52TC CRILE-WOOD (DeBAKEY) Needle Holder 8" (20.3 cm), serrated Carb-N-Sert jaws 2600 teeth p. sq. inch
- 8-53TC CRILE-WOOD (DeBAKEY) Needle Holder 9" (22.9 cm), serrated Carb-N-Sert jaws 2600 teeth p. sq. inch
- 8-55TC CRILE-WOOD (DeBAKEY) Needle Holder 10½" (26.7 cm), serrated Carb-N-Sert jaws 2600 teeth p. sq. inch
- 8-57TC CRILE-WOOD (DeBAKEY) Needle Holder 12" (30.5 cm), serrated Carb-N-Sert jaws 2600 teeth p. sq. inch
- 8-62TC COOLEY Needle Holder 6" (15.2 cm), extra delicate, serrated Carb-N-Sert jaws 4000 teeth p. sq. inch
- 8-63TC COOLEY Needle Holder 6¼" (17.1 cm), extra delicate, serrated Carb-N-Sert jaws 4000 teeth p. sq. inch
- 8-65TC RYDER-Type Intracardiac Needle Holder 5" (12.7 cm), extra delicate, serrated Carb-N-Sert jaws 4000 teeth p. sq. inch
- 8-66TC RYDER-Type Intracardiac Needle Holder 6" (15.2 cm), extra delicate, serrated Carb-N-Sert jaws 4000 teeth p. sq. inch
- 8-67TC RYDER-Type Intracardiac Needle Holder 7" (17.8 cm), extra delicate, serrated Carb-N-Sert jaws 4000 teeth p. sq. inch
- 8-69TC RYDER-Type Intracardiac Needle Holder 9" (22.9 cm), extra delicate, serrated Carb-N-Sert jaws 4000 teeth p. sq. inch

Thoracic and Cardiovascular Instruments



8-96TC
8-114TC

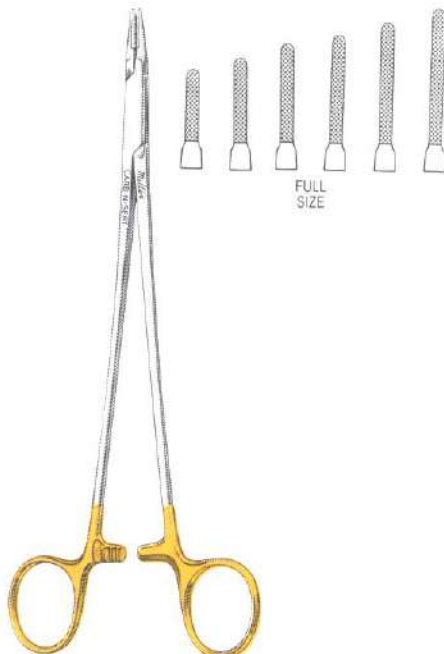

8-101TC to 8-107TC



8-134TC

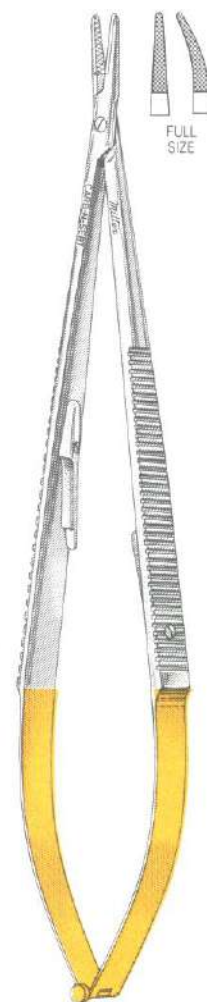

17-1090TC to 17-1092TC

- 8-96TC SAROT Needle Holder 7¼" (18.4 cm), serrated Carb-N-Sert jaws 2600 teeth p. sq. inch
- 8-114TC SAROT Needle Holder 10½" (26.7 cm), serrated Carb-N-Sert jaws 2600 teeth p. sq. inch
- 8-101TC RYDER Needle Holder 5" (12.7 cm), serrated Carb-N-Sert jaws 4000 teeth p. sq. inch
- 8-103TC RYDER Needle Holder 6" (15.2 cm), serrated Carb-N-Sert jaws 4000 teeth p. sq. inch
- 8-104TC RYDER Needle Holder 7" (17.8 cm), serrated Carb-N-Sert jaws 4000 teeth p. sq. inch
- 8-105TC RYDER Needle Holder 8" (20.3 cm), serrated Carb-N-Sert jaws 4000 teeth p. sq. inch
- 8-106TC RYDER Needle Holder 9" (22.9 cm), serrated Carb-N-Sert jaws 4000 teeth p. sq. inch
- 8-107TC RYDER Needle Holder 10¼" (26 cm), serrated Carb-N-Sert jaws 4000 teeth p. sq. inch
- 8-134TC WANGENSTEEN Needle Holder 10¾" (27.3 cm), serrated Carb-N-Sert jaws 2600 teeth p. sq. inch
- 17-1090TC JACOBSON Microvascular Needle Holder 7" (17.8 cm), straight, with lock, serrated Carb-N-Sert jaws 16000 teeth p. sq. inch
- 17-1091TC JACOBSON Microvascular Needle Holder 7" (17.8 cm), curved, with lock, serrated Carb-N-Sert jaws 16000 teeth p. sq. inch
- 17-1092TC JACOBSON Microvascular Needle Holder 8½" (21.6 cm), straight, with lock, serrated Carb-N-Sert jaws 16000 teeth p. sq. inch



26-2



26-16



26-18



26-20



26-24

26-2 CUSHING Perforator Drill 1/2" (1.3 cm) diameter

26-16 McKENZIE Perforator Drill, 13 mm diameter

26-18 McKENZIE Enlarging Bur, 16 mm diameter

26-20 D'ERRICO Perforator and Enlarging Bur, 16 mm diameter

Above Burs and Drills will fit Hudson Braces

26-24 HUDSON Cerebellar Extension 4" (10.2 cm), for use with Hudson Braces



26-33-1 to 26-33-4

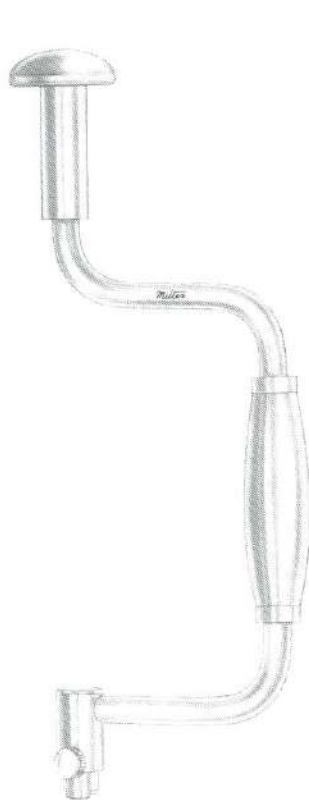

26-30
26-32

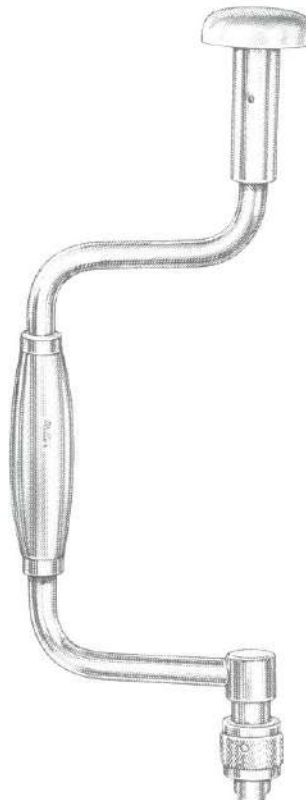

26-35

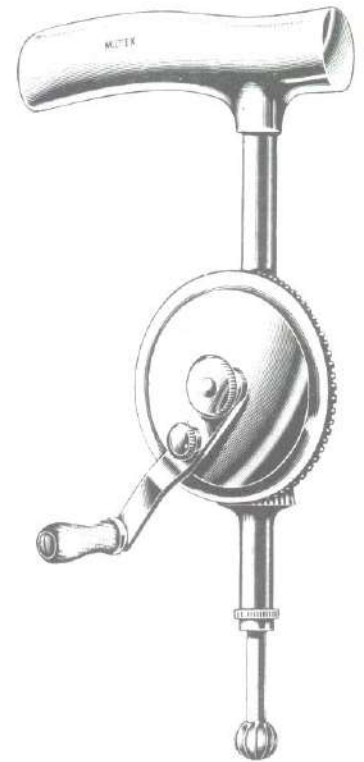

26-40
26-42

- 26-33-1 HUDSON Bur, 9 mm diameter
- 26-33-2 HUDSON Bur, 14 mm diameter
- 26-33-3 HUDSON Bur, 16 mm diameter
- 26-33-4 HUDSON Bur, 22 mm diameter

- 26-30 HUDSON Brace Set, standard thumbscrew chuck, complete with 4 Burs (1 ea. Nos. 26-33-1 through 4)
- 26-32 HUDSON Brace 10½" (26.7 cm), with standard thumbscrew chuck
- 26-35 HUDSON Brace 11" (27.9 cm), with improved snap-lock chuck

- 26-40 STILLE Pattern Cranial Drill Set, complete with 4 twist drills (2.5 to 4 mm), 4 burs (4 to 16 mm) and 1 trephine (10 mm). Chrome plated drill, stainless points.
- 26-42 STILLE Pattern Cranial Drill 10" (25.4 cm), chrome plated



26-44



26-48



26-46

Replacement Points for Stille Pattern Drills

Twist Drills		Round Burs	
26-44-1	2.5 mm	26-46-1	4 mm
26-44-2	3 mm	26-46-2	8 mm
26-44-3	3.5 mm	26-46-3	11 mm
26-44-4	4 mm	26-46-4	16 mm
26-48	Trephine 10 mm dia.		

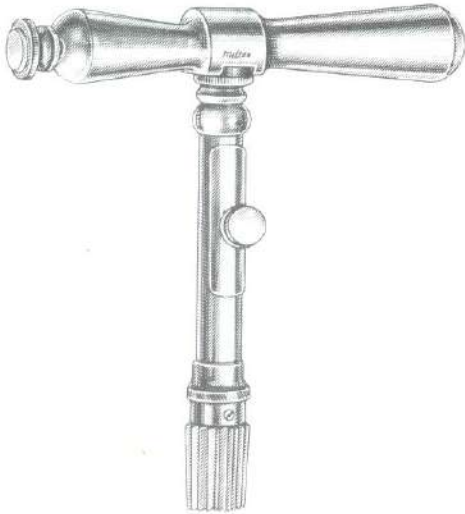

26-28A to 26-28E

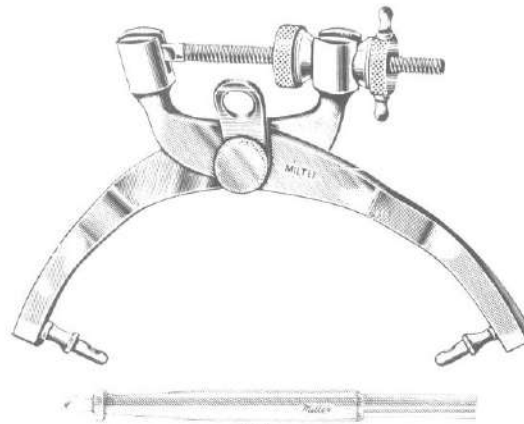

FULL
SIZE
26-60
26-62



11-2

GALT SKULL TREPHINES, with Removable Handle For Use With Hudson Brace (26-30), Chrome Plated. Cutters and Adjustable Centering Points are Stainless

- | | | | |
|--------|--------------------|--------|--------------------|
| 26-28A | 1/2" (1.3 cm) dia. | 26-28D | 7/8" (2.2 cm) dia. |
| 26-28B | 5/8" (1.6 cm) dia. | 26-28E | 1" (2.5 cm) dia. |
| 26-28C | 3/4" (1.9 cm) dia. | | |

- 26-60 RANEY-CRUTCHFIELD Skull Traction Tong 120 mm spread, incl. 2 drill points
 26-62 RANEY-CRUTCHFIELD Drill Point

- 11-2 JANSEN Retractor 4 1/4" (10.8 cm), spread 3" (7.6 cm), 3 x 3 blunt prongs, 10 mm deep
 11-4 JANSEN Scalp Retractor 4 1/4" (10.8 cm), spread 3" (7.6 cm), 4 x 4 blunt prongs, 20 mm deep
 11-8 JANSEN-WAGNER Retractor 5" (12.7 cm), 5 x 5 sharp prongs, self adjusting

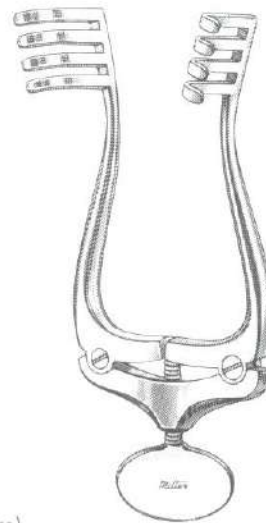

11-4

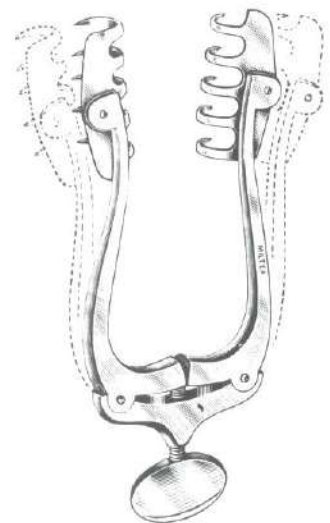

11-8

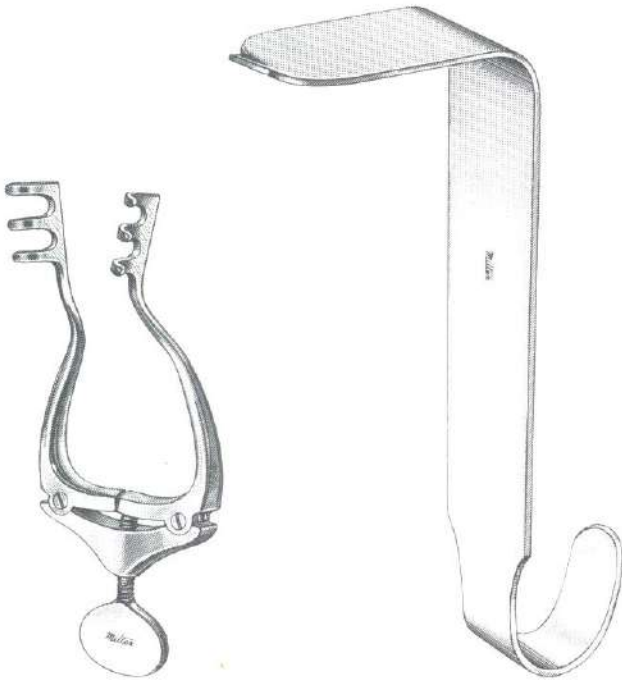

11-10

26-91
26-92

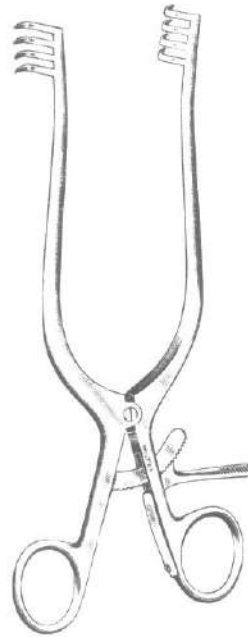

11-700

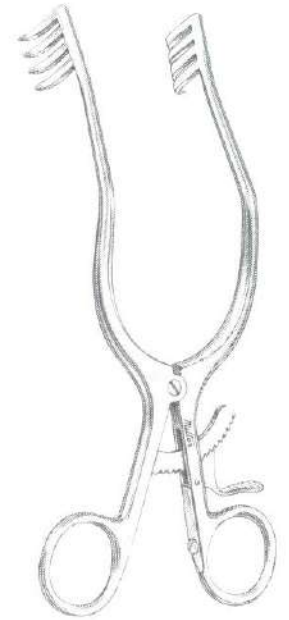

11-702

- 11-10** DAVIS Scalp Retractor 4½" (11.4 cm), 3 x 3 blunt prongs 10 mm deep
- 26-91** TAYLOR Spinal Retractor 7¼" (18.4 cm), blade 1¼" (3.2 cm) x 3" (7.6 cm)
- 26-92** TAYLOR Spinal Retractor 7¼" (18.4 cm), blade 1¼" (3.2 cm) x 4" (10.2 cm)
- 11-700** ADSON Cerebellar Retractor 7½" (19.1 cm), 4 x 4 teeth ¾" (1.9 cm) x ¾" (1.9 cm), straight arms
- 11-702** ADSON Cerebellar Retractor 7½" (19.1 cm), 4 x 4 teeth ¾" (1.9 cm) x ¾" (1.9 cm), angled arms

BECKMAN-WEITLANER RETRACTORS, with hinged blades, 3 x 4 teeth

Sharp	Size	Blunt
11-630-SH	5½" (14 cm)	11-630-BL (Cone Scalp Retr.)
11-634-SH (Cone Lamin. Retr.)	6½" (16.5 cm)	11-634-BL
11-642-SH (Cone Lamin. Retr.)	9" (22.9 cm)	11-642-BL

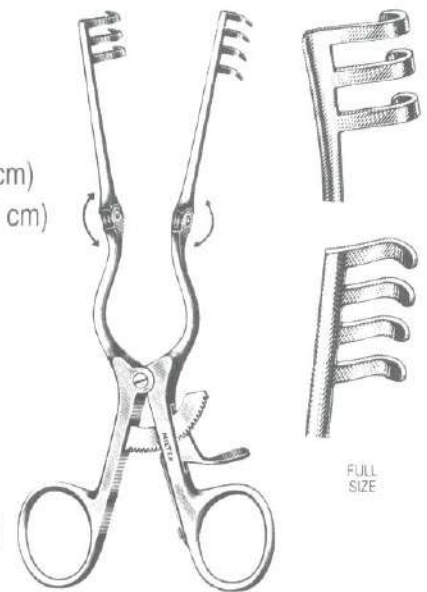

11-630 to 11-642

FULL SIZE

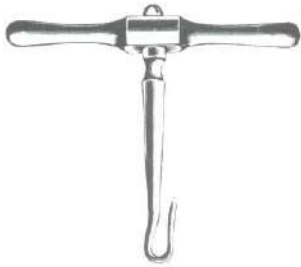

26-119



26-120



26-122



26-124



26-130 to 26-134



26-138

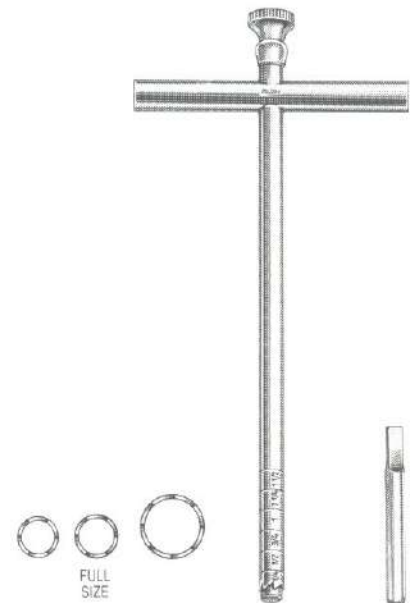

26-140 to 26-143

- ✓ 26-119 GIGLI Saw Handle, Standard Pattern, T-Shaped, turnable
- 26-120 GIGLI-STRULLY Saw Handle, Standard Pattern, T-Shape, rigid, with snap-lock
- ✓ 26-122 GIGLI-STRULLY Saw Handle, Standard Pattern, T-Shape, turnable, with snap-lock
- ✓ 26-124 GIGLI-STRULLY Saw Handle, Standard Pattern, Loop Grip, rigid, with snap-lock

- 26-130 GIGLI Saw 12" (30.5 cm), Standard twisted wire type
- 26-132 GIGLI Saw 20" (50.8 cm), Standard twisted wire type
- 26-134 GIGLI Saw 30" (76.2 cm), Standard twisted wire type

- ✓ 26-138 BAILEY GIGLI Saw Guide 12" (30.5 cm), flexible

- 26-140 MICHELE Trephine 6 1/4" (15.9 cm) shaft, 3/16" (.47 cm) O.D., graduated 1/4" (.64 cm) to 1 1/4" (3.2 cm)
- 26-141 MICHELE Trephine 6 1/4" (15.9 cm) shaft, 7/32" (.56 cm) O.D., graduated 1/4" (.64 cm) to 1 1/4" (3.2 cm)
- 26-142 MICHELE Trephine 6 1/4" (15.9 cm) shaft, 5/16" (.79 cm) O.D., graduated 1/4" (.64 cm) to 1 1/4" (3.2 cm)
- 26-143 Marker for No. 26-142 Michele Trephine

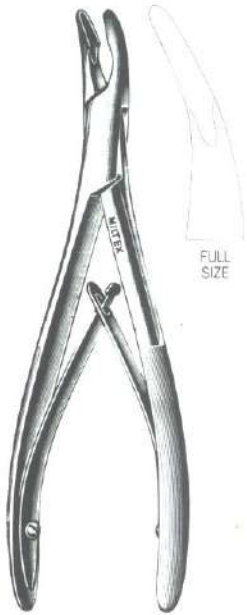

19-808



26-190
26-192



26-198



26-200

- 19-808 BANE Rongeur 7" (17.8 cm), curved
- 26-190 LUER Rongeur 7" (17.8 cm), straight jaws 8 mm bite
- 26-192 LUER Rongeur 7" (17.8 cm), curved jaws 8 mm bite
- 26-198 BACON Rongeur 8¼" (21 cm), angled on side, 5 mm bite
- 26-200 STOOKEY Rongeur 7¾" (19.7 cm), angled on side, 3 mm bite
- 26-220 ADSON Cranial Rongeur 8" (20.3 cm), straight jaws 7 x 13 mm
- 26-222 ADSON Cranial Rongeur 8" (20.3 cm), curved jaws 7 x 13 mm

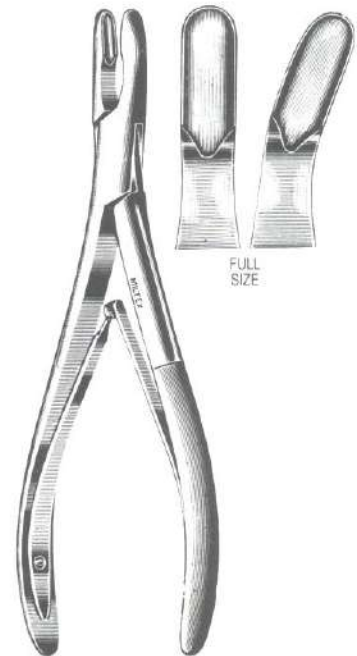

26-220
26-222

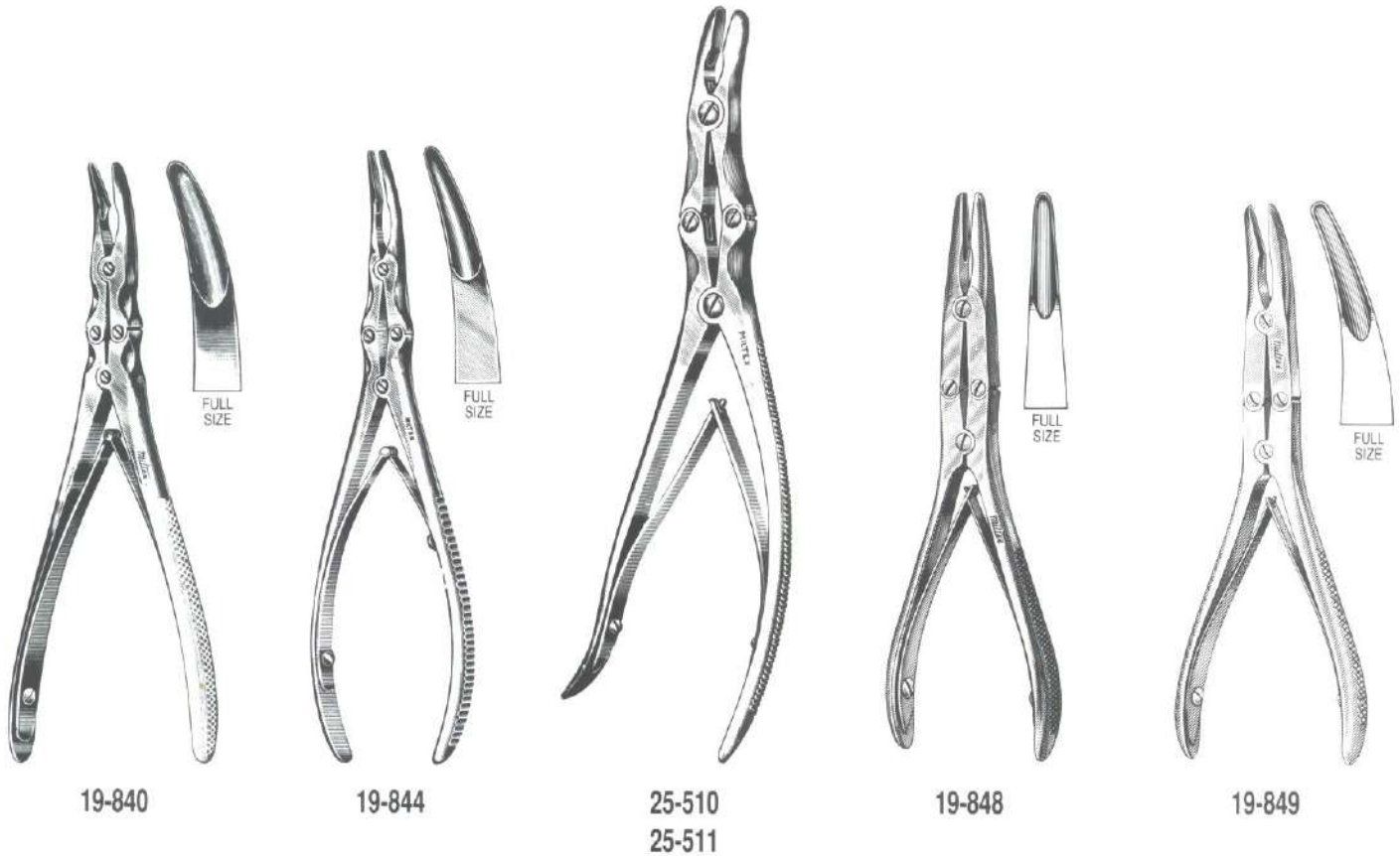

19-840 ZAUFEL-JANSEN Rongeur 7" (17.8 cm), slightly curved jaws 5 mm wide

19-844 BEYER Rongeur 7" (17.8 cm), slightly curved jaws 3.5 mm wide

25-510 LEKSELL Laminectomy Rongeur 9½" (24.1 cm), standard curve, 3 mm bite

25-511 LEKSELL Laminectomy Rongeur 9½" (24.1 cm), standard curve, 8 mm bite

RUSKIN RONGEURS

Straight Jaws

Size

Curved Jaws

19-848 6" (15.2 cm) long, 3 mm bite

19-849

19-850 7¼" (18.4 cm) long, 5 mm bite

19-852

19-854 7¼" (18.4 cm) long, 7 mm bite

19-856

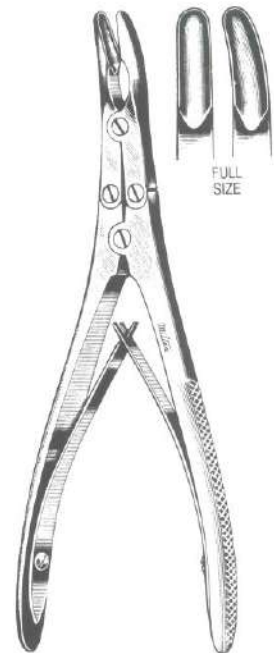

19-850 to 19-856

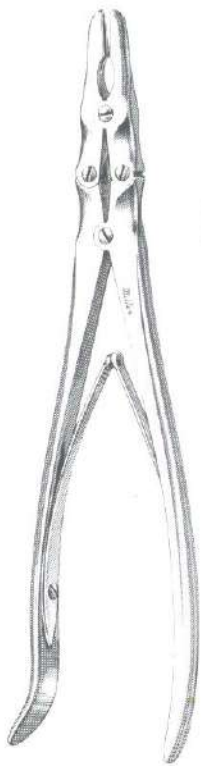

26-255 to 26-258

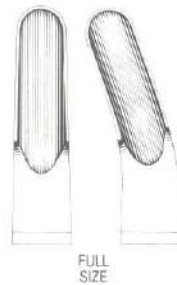
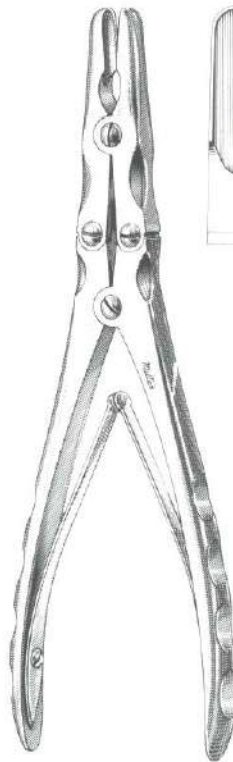

26-261
26-262

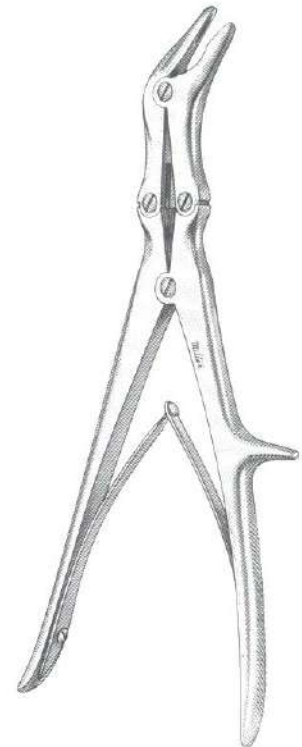

26-264 to 26-266

- 26-255 SMITH-PETERSEN Laminectomy Rongeur 7½" (19.1 cm), straight jaws, 3 mm bite
- 26-256 SMITH-PETERSEN Laminectomy Rongeur 7½" (19.1 cm), slightly curved jaws, 3 mm bite
- 26-258 SMITH-PETERSEN Laminectomy Rongeur 9½" (24.1 cm), straight jaws, 3 mm bite
- R 26-261 FULTON Laminectomy Rongeur 9½" (24.1 cm), straight jaws 7 x 18 mm
- C 26-262 FULTON Laminectomy Rongeur 9½" (24.1 cm), slightly curved jaws 7 x 18 mm
- 26-264 ECHLIN Duckbill Rongeur 9" (22.9 cm), 2 mm bite
- 26-265 ECHLIN Duckbill Rongeur 9" (22.9 cm), 3 mm bite
- 26-266 ECHLIN Duckbill Rongeur 9" (22.9 cm), 4 mm bite

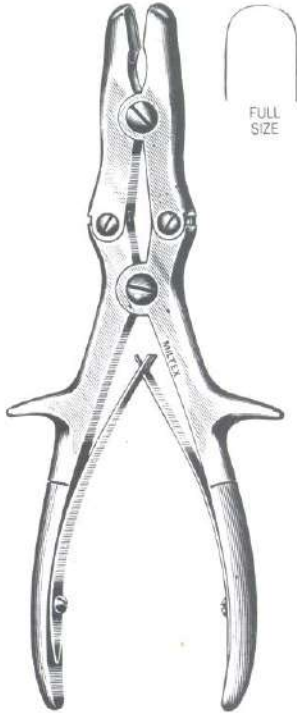

25-454

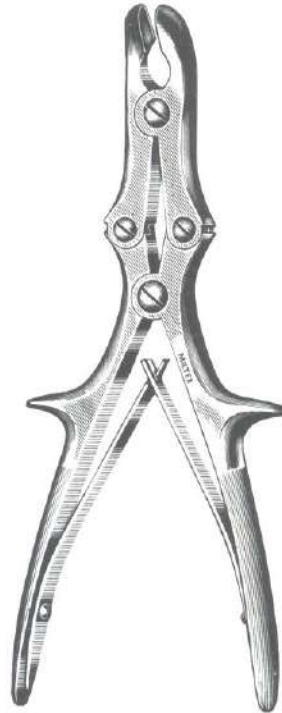

25-456

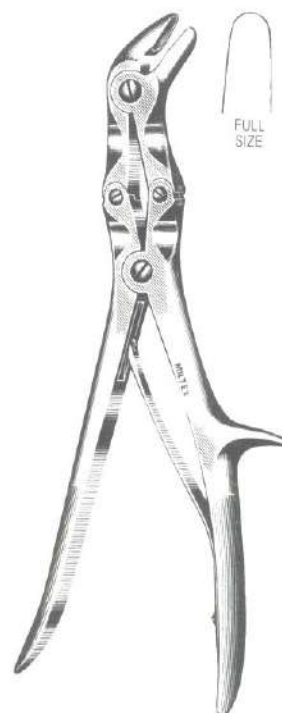

25-458

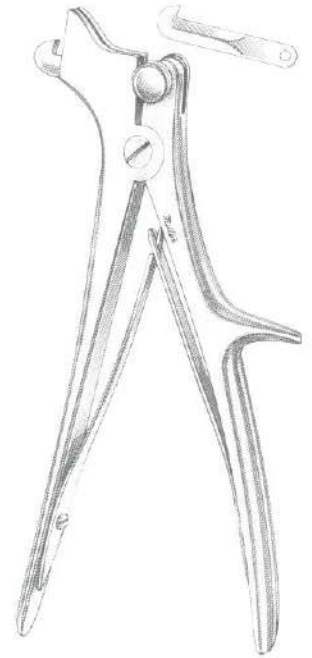

26-270

- 25-454 STILLE-LUER Rongeur 8³/₄" (22.2 cm), straight jaws 9 x 15 mm
- 25-456 STILLE-LUER Rongeur 8³/₄" (22.2 cm), curved jaws 9 x 15 mm
- 25-458 STILLE-LUER Duckbill Rongeur, 9" (22.9 cm), angled on side jaws 6 x 12 mm
- 26-270 DeVILBISS Cranial Rongeur 8¹/₄" (21 cm), with 2 blades



20-660
20-662

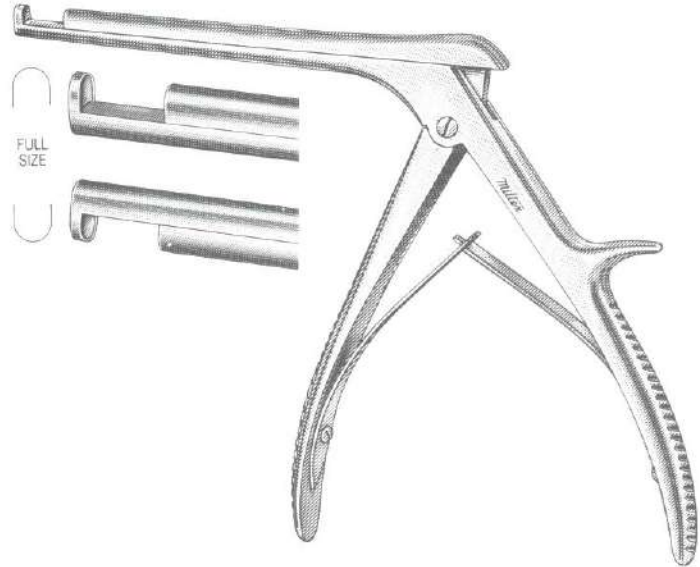

26-326 to 26-329

- 20-660 HAJEK-KOFLER Laminectomy Rongeur 5" (12.7 cm) shaft, up-bite, 4 x 5 mm
- 20-662 HAJEK-KOFLER Laminectomy Rongeur 5" (12.7 cm) shaft, down-bite, 4 x 5 mm

SCHLESINGER CERVICAL RONGEURS, THIN TIPS,
6" (15.2 cm) SHAFT

	Up-Bite		Down-Bite
26-326	3 mm	26-328	3 mm
26-327	5 mm	26-329	5 mm

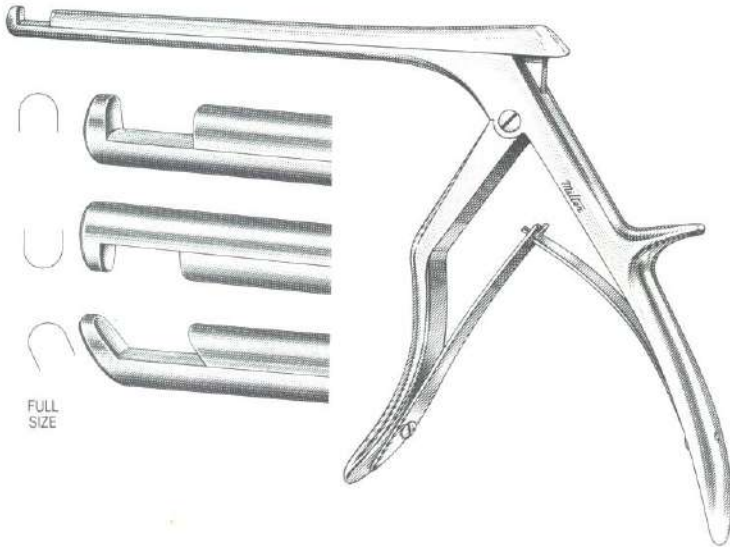

26-330 to 26-339B

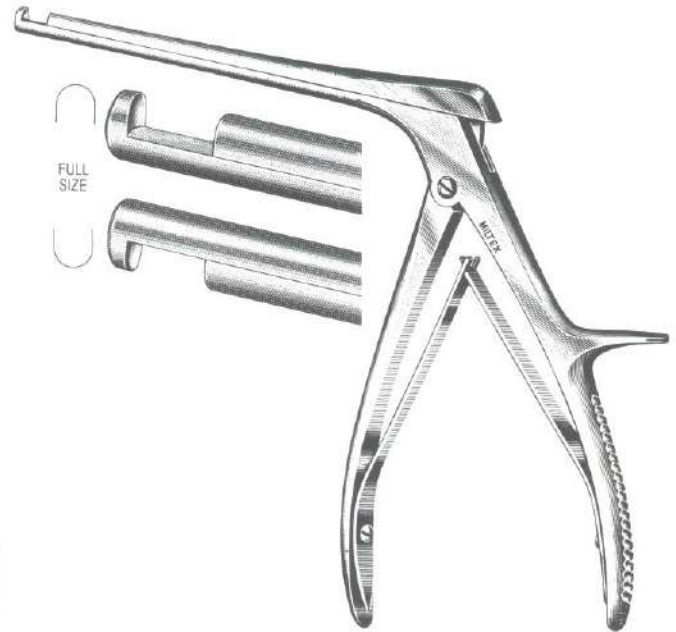

26-340 to 26-370

SPURLING-KERRISON CERVICAL RONGEURS

Up-Bite		Down-Bite		40° Forward Angle	
		6" (15.2 cm) Shaft			
26-330	3 mm	26-332	3 mm	26-334	3 mm
26-331	5 mm	—	—	26-335	5 mm
		8" (20.3 cm) Shaft			
26-336	3 mm	26-338	3 mm	26-339A	3 mm
26-337	5 mm	—	—	26-339B	5 mm

LOVE-KERRISON CERVICAL RONGEURS

Up-Bite		Down-Bite	
		6" (15.2 cm) Shaft	
26-340	3 mm	26-370	3 mm

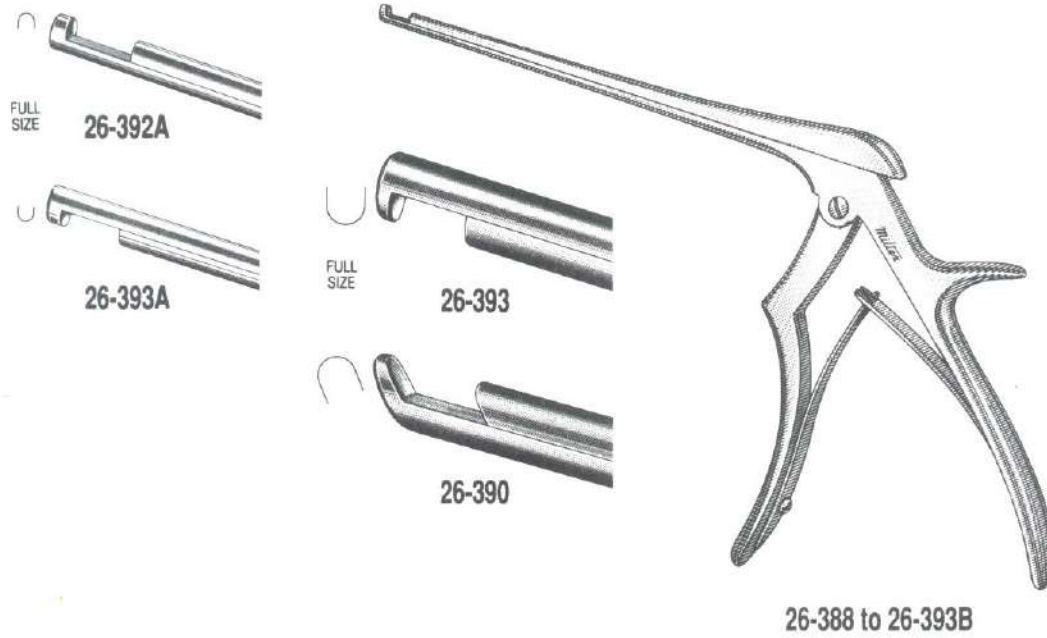

MILTEX-KERRISON CERVICAL RONGEURS
7" (17.8 cm) SHAFT, IMPROVED HANDLE

	2 mm	3 mm	5 mm
Up-Bite	26-392A	26-392B	26-392
Down-Bite	26-393A	26-393B	26-393
40° Forward Angle	26-388	26-389	26-390

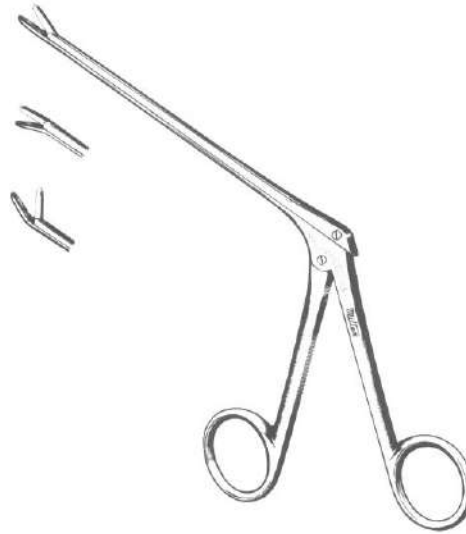

26-394 to 26-437

CUSHING PITUITARY RONGEURS 2 x 10 mm CUP JAWS

	Straight	Curved-Up	Curved-Down
5" (12.7 cm) Shank	26-394	26-395	26-396
7" (17.8 cm) Shank	26-397	26-398	26-399

LOVE-GRUENWALD PITUITARY RONGEURS 3 x 10 mm CUP JAWS

	Straight	Curved-Up	Curved-Down
5" (12.7 cm) Shank	26-400	26-410	26-420
7" (17.8 cm) Shank	26-402	26-412	26-422

SPURLING PITUITARY RONGEURS 4 x 10 mm CUP JAWS

	Straight	Curved-Up	Curved-Down
5" (12.7 cm) Shank	26-430	—	—
7" (17.8 cm) Shank	26-435	26-436	26-437



26-440

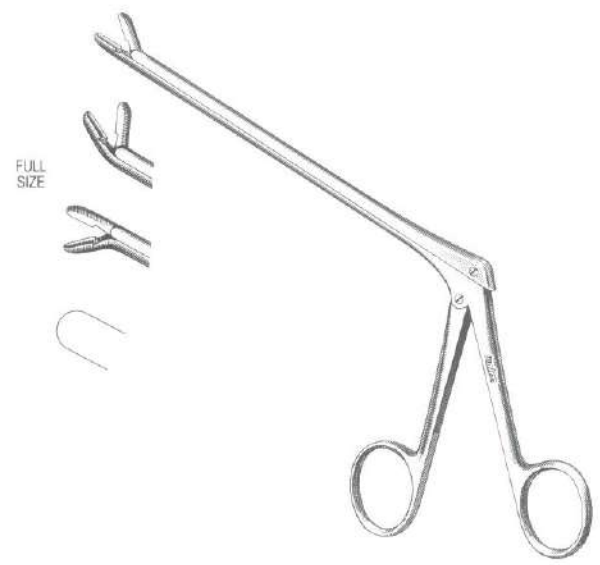

26-480 to 26-482

26-440

OLDBERG Pituitary Rongeur 7" (17.8 cm) Shank, round cup jaws 6 mm dia.

CLOWARD PITUITARY RONGEURS 6 x 10 mm CUP JAWS, 6" (15.2 cm) SHANKS

Straight	Curved-Up	Curved-Down
26-480	26-481	26-482

SCHLESINGER PITUITARY RONGEURS, SERRATED CUP JAWS, STRAIGHT 6" (15.2 cm) SHANKS

26-483	2 x 10 mm bite
26-484	3 x 10 mm bite
26-485	4 x 10 mm bite



26-483 to 26-485

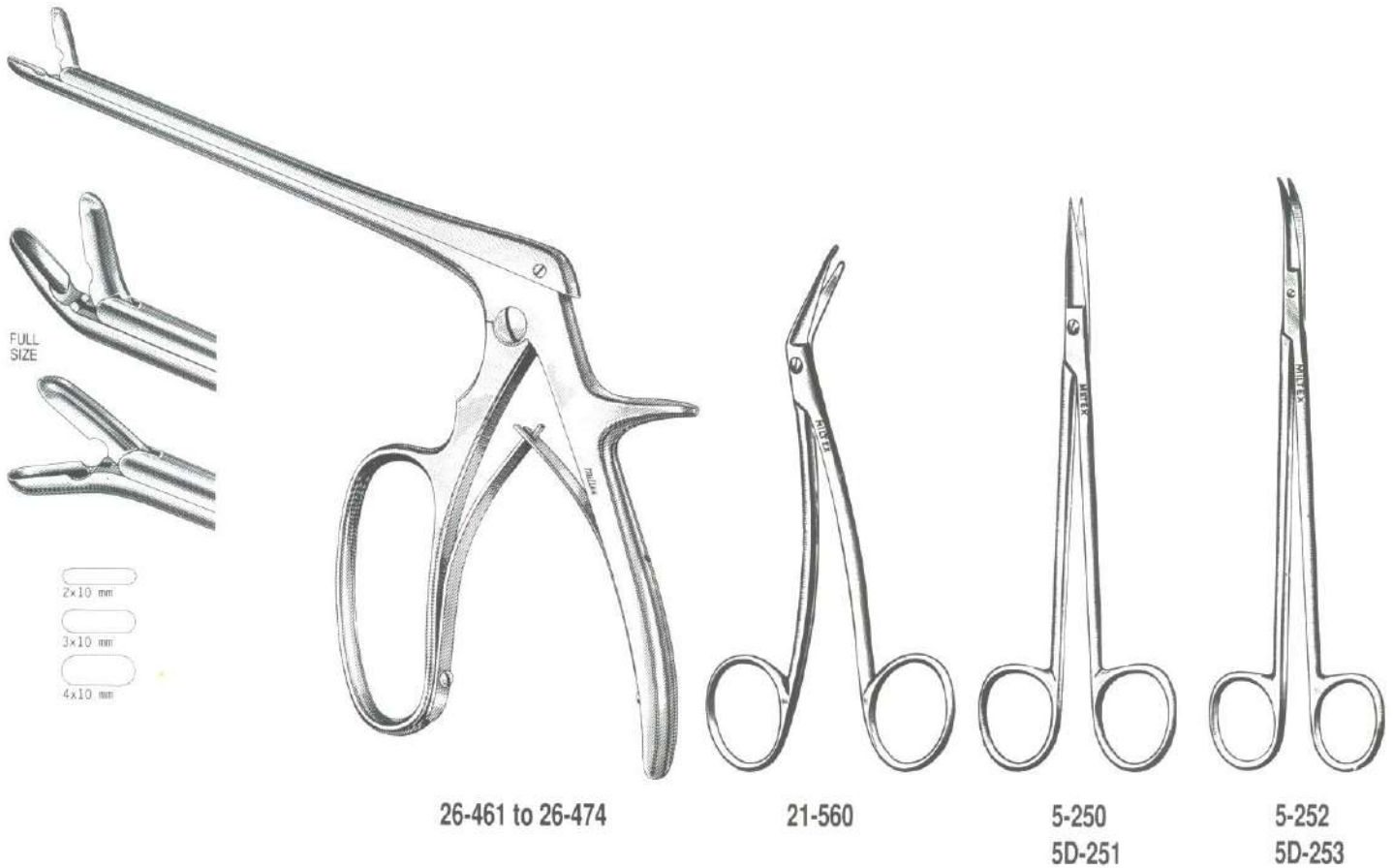

FERRIS-SMITH PITUITARY CUP JAW RONGEURS, 7" (17.8 cm) SHANK

	Straight	Curved-Up	Curved-Down
2 x 10 mm Jaws	—	—	26-470
3 x 10 mm Jaws	26-461	26-466	26-471
4 x 10 mm Jaws	26-462	—	26-472
6 x 12 mm Jaws	26-474 (Cloward Patt.)	—	—

- 21-560** TAYLOR Dural Scissors 5½" (14 cm), with probe tip
- 5-250** KELLY (ADSON) Ganglion Scissors 6¼" (15.9 cm), straight, sharp points
- 5D-251** KELLY (ADSON) Ganglion Scissors 6¼" (15.9 cm), straight, sharp points, with one serrated blade
- 5-252** KELLY (ADSON) Ganglion Scissors 6¼" (15.9 cm), curved, sharp points
- 5D-253** KELLY (ADSON) Ganglion Scissors 6¼" (15.9 cm), curved, sharp points, with one serrated blade
- 5-262** STRULLY Neurological Scissors 8" (20.3 cm), slightly curved blades with probe tips

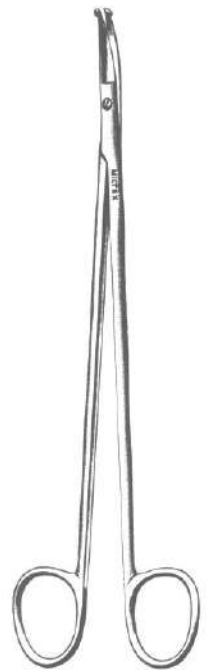

5-262

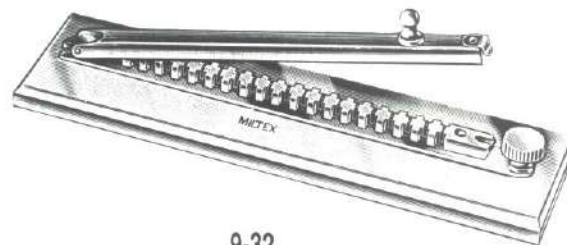

9-32

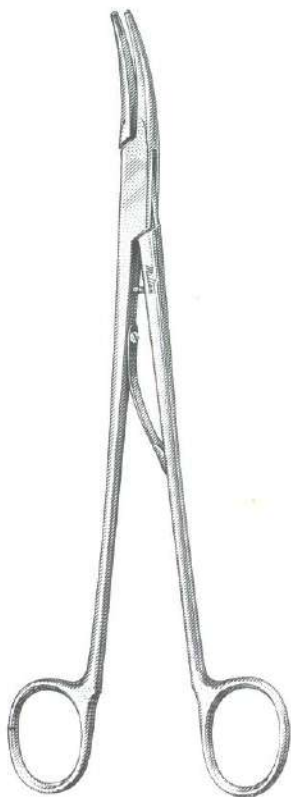

9-74



9-80

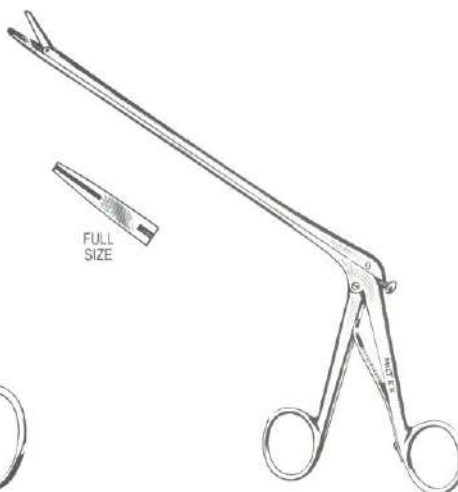

9-90

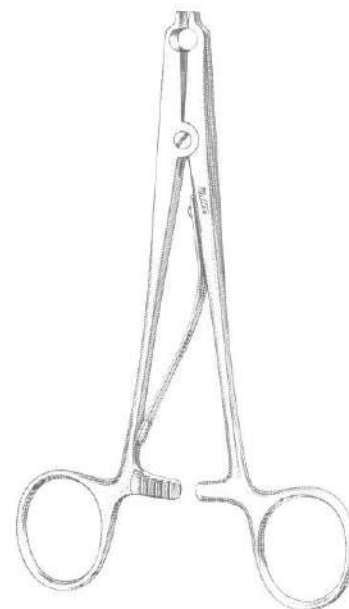

26-590

- 9-32 McKENZIE Brain Clip Holding Rack, for 20 clips
- 9-74 SMITHWICK Clip Applying Forceps 9" (22.9 cm), curved jaws, straight handles
- 9-80 McKENZIE Clip Applying Forceps 6" (15.2 cm), curved jaws, straight handles
- 9-90 SCOVILLE Clip Applying Forceps, 6" (15.2 cm) shaft
- 26-590 RANEY Scalp Clip Applying Forceps 6 1/4" (15.9 cm)
- 26-591 RANEY Reusable Scalp Clips, black finish



26-591

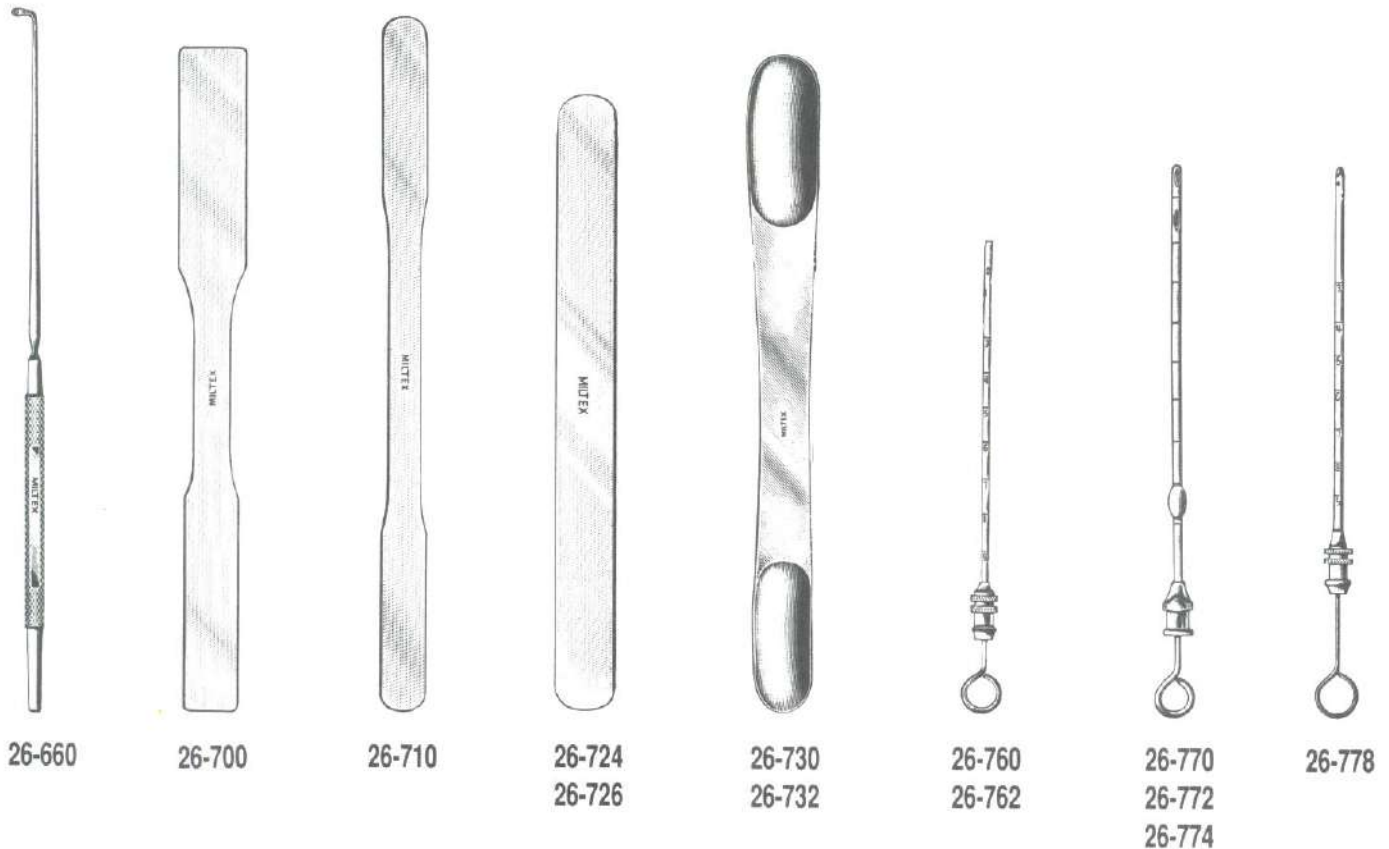

- 26-660 ADSON Aneurysm Needle 9" (22.9 cm)
- 26-700 SCOVILLE Spatula 8" (20.3 cm), malleable ends $\frac{5}{8}$ " (1.6 cm) and $\frac{7}{8}$ " (2.2 cm) wide
- 26-710 CHILDREN'S HOSPITAL Spatula 8 $\frac{1}{2}$ " (21.6 cm), malleable, ends are $\frac{1}{2}$ " (1.3 wide), silver plated
- 26-724 DAVIS Spatula 7" (17.8 cm) x $\frac{1}{2}$ " (1.3 cm), nickel silver, malleable
- 26-726 DAVIS Spatula 7" (17.8 cm) x $\frac{3}{4}$ " (1.9 cm), nickel silver, malleable
- 26-730 CUSHING Spatula Spoon 6 $\frac{3}{4}$ " (17.1 cm), spoon ends $\frac{1}{2}$ " (1.3 cm) and $\frac{3}{4}$ " (1.9 cm) wide
- 26-732 CUSHING Spatula Spoon 7 $\frac{3}{4}$ " (19.7 cm), spoon ends $\frac{3}{4}$ " (1.9 cm) and 1" (2.5 cm) wide
- 26-760 ADSON Cannula 9 Fr. (3 mm), 10 cm graduated in cm, open end, sterling
- 26-762 ADSON Cannula 9 Fr. (3 mm), 14 cm graduated in cm, open end, sterling
- 26-770 ELSBERG Cannula 11 cm, 3-hole closed end, 5 Fr., (1.7 mm), Luer lock, sterling
- 26-772 ELSBERG Cannula 11 cm, 3-hole closed end, 7 Fr., (2.3 mm), Luer lock, sterling
- 26-774 ELSBERG Cannula 11 cm, 3-hole closed end, 9 Fr., (3 mm), Luer lock, sterling
- 26-778 FRAZIER Needle 9 cm, 3-hole closed blunt trocar point, 9 Fr. (3 mm)



26-780
26-782



19-562 to 19-565



19-570 to 19-577



19-580
19-582
19-584

- 26-780 ADSON Suction Tube 6" (15.2 cm), with finger valve and obturator, 11 Fr. (3.6 mm)
- 26-782 ADSON Suction Tube 8" (20.3 cm), with finger valve and obturator, 15 Fr. (5 mm)

HOUSE SUCTION - IRRIGATING TUBES, 9 cm working length

- 19-562 1.8 mm Suction Tube and 1.8 mm Irrigating Tube
- 19-563 2.5 mm Suction Tube and 2 mm Irrigating Tube
- 19-564 3 mm Suction Tube and 2 mm Irrigating Tube
- 19-565 4.5 mm Suction Tube and 2 mm Irrigating Tube

FRAZIER SUCTION TUBES, with finger cut-off, angled

- | | | | |
|--------|-------------------|--------|--------------------|
| 19-570 | 6 French (2 mm) | 19-575 | 10 French (3.3 mm) |
| 19-572 | 7 French (2.3 mm) | 19-576 | 11 French (3.6 mm) |
| 19-573 | 8 French (2.6 mm) | 19-577 | 12 French (4 mm) |
| 19-574 | 9 French (3 mm) | | |

- 19-580 BARON Suction Tube, 3 French (1 mm), with finger cut-off
- 19-582 BARON Suction Tube, 5 French (1.7 mm), with finger cut-off
- 19-584 BARON Suction Tube, 7 French (2.3 mm), with finger cut-off

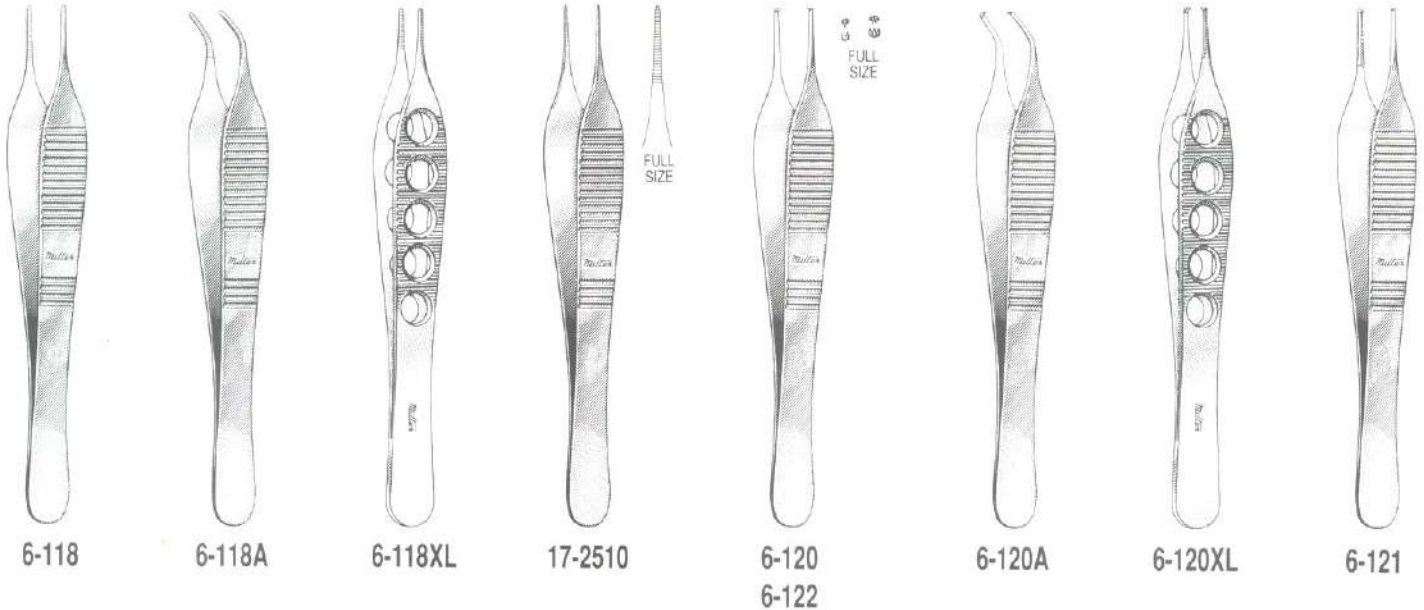

- 6-118** ADSON Dressing Forceps 4¾" (12.1 cm), serrated, delicate
- 6-118A** ADSON Dressing Forceps 4¾" (12.1 cm), serrated, delicate, angled
- 6-118XL** ADSON Dressing Forceps 4¾" (12.1 cm), serrated, lightweight, fenestrated handles
- 17-2510** Micro ADSON Dressing Forceps 4¾" (12.1 cm), serrated tips, 0.5 mm wide
- 6-120** ADSON Tissue Forceps 4¾" (12.1 cm), 1 x 2 teeth, delicate
- 6-120A** ADSON Tissue Forceps 4¾" (12.1 cm), 1 x 2 teeth, delicate, angled
- 6-120XL** ADSON Tissue Forceps 4¾" (12.1 cm), 1 x 2 teeth, lightweight, fenestrated handles
- 6-121** ADSON Tissue Forceps 4¾" (12.1 cm), 1 x 2 teeth and cross serrated tips, delicate
- 17-2500** Micro ADSON Tissue Forceps 4¾" (12.1 cm), tips 0.5 mm wide, 1 x 2 teeth
- 6-122** ADSON Tissue Forceps 4¾" (12.1 cm), 2 x 3 teeth, delicate
- 6-123** ADSON Tissue and Suture Forceps 4¾" (12.1 cm), 1 x 2 teeth with tying platform
- 6-123XL** ADSON Tissue Forceps 4¾" (12.1 cm), w/platform, 1 x 2 teeth, lightweight, fenestrated handles

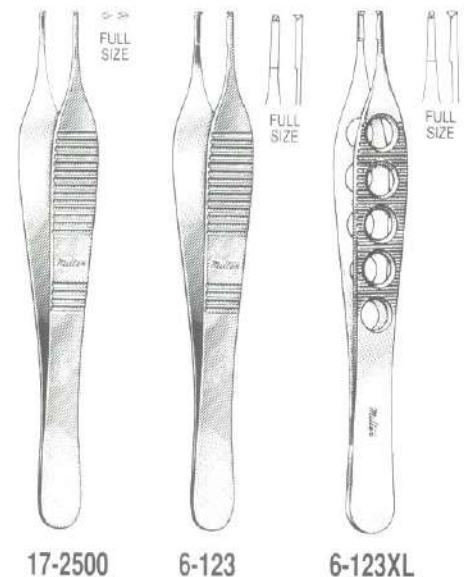



6-124

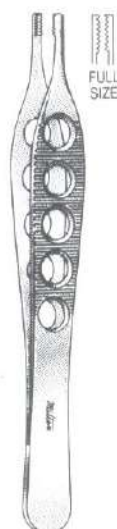

6-124XL



6-126



6-104
6-109



6-106
6-108
6-109A



6-107



6-166



6-168

- 6-124 BROWN-ADSON Tissue Forceps 4¾" (12.1 cm), 7 x 7 side grasping teeth
- 6-124XL BROWN-ADSON Tissue Forceps 4¾" (12.1 cm), 7 x 7 side grasping teeth, lightweight, fenestrated handles
- 6-126 BROWN-ADSON Tissue Forceps 4¾" (12.1 cm), 7 x 7 side grasping teeth, angular
- 6-104 SEMKEN Dressing Forceps 5" (12.7 cm), serrated
- 6-106 SEMKEN Tissue Forceps 5" (12.7 cm), 1 x 2 teeth
- 6-107 SEMKEN Tissue Forceps 5" (12.7 cm), 1 x 2 teeth, curved tips
- 6-108 SEMKEN Tissue Forceps 5" (12.7 cm), 2 x 3 teeth
- 6-109 SEMKEN Dressing Forceps 6" (15.2 cm), serrated
- 6-109A SEMKEN Tissue Forceps 6" (15.2 cm), 1 x 2 teeth
- 6-166 CUSHING Dressing Forceps 7" (17.8 cm), serrated, Gutch handle, dissecting end
- 6-168 CUSHING Tissue Forceps 7" (17.8 cm), 1 x 2 teeth, Gutch handle, dissecting end
- 6-188 CUSHING Dressing Forceps 7" (17.8 cm), serrated handle, serrated jaws, dissecting end
- 6-189 CUSHING Tissue Forceps 7" (17.8 cm), serrated handle, 1 x 2 teeth, dissecting end



6-188



6-189

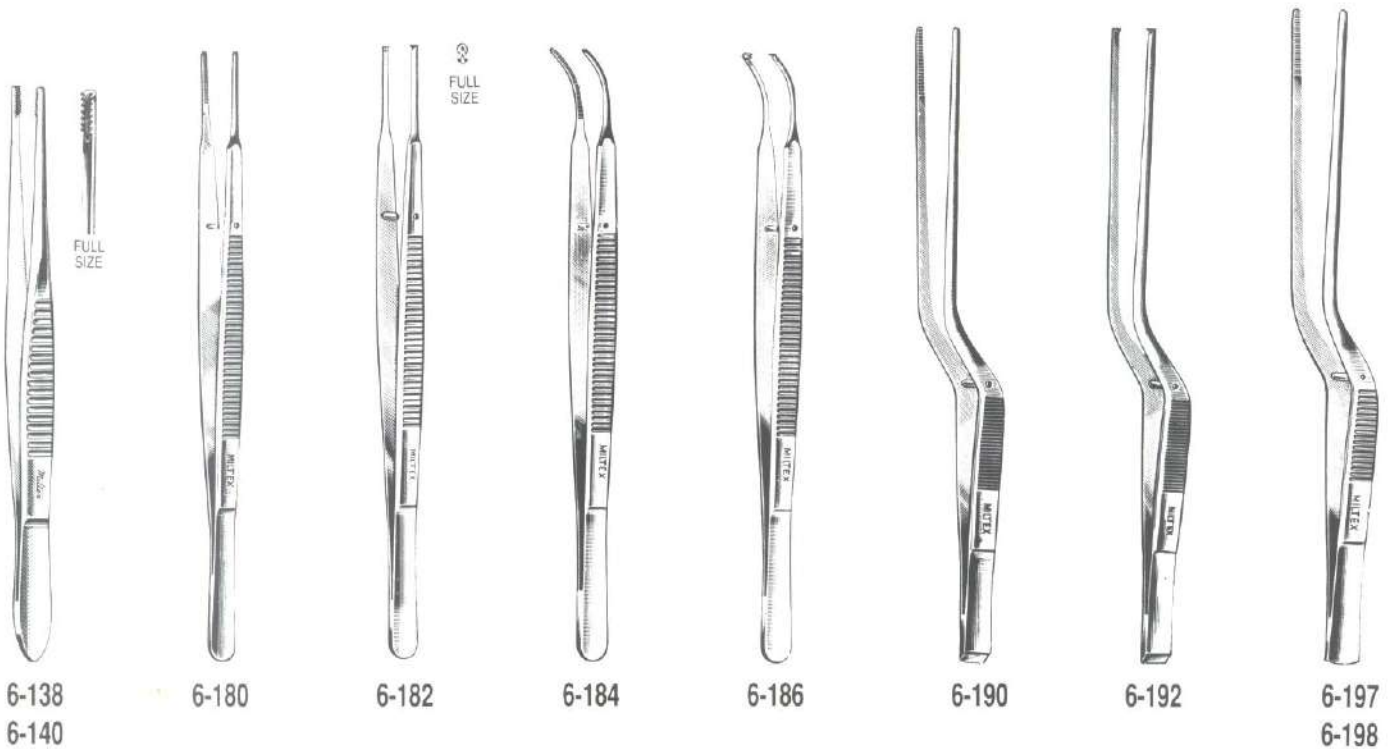

- 6-138 BROWN Tissue Forceps 6" (15.2 cm), double rows of 8 x 8 teeth
- 6-140 BROWN Tissue Forceps 8" (20.3 cm), double rows of 8 x 8 teeth
- 6-180 GERALD Dressing Forceps 7" (17.8 cm), straight, serrated
- 6-182 GERALD Tissue Forceps 7" (17.8 cm), straight, 1 x 2 teeth
- 6-184 GERALD Dressing Forceps 7" (17.8 cm), curved, serrated
- 6-186 GERALD Tissue Forceps 7" (17.8 cm), curved, 1 x 2 teeth
- 6-190 CUSHING Bayonet Dressing Forceps 7¼" (18.4 cm), serrated, scraper end
- 6-192 CUSHING Bayonet Tissue Forceps 7¼" (18.4 cm), 1 x 2 teeth, scraper end
- 6-197 GRUENWALD (JANSEN) Bayonet Dressing Forceps 6½" (16.5 cm), serrated
- 6-198 ADSON Bayonet Dressing Forceps 8¼" (21 cm), serrated
- 26-956 FERRIS SMITH Tissue Forceps 7" (17.8 cm), serrated platform tips with 1 x 2 teeth
- 26-958 FERRIS SMITH Tissue Forceps 7" (17.8 cm), serrated platform tips with 2 x 3 teeth





7-8
7-10

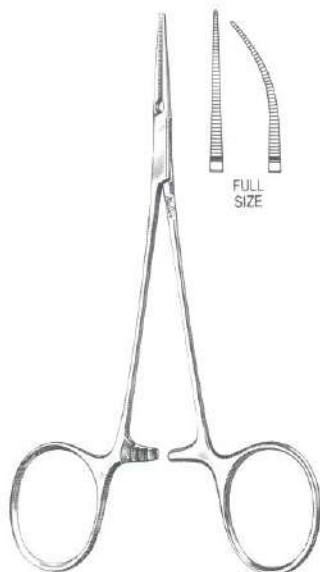

17-2600
17-2602

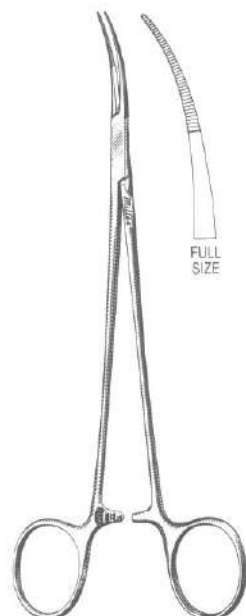

17-2603



7-102

7-8 HALSTED Mosquito Forceps 5" (12.7 cm), straight, extra delicate

7-10 HALSTED Mosquito Forceps 5" (12.7 cm), curved, extra delicate

17-2600 JACOBSON Micro Mosquito Forceps 5" (12.7 cm), straight, extremely delicate

17-2602 JACOBSON Micro Mosquito Forceps 5" (12.7 cm), curved, extremely delicate

17-2603 JACOBSON Hemostatic Forceps 7" (17.8 cm), curved, extremely delicate

7-102 DANDY Scalp Hemostatic Forceps 5½" (14 cm), curved sideways, serrated

7-240 ADSON Hemostatic Forceps 7¼" (18.4 cm), straight

7-242 ADSON Hemostatic Forceps 7¼" (18.4 cm), curved

26-1040 SCHWARTZ Clip Applying Forceps 8" (20.3 cm)

26-1041 SCHWARTZ Vessel Clip 1" (2.5 cm), straight jaws 1.7 x 8 mm

26-1042 SCHWARTZ Vessel Clip 1" (2.5 cm), slightly angled jaws 1.7 x 8 mm

26-1043 SCHWARTZ Vessel Clip 1" (2.5 cm), strong angled jaws 1.7 x 8 mm

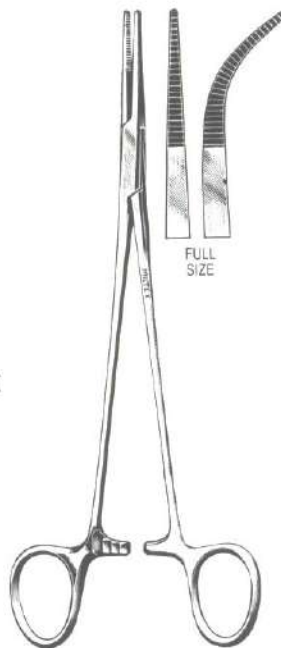

7-240
7-242



26-1040

26-1041 to 26-1043

For Micro Vessel Clips see page 223

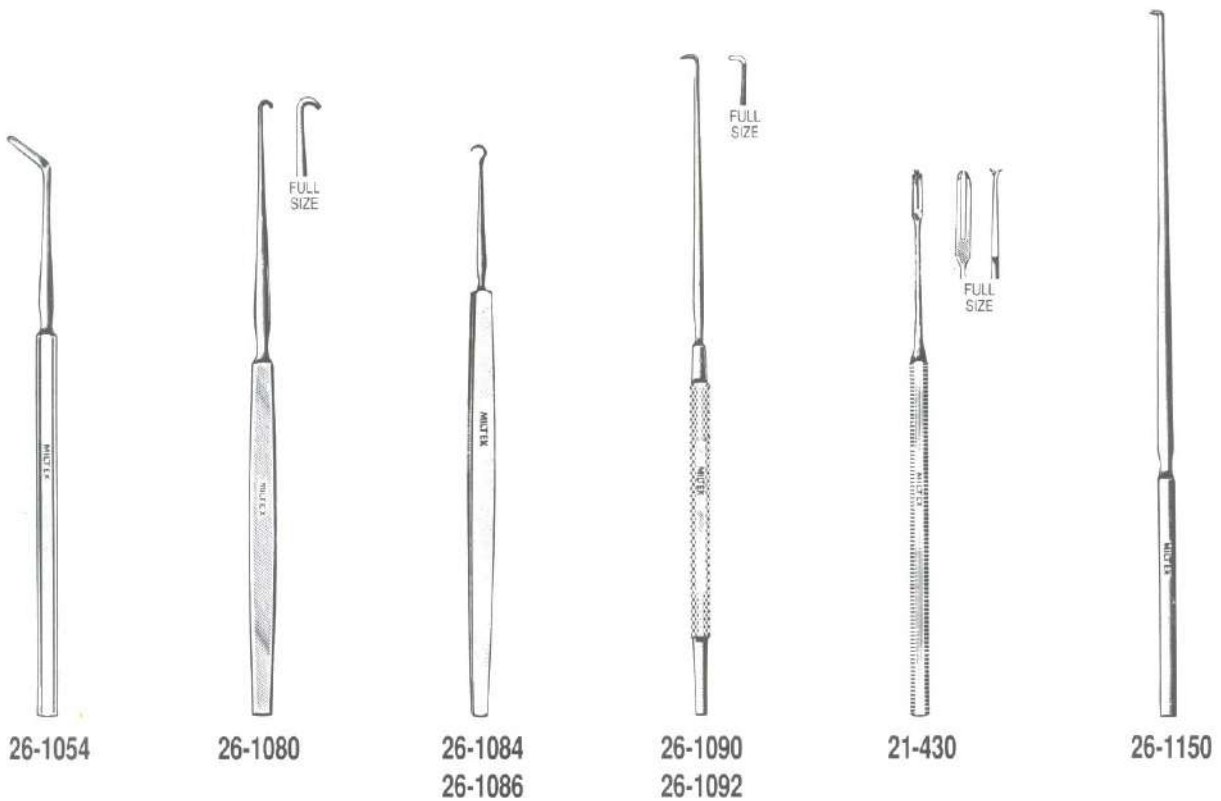

- 26-1054** FRAZIER Dura Separator 6½" (16.5 cm), angled blade ½" (1.3 cm) long, from ⅛" (.32 cm) to ¼" (.16 cm) wide
- 26-1080** CUSHING Dura Hook 6½" (16.5 cm), blunt
- 26-1084** FRAZIER Dura Hook 5" (12.7 cm), sharp point
- 26-1086** FRAZIER Dura Hook 5" (12.7 cm), blunt point
- 26-1090** ADSON Dura and Dissecting Hook 8" (20.3 cm), sharp blade 5 mm at right angle
- 26-1092** ADSON Dura Hook 8" (20.3 cm), blunt 5 mm hook at right angle
- 21-430** MILTEX Tissue Twist Hook 5½" (14 cm)
- 26-1150** DANDY Nerve Hook 9" (22.9 cm), straight

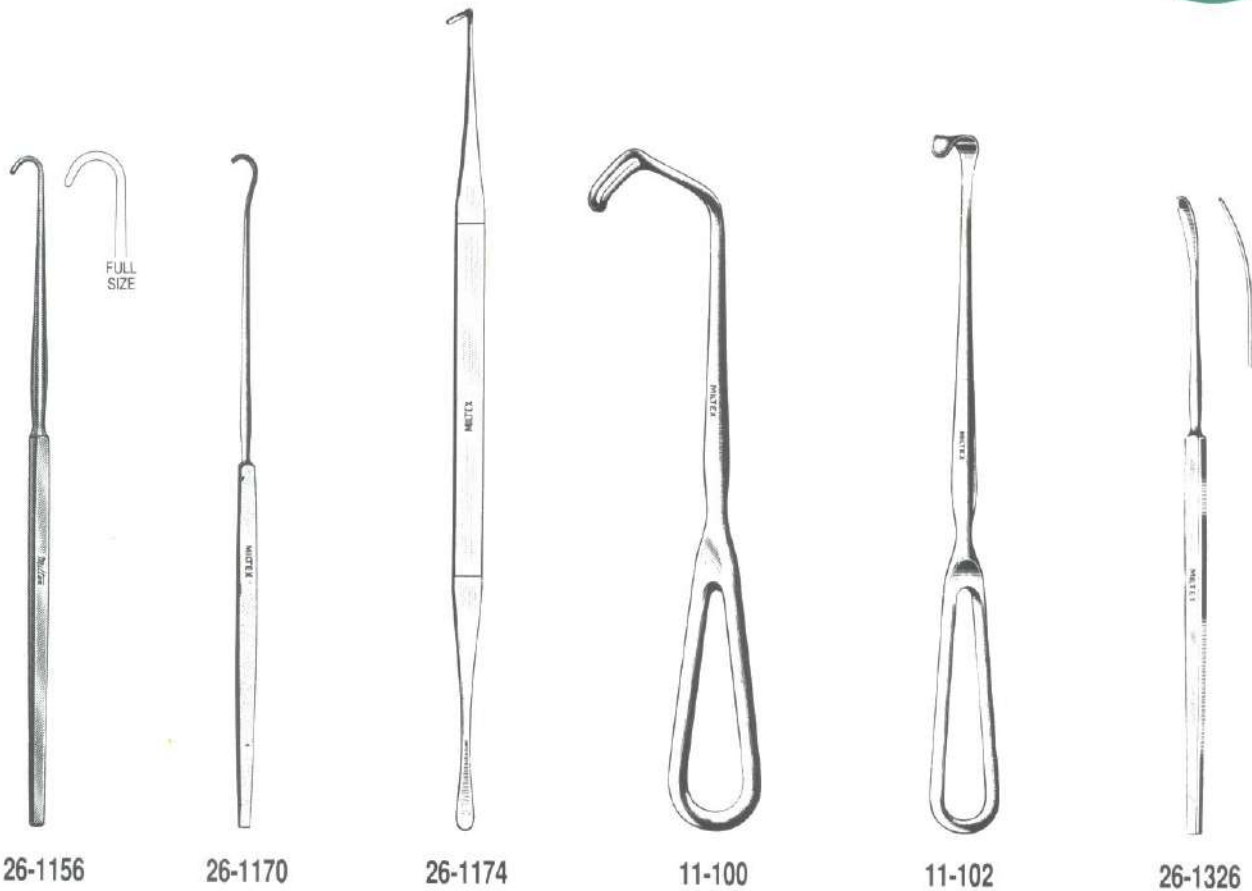

- 26-1156** GRAHAM Nerve Hook 7" (17.8 cm), blunt, 6 mm deep
- 26-1170** SMITHWICK Nerve Hook 7" (17.8 cm), blunt, 10 mm deep
- 26-1174** SMITHWICK Sympathectomy Hook and Dissector 12" (30.5 cm)
- 11-100** CUSHING Decompression Retractor 8½" (21.6 cm), fenestrated blade
- 11-102** CUSHING Vein and Nerve Retractor 9" (22.9 cm), blade 11 x 13 mm
- 26-1326** SACHS Nerve Separator-Spatula 7½" (19.1 cm), blunt blade 3 mm wide, slightly curved

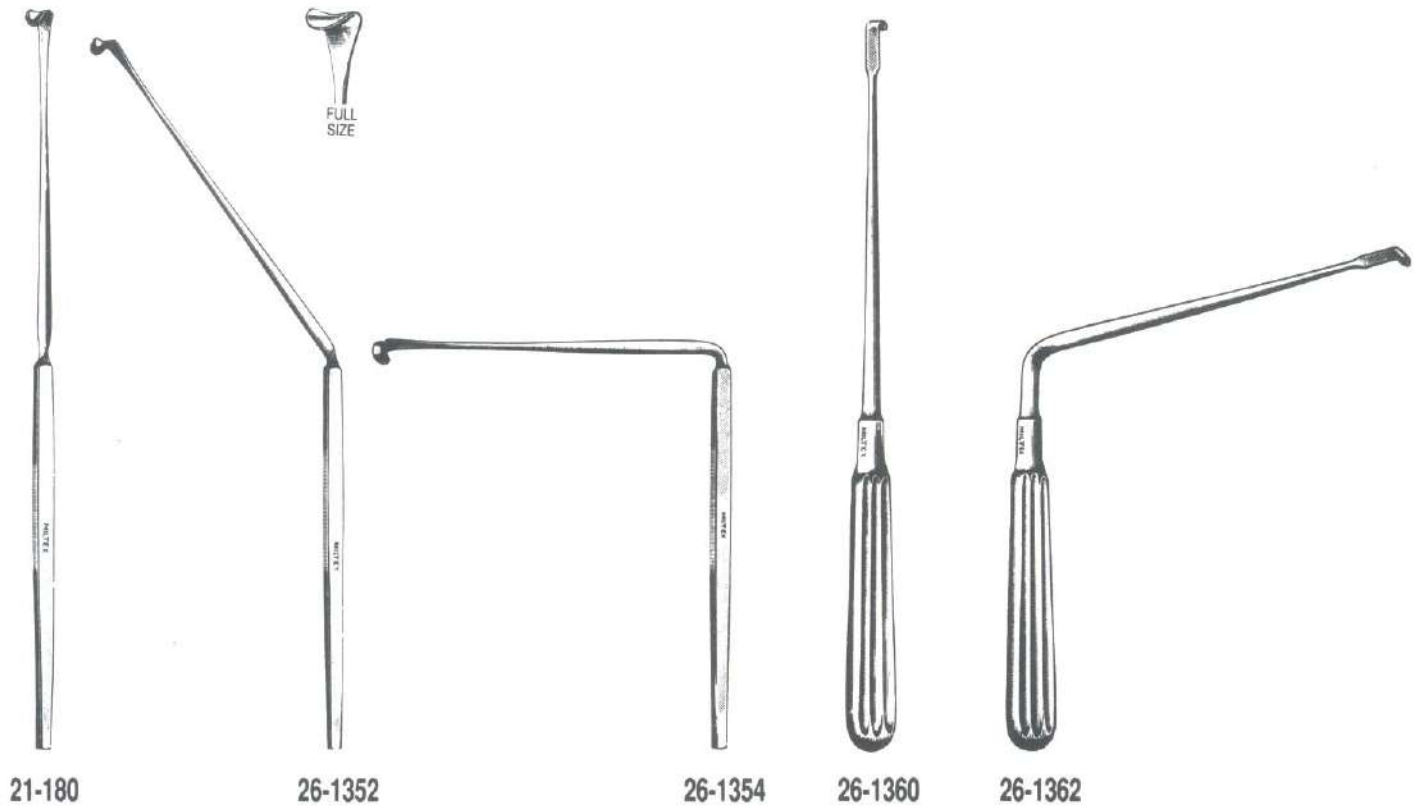

- 21-180 LOVE Nerve Root Retractor 8½" (21.6 cm), straight, 7 mm blade
 26-1352 LOVE Nerve Root Retractor 8½" (21.6 cm), angled 45°, 7 mm blade
 26-1354 LOVE Nerve Root Retractor 8½" (21.6 cm), angled 90°, 7 mm blade
 26-1360 SCOVILLE Nerve Root Retractor 9" (22.9 cm), straight, 8 mm wide blade
 26-1362 SCOVILLE Nerve Root Retractor 9" (22.9 cm), angular, 8 mm wide blade

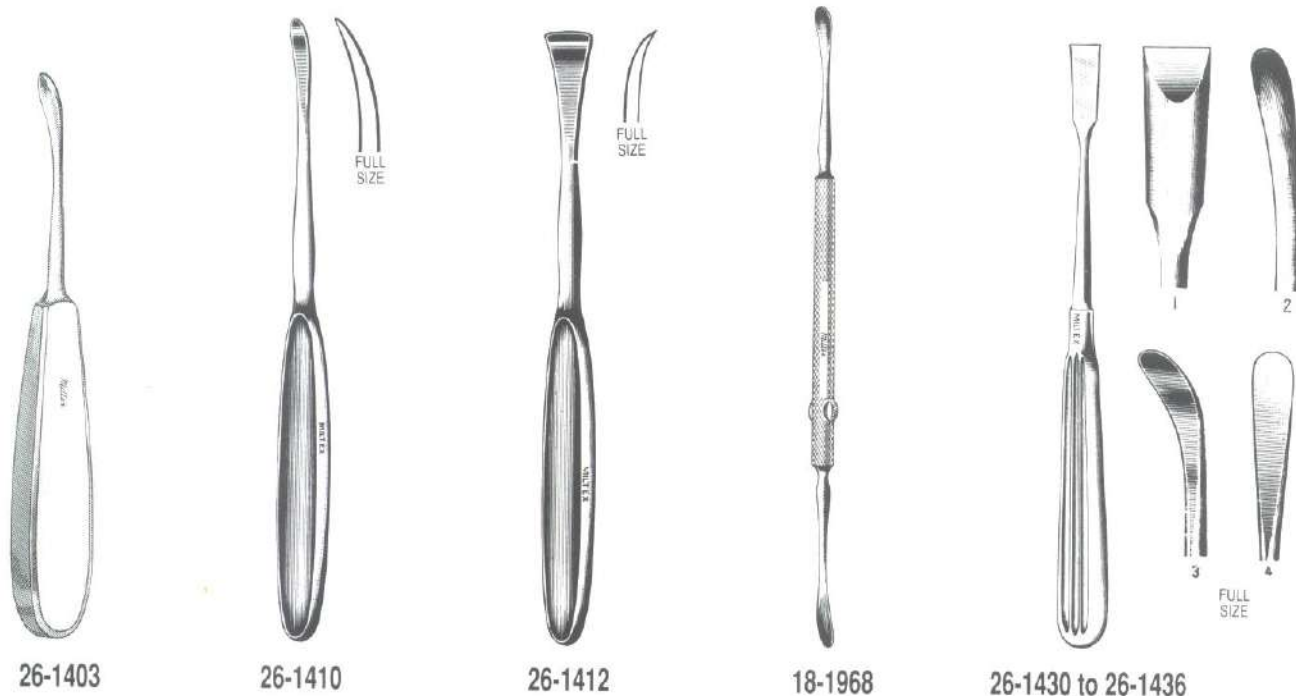

- 26-1403 CUSHING "LITTLE JOKER" Periosteal Elevator 6" (15.2 cm)
- 26-1410 LANGENBECK Periosteal Elevator 7½" (19.1 cm), narrow model, 7 mm wide blunt blade
- 26-1412 LANGENBECK Periosteal Elevator 7½" (19.1 cm), wide model, 17 mm wide sharp blade
- 18-1968 FREER Elevator 7" (17.8 cm), double end sharp and blunt blades 5 mm wide
- 26-1430 ADSON Periosteal Elevator 6½" (16.5 cm), chisel edge, straight, 8 mm wide
- 26-1432 ADSON Periosteal Elevator 6½" (16.5 cm), blunt, curved, 6 mm wide
- 26-1434 ADSON Periosteal Elevator 6½" (16.5 cm), semi-sharp, curved, 7 mm wide
- 26-1436 ADSON Periosteal Elevator 6½" (16.5 cm), semi-sharp, straight, 6 mm wide



26-1450



26-1451



26-1452



26-1453



26-1454

PENFIELD DISSECTORS

26-1450	Style No. 1	7¼" (18.4 cm), double end, 6 mm sharp cup and 6 mm blunt dissector
26-1451	Style No. 2	7¾" (19.7 cm), double end, wax packer and 6 mm blunt dissector, slightly curved
26-1452	Style No. 3	7½" (19.1 cm), double end, wax packer and 6 mm blunt dissector, fully curved
26-1453	Style No. 4	8¾" (22.2 cm), single end, light pattern, 3 mm blunt dissector, slightly curved
26-1454	Style No. 5	11½" (29.2 cm), double end, slightly curved, blunt dissector blades 7 mm and 8 mm wide



26-1620
26-1624



26-1627 to 26-1640

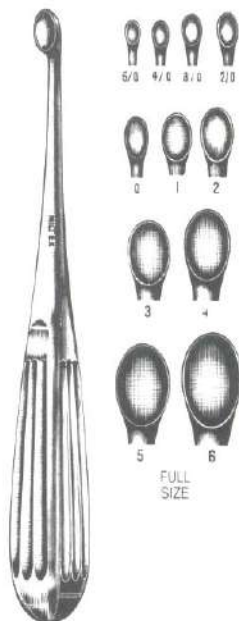

19-700 to 19-720

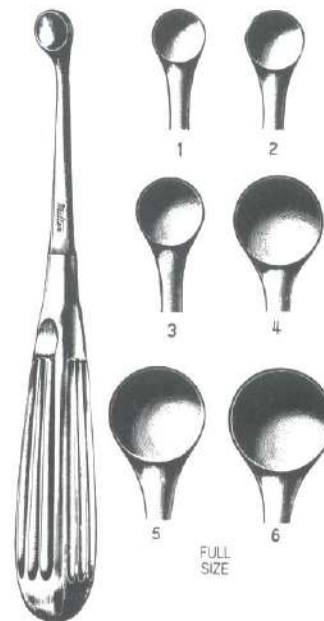

26-1650 to 26-1660

- 26-1620** SCOVILLE Ruptured Disc Curette 10" (25.4 cm), angled up, cup 4 x 10 mm
26-1624 SCOVILLE Ruptured Disc Curette 10" (25.4 cm), angled down, cup 4 x 10 mm

HIBBS SPRATT SPINAL FUSION CURETTES 9" (22.9 cm), Oval Cup

26-1627	Size 3/0	26-1634	Size 3
26-1628	Size 2/0	26-1636	Size 4
26-1629	Size 0	26-1638	Size 5
26-1630	Size 1	26-1640	Size 6
26-1632	Size 2		

SPRATT (BRUN) BONE CURETTES 6½" (16.5 cm), Oval Cups

19-700	Size 5/0	19-712	Size 2
19-702	Size 4/0	19-714	Size 3
19-704	Size 3/0	19-716	Size 4
19-706	Size 2/0	19-718	Size 5
19-708	Size 0	19-720	Size 6
19-710	Size 1		

BRUN BONE CURETTES 6¾" (17.1 cm), Round Cups

26-1650	Size 1	7 mm	26-1656	Size 4	11 mm
26-1652	Size 2	8 mm	26-1658	Size 5	12 mm
26-1654	Size 3	9 mm	26-1660	Size 6	14 mm



11-672

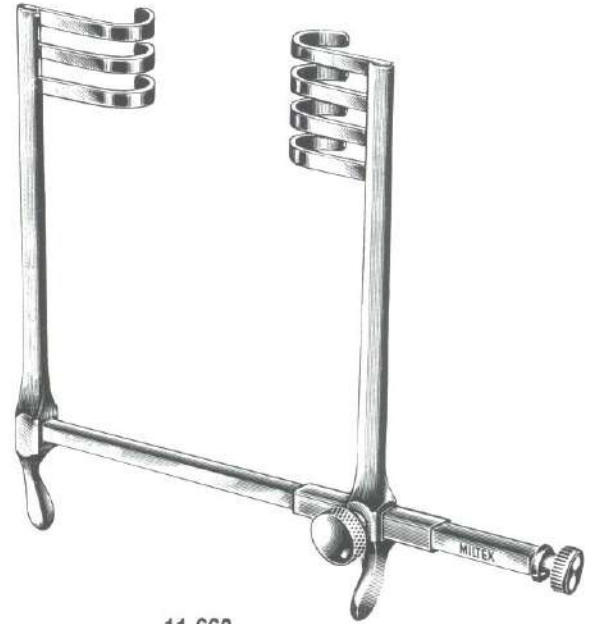

11-660

11-672 BADGLEY Laminectomy Retractor, 6½" (16.5 cm) spread, 4 x 4 blunt teeth 2" (5.1 cm) x 1¾" (4.4 cm)

11-660 FRAZIER Laminectomy Retractor, 3¼" (8.3 cm) spread, 3 x 4 blunt teeth

11-676 TUFFIER Retractor, 6½" (16.5 cm) spread, 2" (5.1 cm) x 1¾" (4.4 cm) grooved blades



11-676



11-240 to 11-244



11-642-SH
11-642-BL

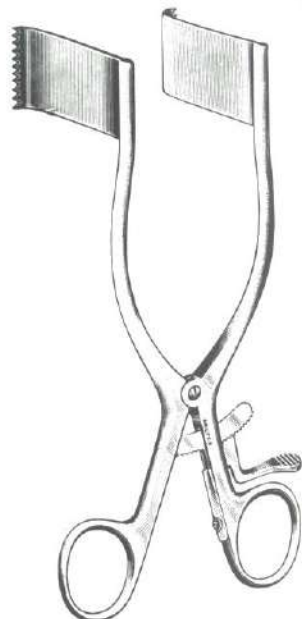

11-650 to 11-656



11-684
11-686



- 11-240 MEYERDING Laminectomy Retractor 9½" (24.1 cm), large blade 3½" (8.9 cm) x 2" (5.1 cm)
- 11-242 MEYERDING Laminectomy Retractor 9½" (24.1 cm), medium blade 3" (7.6 cm) x 1" (2.5 cm)
- 11-244 MEYERDING Laminectomy Retractor 9½" (24.1 cm), small blade 2" (5.1 cm) x ¾" (1.6 cm)
- 11-642-SH BECKMAN-WEITLANER Retractor, hinged, 9" (22.9 cm), sharp 3 x 4 teeth
- 11-642-BL BECKMAN-WEITLANER Retractor, hinged, 9" (22.9 cm), blunt 3 x 4 teeth
- MEYERDING SELF-RETAINING LAMINECTOMY RETRACTORS, ¾" (9.5 cm) spread
 - 11-650 1" (2.5 cm) x 2⅝" (6.1 cm) blades
 - 11-652 1" (2.5 cm) x 2⅛" (5.4 cm) blades
 - 11-654 1" (2.5 cm) x 1¾" (4.4 cm) blades
 - 11-656 ¾" (1.9 cm) x 2⅝" (6.1 cm) blades
- 11-684 BECKMAN-ADSON Laminectomy Retractor 12½" (31.8 cm), hinged, sharp 4 x 4 teeth 1" (2.5 cm) wide x ¾" (1.9 cm) deep
- 11-686 BECKMAN-ADSON Laminectomy Retractor 12½" (31.8 cm), hinged, sharp 4 x 4 teeth 1¼" (3.2 cm) wide x 1¾" (4.4 cm) deep



26-1973

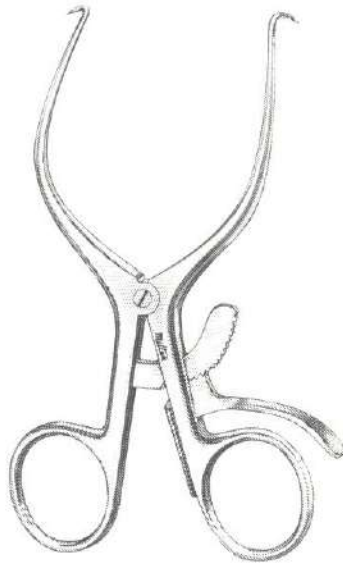

11-365
11-366



26-2001

26-2000
26-2005

- 26-1973** BECKMAN-EATON Laminectomy Retractor 12 $\frac{3}{4}$ " (32.4 cm), hinged, sharp
7 x 7 teeth 1 $\frac{3}{4}$ " (4.4 cm) wide x 2" (5.1 cm) deep
- 11-365** Pediatric GELPI Retractor 5 $\frac{1}{2}$ " (14 cm), with grip lock
11-366 GELPI Retractor 6 $\frac{3}{4}$ " (17.1 cm), with grip lock
- 26-2000** INGE Lamina Spreader 6" (15.2 cm), jaws open to 1 $\frac{1}{8}$ " (2.8 cm)
26-2001 INGE Lamina Spreader 6" (15.2 cm), jaws open to 1 $\frac{1}{8}$ " (2.8 cm), without teeth
26-2005 INGE Lamina Spreader 9 $\frac{1}{2}$ " (24.1 cm), jaws open to 1 $\frac{3}{4}$ " (4.4 cm)



27-2
27-6



27-4
27-7



27-20
27-22



27-21
27-23

- 27-2 KERN Bone Holding Forceps 9½" (24.1 cm), standard size, plain
- 27-4 KERN Bone Holding Forceps 9½" (24.1 cm), standard size, with ratchet
- 27-6 KERN Bone Holding Forceps 6" (15.2 cm), pediatric size, plain
- 27-7 KERN Bone Holding Forceps 6" (15.2 cm), pediatric size, with ratchet

- 27-20 LANE Bone Holding Forceps 13" (33 cm), plain
- 27-21 LANE Bone Holding Forceps 13" (33 cm), with ratchet
- 27-22 LANE Bone Holding Forceps 17" (43.2 cm), plain
- 27-23 LANE Bone Holding Forceps 17" (43.2 cm), with ratchet



27-11 to 27-13

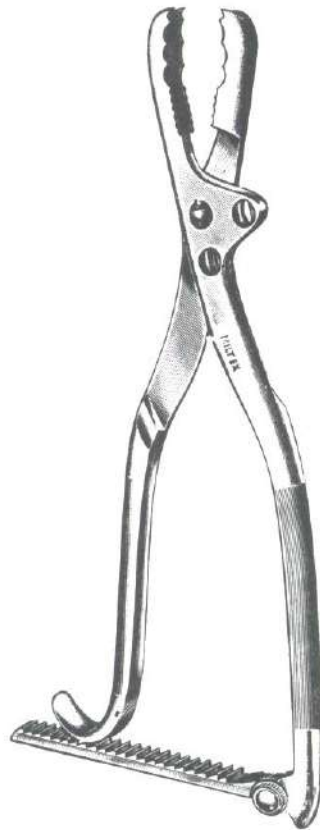

27-14

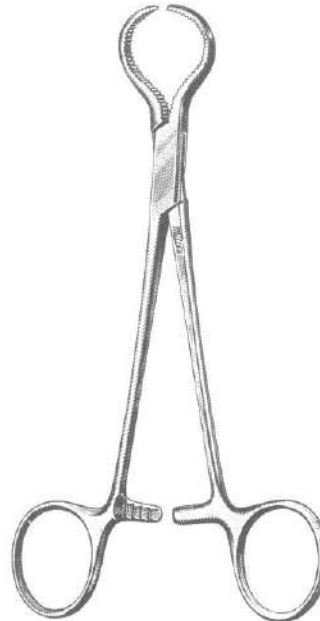

27-16

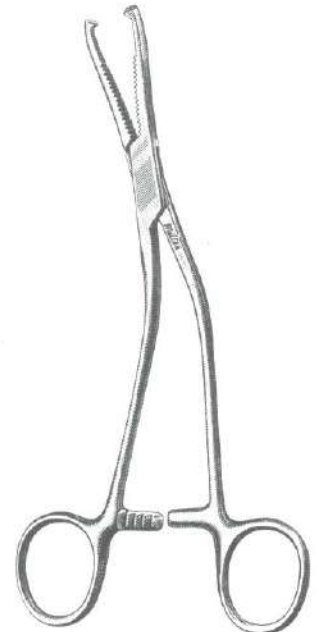

27-24

- 27-11 LAMBOTTE Bone Holding Forceps, 8 $\frac{3}{4}$ " (22.2 cm), self-adjusting jaws
- 27-12 LAMBOTTE Bone Holding Forceps, 10 $\frac{3}{4}$ " (27.3 cm), self-adjusting jaws
- 27-13 LAMBOTTE Bone Holding Forceps, 12 $\frac{1}{4}$ " (31.1 cm), self-adjusting jaws
- 27-14 FARABEU-F-LAMBOTTE Bone Holding Forceps, 10 $\frac{1}{4}$ " (26 cm)
- 27-16 LEWIN Bone Holding Forceps 7" (17.8 cm), serrated jaws
- 27-24 DINGMAN Small Bone and Cartilage Clamp 7 $\frac{1}{2}$ " (19.1 cm), serrated jaws, 2 x 2 teeth, 4 mm wide



27-30 to 27-34

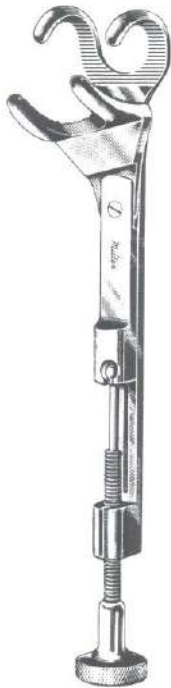

27-42
27-44

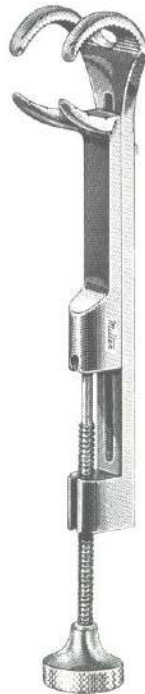

27-46
27-47



27-60

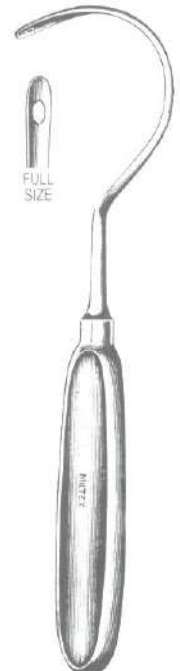

27-110

- 27-30 LOWMAN Bone Clamp 5" (12.7 cm), calibrated in $\frac{1}{8}$ " (.32 cm), 1 x 2 prong jaws $\frac{3}{4}$ " (1.9 cm) wide
- 27-32 LOWMAN Bone Clamp 7" (17.8 cm), calibrated in $\frac{1}{8}$ " (.32 cm), 1 x 2 prong jaws 1" (2.5 cm) wide
- 27-34 LOWMAN Bone Clamp 8" (20.3 cm), calibrated in $\frac{1}{8}$ " (.32 cm), 1 x 2 prong jaws $1\frac{1}{4}$ " (3.2 cm) wide
- 27-42 LOWMAN-HOGLUND Bone Clamp 7" (17.8 cm), calibrated in $\frac{1}{8}$ " (.32 cm), 2 x 2 prong swivel jaws 1" (2.5 cm) wide
- 27-44 LOWMAN-HOGLUND Bone Clamp 8" (20.3 cm), calibrated in $\frac{1}{8}$ " (.32 cm), 2 x 2 prong swivel jaws $1\frac{3}{8}$ " (3.5 cm) wide
- 27-46 LAMBERT-LOWMAN Bone Clamp 7" (17.8 cm), 2 x 2 prong jaws 1" (2.5 cm) wide
- 27-47 LAMBERT-LOWMAN Bone Clamp 8" (20.3 cm), 2 x 2 prong jaws $1\frac{3}{8}$ " (3.5 cm) wide
- 27-60 VAN BUREN Sequestrum Forceps 9" (22.9 cm), serrated jaws angled on side
- 27-110 Bone Wire Guide $8\frac{3}{4}$ " (22.2 cm), U.S. Pattern
- 27-144 POLK Finger Goniometer 6" (15.2 cm), graduated in inches and centimeters

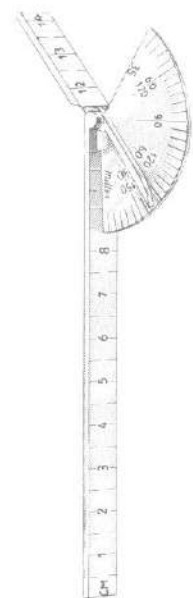

27-144

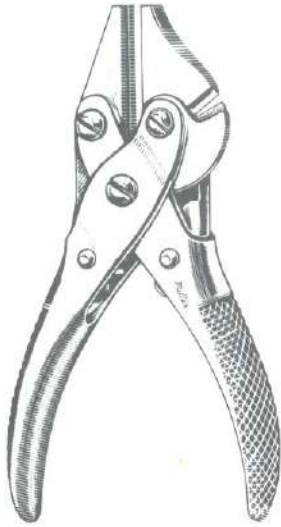

9-128



22-500TC
22-502TC

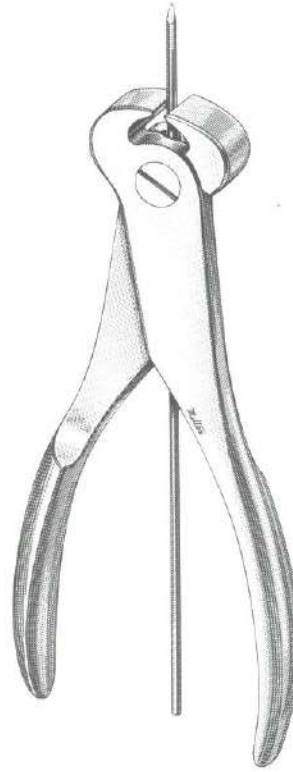

27-158

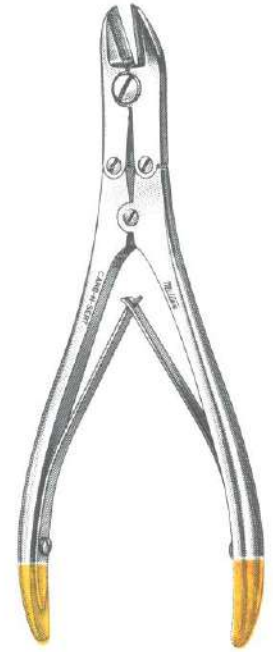

27-159TC

- 9-128** Double Action Parallel Pliers and Wire Cutter 4½" (11.4 cm), nickel plated
- 22-500TC** Wire Twister 6" (15.2 cm), with Carb-N-Sert jaws
- 22-502TC** Wire Twister 8" (20.3 cm), with Carb-N-Sert jaws
- 27-158** MILTEX Cannulated Pin and Wire Cutter 7½" (19.1 cm), end cutting up to 3.2 mm (1/8") soft wire or 1.6 mm (1/16") hard wire
- 27-159TC** C-N-S Pin and Wire Cutter 7" (17.8 cm), double action, CARB-N-SERT cutting blades, cuts up to 2 mm (5/64") soft wire or 1.6 mm (1/16") hard wire
- 27-160** DIAMOND Pin and Wire Cutter 6½" (16.5 cm), cuts up to 2 mm (5/64") diameter hard wire, stainless



27-160



27-161TC

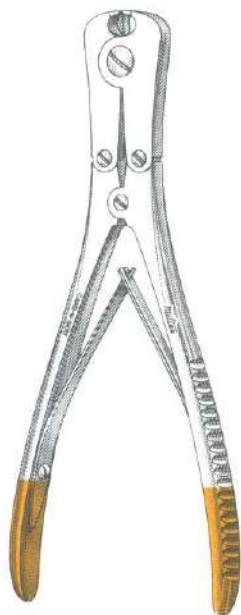

27-163TC

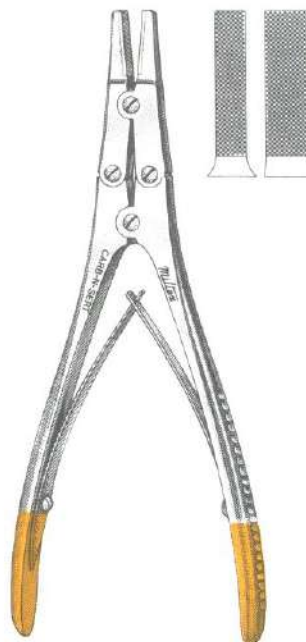

27-164TC
27-165TC



27-176TC

- 27-161TC** MILTEX Double Action Pin Cutter 15" (38.1 cm), heavy duty, with CARB-N-SERT cutting blades, will cut up to 4.8 mm ($\frac{3}{16}$ ") diameter, stainless
- 27-163TC** C-N-S Front and Side Pin and Wire Cutter 7" (17.8 cm), Double Action Flush Cutting CARB-N-SERT Blades cuts up to 2 mm ($\frac{5}{64}$ ") soft wire or 1.6 mm ($\frac{1}{16}$ ") hard wire
- 27-164TC** C-N-S Pin & Wire Puller 7" (17.8 cm), double action, with CARB-N-SERT 4 mm wide jaws
- 27-165TC** C-N-S Pin & Wire Puller 7" (17.8 cm), double action, with CARB-N-SERT 6 mm wide jaws
- 27-176TC** MILTEX Pin Puller 5½" (14 cm) CARB-N-SERT serrated top jaw measures 1 cm in length. Grooved cross-serrated opposing jaw. (Groove measures 1 cm in length.)

For Orthopedic Suture Wire & Wire Cutting Scissors – see pages 135 & 141.

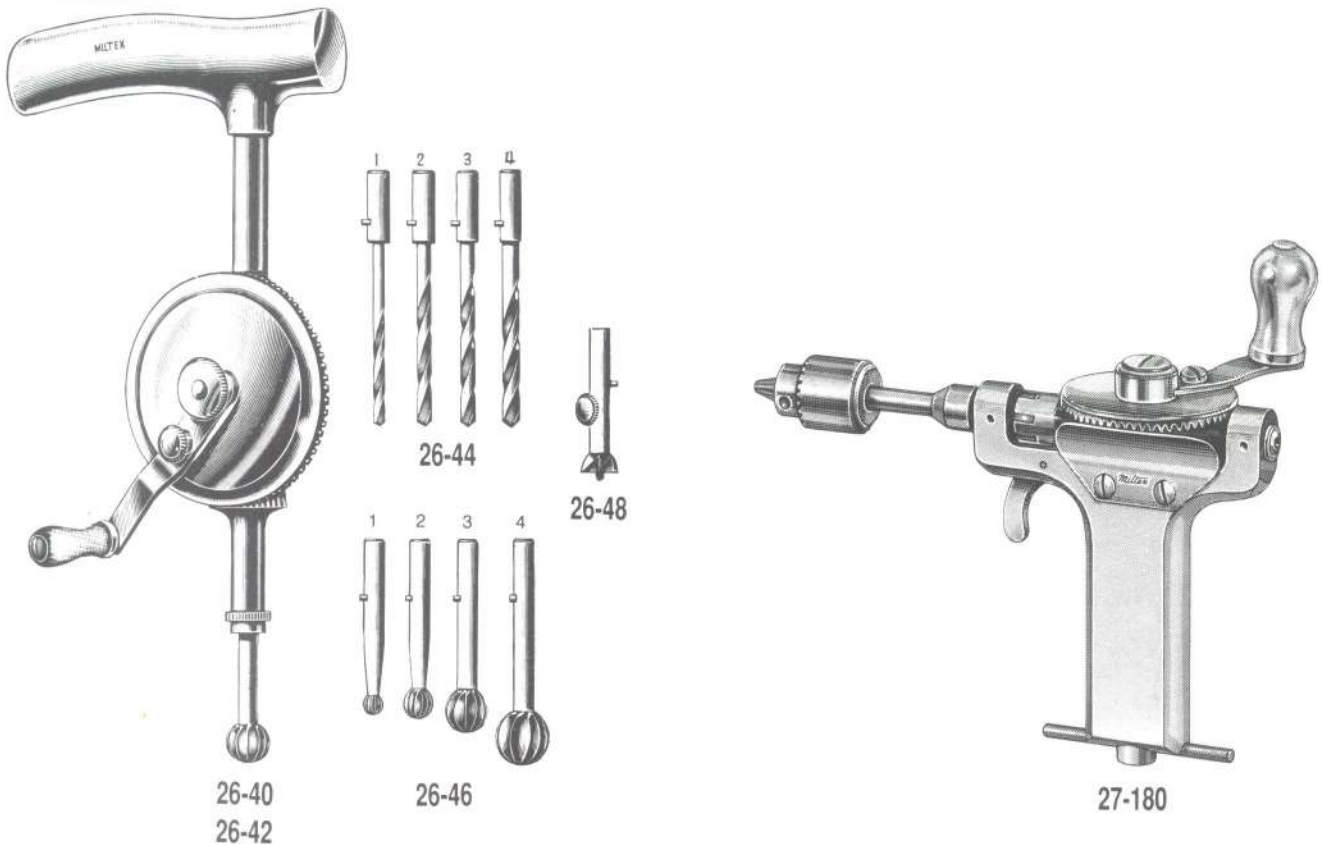

26-40 STILLE Pattern Drill Set, complete with 4 twist drills (2.5 to 4 mm), 4 burs (4 to 16 mm) and 1 trephine (10 mm). Chrome plated drill, stainless points

26-42 STILLE Pattern Drill, chrome plated

Replacement Points for Stille Pattern Drill

Twist Drills		Round Burs	
26-44-1	2.5 mm	26-46-1	4 mm
26-44-2	3 mm	26-46-2	8 mm
26-44-3	3.5 mm	26-46-3	11 mm
26-44-4	4 mm	26-46-4	16 mm
26-48	Trepine 10 mm dia.		

27-180 BUNNELL Hand Drill, Lightweight, chrome plated, with $\frac{5}{32}$ " (4 mm) capacity stainless Jacobs chuck. Cannulated for use with Kirschner wires and thin drills. Chuck key stores in handle.

KIRSCHNER WIRES 12" (30.5 cm), Trocar Point with Flat Chuck End

27-202	.035" (0.9 mm) diameter
27-204	.045" (1.1 mm) diameter
27-206	.0625" (1.6 mm) diameter

KIRSCHNER WIRES 7 $\frac{1}{2}$ " (19.1 cm), Trocar Points at both ends

27-208	.035" (0.9 mm) diameter
27-210	.045" (1.1 mm) diameter
27-212	.0625" (1.6 mm) diameter





27-213
27-214



27-215 to 27-218

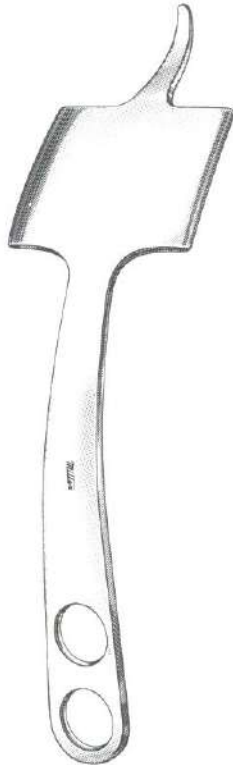

27-219



11-580
11-582



27-223

- 27-213 MINI-HOHMANN Retractor 6¼" (15.9 cm), blade 6 mm wide
- 27-214 MINI-HOHMANN Retractor 6¼" (15.9 cm), blade 8 mm wide
- 27-215 HOHMANN Retractor 9¼" (23.5 cm), blade 10 mm wide
- 27-216 HOHMANN Retractor 9¼" (23.5 cm), blade 18 mm wide
- 27-217 HOHMANN Retractor 9¼" (23.5 cm), blade 25 mm wide
- 27-218 HOHMANN Retractor 9¼" (23.5 cm), blade 43 mm wide
- 27-219 HOHMANN Retractor 9¾" (24.8 cm), blade 70 mm wide
- 11-580 BENNETT Bone Elevator and Retractor 9½" (24.1 cm), small blade 1¾" (4.4 cm) wide
- 11-582 BENNETT Bone Elevator and Retractor 9¾" (24.8 cm), large blade 2½" (6.4 cm) wide
- 27-223 BLOUNT Knee Retractor 7" (17.8 cm), blade 1¾" (4.4 cm) deep, ⅝" (1.6 cm) wide tapering to ⅜" (.48 cm)
- 27-224 SMILLIE Meniscus Hook Retractor 5¾" (14.6 cm), blade ¾" (1.9 cm) x 1⅜" (3.5 cm)

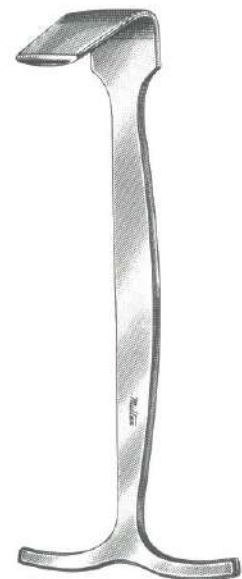

27-224

For additional Retractors see pages 151 - 187

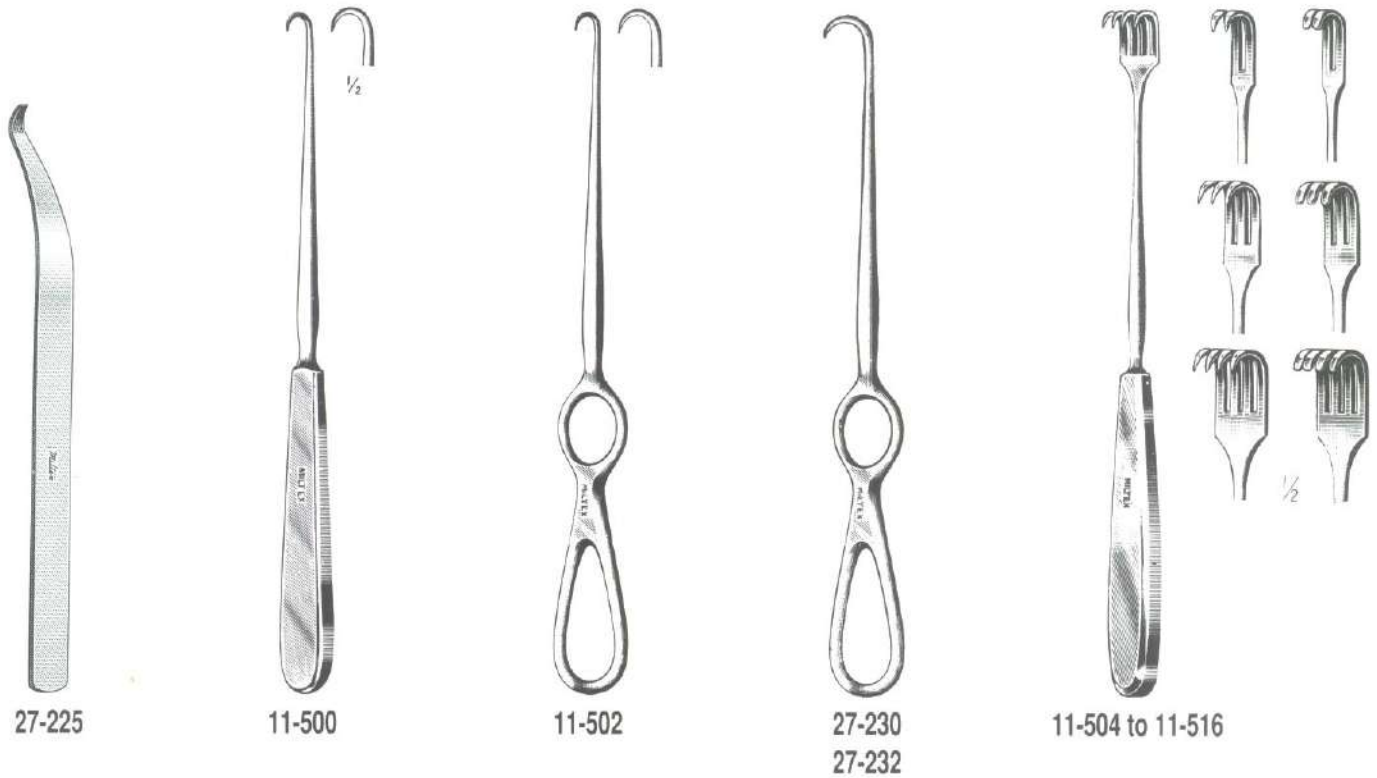

- 27-225** HAYS Hand and Finger Retractor 6" (15.2 cm), angled blade 1½" (3.8 cm) long, ⅜" (1 cm) wide tapering to ⅛" (.32 cm)
- 11-500** VOLKMAN Hook 8½" (21.6 cm), sharp, hollow handle
- 11-502** VOLKMAN Hook 8½" (21.6 cm), sharp, ring handle
- 27-230** VOLKMAN Hook Retractor 9" (22.9 cm), sharp point 15 mm deep
- 27-232** VOLKMAN Hook Retractor 9" (22.9 cm), blunt tip 15 mm deep

VOLKMAN RETRACTORS 8½" (21.6 cm), hollow handle

	Sharp	Blunt
11-504	2 prongs	11-512
11-506	3 prongs	11-514
11-508	4 prongs	11-516

For additional Retractors see pages 151 - 187

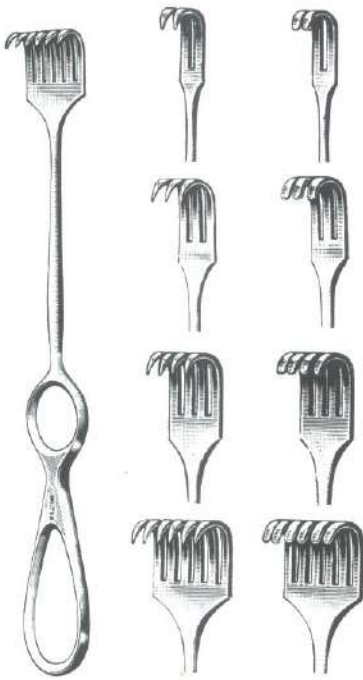

11-530 to 11-544

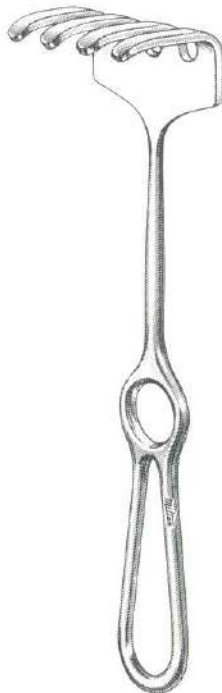

11-349



11-350
11-352

VOLKMAN RETRACTORS 8" (20.3 cm), Ring Handle

	Sharp	Blunt
11-530	2 prongs	11-538
11-532	3 prongs	11-540
11-534	4 prongs	11-542
11-536	6 prongs	11-544

11-349 OLLIER Rake Retractor 8½" (21.6 cm), blunt, 4 prongs
2¼" (5.7 cm) x 1¾" (4.4 cm)

11-350 ISRAEL Rake Retractor 9" (22.9 cm), blunt, 4 prongs
1½" (3.8 cm) x 1⅝" (4.1 cm)

11-352 ISRAEL Rake Retractor 9" (22.9 cm), blunt, 6 prongs
2¼" (5.7 cm) x 1¾" (4.4 cm)

For additional Retractors see pages 151 - 187



27-260 to 27-264



27-270 to 27-274



27-280
27-282



19-750 to 19-760



19-770 to 19-780

- | | |
|--------|---|
| 27-260 | U.S. ARMY Pattern Chisel 6½" (16.5 cm), 6 mm wide |
| 27-262 | U.S. ARMY Pattern Chisel 6½" (16.5 cm), 12 mm wide |
| 27-264 | U.S. ARMY Pattern Chisel 6½" (16.5 cm), 18 mm wide |
| 27-270 | U.S. ARMY Pattern Osteotome 6½" (16.5 cm), 6 mm wide |
| 27-272 | U.S. ARMY Pattern Osteotome 6½" (16.5 cm), 12 mm wide |
| 27-274 | U.S. ARMY Pattern Osteotome 6½" (16.5 cm), 18 mm wide |
| 27-280 | U.S. ARMY Pattern Gouge 6½" (16.5 cm), 6 mm wide |
| 27-282 | U.S. ARMY Pattern Gouge 6½" (16.5 cm), 12 mm wide |
| 19-750 | ALEXANDER Chisel 7" (17.8 cm), 4 mm wide |
| 19-752 | ALEXANDER Chisel 7" (17.8 cm), 6 mm wide |
| 19-754 | ALEXANDER Chisel 7" (17.8 cm), 8 mm wide |
| 19-756 | ALEXANDER Chisel 7" (17.8 cm), 10 mm wide |
| 19-758 | ALEXANDER Chisel 7" (17.8 cm), 12 mm wide |
| 19-760 | ALEXANDER Chisel 7" (17.8 cm), 14 mm wide |
| 19-770 | ALEXANDER Gouge 7" (17.8 cm), 4 mm wide |
| 19-772 | ALEXANDER Gouge 7" (17.8 cm), 6 mm wide |
| 19-774 | ALEXANDER Gouge 7" (17.8 cm), 8 mm wide |
| 19-776 | ALEXANDER Gouge 7" (17.8 cm), 10 mm wide |
| 19-778 | ALEXANDER Gouge 7" (17.8 cm), 12 mm wide |
| 19-780 | ALEXANDER Gouge 7" (17.8 cm), 14 mm wide |



27-458 to 27-468



27-458C to 27-466C



27-488 to 27-508



27-510 to 27-522



27-530 to 27-542



HIBBS GOUGES 9" (22.9 cm)

Straight	Size	Curved
27-458	1/4" (.64 cm)	27-458C
27-460	3/8" (.95 cm)	27-460C
27-462	1/2" (1.3 cm)	27-462C
—	5/8" (1.6 cm)	27-464C
27-466	3/4" (1.9 cm)	27-466C
27-468	1" (2.5 cm)	—

LAMBOTTE OSTEOTOMES 9" (22.9 cm)

Straight	Width	Curved
27-488	6 mm (1/4")	27-499
27-490	13 mm (1/2")	27-500
27-492	19 mm (3/4")	27-502
27-494	25 mm (1")	27-504
27-496	32 mm (1 1/4")	27-506
27-498	38 mm (1 1/2")	27-508

SMITH-PETERSEN OSTEOTOMES 8" (20.3 cm)

Straight	Width	Curved
27-510	1/4" (.64 cm)	27-530
27-512	3/8" (.95 cm)	27-532
27-514	1/2" (1.3 cm)	27-534
27-516	5/8" (1.6 cm)	27-536
27-518	3/4" (1.9 cm)	27-538
27-520	1" (2.5 cm)	27-540
27-522	1 1/4" (3.2 cm)	27-542



27-549 to 27-558



27-599 to 27-605



27-609
27-610

SMITH-PETERSEN GOUGES 8" (20.3 cm)

Straight	Width
27-549	1/4" (.64 cm)
27-550	3/8" (.95 cm)
27-551	1/2" (1.3 cm)
27-553	5/8" (1.6 cm)
27-554	3/4" (1.9 cm)
27-556	1" (2.5 cm)
27-558	1 1/4" (3.2 cm)

SWISS PATTERN OSTEOTOMES 5" (12.7 cm)

	Width		Width
27-599	2 mm	26-602A	12 mm
27-600	4 mm	27-603	14 mm
27-601	6 mm	27-604	18 mm
27-601A	8 mm	27-605	20 mm
27-602	10 mm		

27-609 Sterilizer – Storage Case 5 1/2" (14 cm) x 6 1/2" (16.5 cm) x 1/2" (1.3 cm), fitted to hold 9 Swiss Pattern Osteotomes 2 mm to 20 mm

27-610 Set of 9 Swiss Pattern Osteotomes 2 mm to 20 mm, complete in fitted Sterilizer Case



27-680



27-700



27-702



27-703



26-1410



26-1412

- 27-680** MURPHY-LANE Bone Skid 12" (30.5 cm)
- 27-700** PUTTI Bone Rasp 10½" (26.7 cm), flat ends, one side curved on flat, other side curved sideways
- 27-702** PUTTI Bone Rasp 12" (30.5 cm), round and half-round tapered curved ends
- 27-703** Bone File 9¾" (24.8 cm), bayonet shank, half-round blade 3½" (8.9 cm) x ½" (1.3 cm)
- 26-1410** LANGENBECK Periosteal Elevator 7½" (19.1 cm), narrow model, 7 mm wide blunt blade
- 26-1412** LANGENBECK Periosteal Elevator 7½" (19.1 cm), wide model, 17 mm wide sharp blade
- 25-28** SEDILLOT Periosteal Elevator 7½" (19.1 cm), blade 17 mm wide



25-28



27-744
27-746



27-747 to 27-750



27-752



27-753



27-754



27-820 to 27-826

- 27-744** SAYRE Periosteal Elevator 6¾" (17.1 cm), one straight blunt and one curved sharp end
27-746 SAYRE Periosteal Elevator 6¾" (17.1 cm), one straight blunt and one curved blunt end
- 27-747** CHANDLER Elevator 7½" (19.1 cm), blade ½" (1.3 cm) tapering to ¼" (.79 cm)
27-748 CHANDLER Elevator 8" (20.3 cm), blade ¾" (1.9 cm) tapering to ½" (1.3 cm)
27-749 CHANDLER Elevator 9¼" (23.5 cm), blade 1" (2.5 cm) tapering to ⅞" (1.7 cm)
27-750 CHANDLER Elevator 10" (25.4 cm), blade 1¼" (3.2 cm) tapering to ¾" (1.9 cm)
- 27-752** CREGO Periosteal Elevator 8" (20.3 cm), slightly curved blade 7 mm
27-753 CREGO Periosteal Elevator 8" (20.3 cm), fully curved blade 7 mm
27-754 CREGO Periosteal Elevator 8" (20.3 cm), fully curved blade 14 mm
- 27-820** KEY Periosteal Elevator 7" (17.8 cm), ¼" (.64 cm) wide
27-821 KEY Periosteal Elevator 7½" (19.1 cm), ⅜" (.95 cm) wide
27-822 KEY Periosteal Elevator 7½" (19.1 cm), ½" (1.3 cm) wide
27-824 KEY Periosteal Elevator 8" (20.3 cm), ¾" (1.9 cm) wide
27-826 KEY Periosteal Elevator 8¼" (21 cm), 1" (2.5 cm) wide

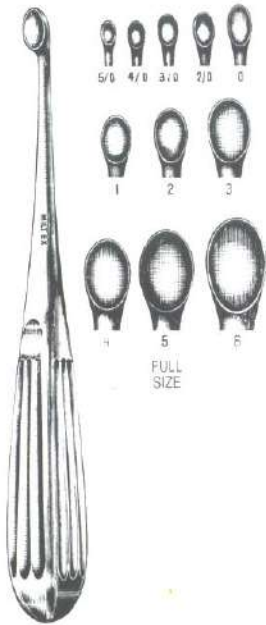

19-700 to 19-720



26-1627 to 26-1640



27-920

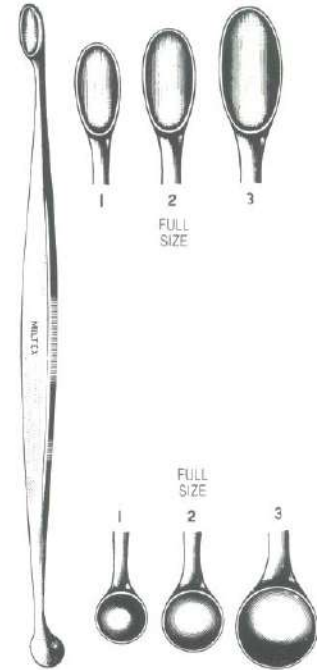

27-924
27-926
27-928

SPRATT (BRUN) BONE CURETTES, Oval Cups

6½" (16.5 cm) Long		9" Long (22.9 cm)	
19-700	Size 5/0	26-1627	Size 3/0
19-702	Size 4/0	26-1628	Size 2/0
19-704	Size 3/0	26-1629	Size 0
19-706	Size 2/0	26-1630	Size 1
19-708	Size 0	26-1632	Size 2
19-710	Size 1	26-1634	Size 3
19-712	Size 2	26-1636	Size 4
19-714	Size 3	26-1638	Size 5
19-716	Size 4	26-1640	Size 6
19-718	Size 5		
19-720	Size 6		

VOLKMAN DOUBLE END CURETTES

27-920	5½" (14 cm) long, oval cups 5 x 10 mm and 6 x 20 mm
27-924	5" (12.7 cm) long, oval cup 6 x 10 mm and round cup 7 mm dia.
27-926	6½" (16.5 cm) long, oval cup 8 x 14 mm and round cup 10 mm dia.
27-928	8" (20.3 cm) long, oval cup 9 x 18 mm and round cup 11 mm dia.



21-321



21-322



27-970



27-972
27-974



27-980

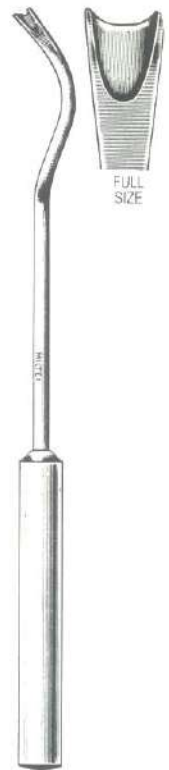

27-984

- 21-321 MARTINI Bone Curette 5½" (14 cm), double end, 4 mm and 5 mm round cups
- 21-322 WILLIGER Bone Curette 5½" (14 cm), double end, 3 mm and 4 mm oval cups
- 27-970 SMILLIE Meniscus Knife 7¼" (18.4 cm), straight chisel blade
- 27-972 SMILLIE Meniscus Knife 7" (17.8 cm), curved left
- 27-974 SMILLIE Meniscus Knife 7" (17.8 cm), curved right
- 27-980 LOWE-BRECK Cartilage Knife 10½" (26.7 cm), straight edge with guards
- 27-984 DOWNING Cartilage Knife 10" (25.4 cm), concave edge with guards



27-990
27-992

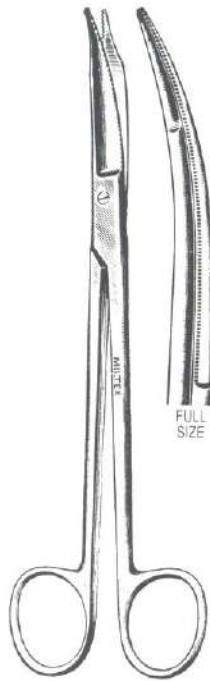

27-1000

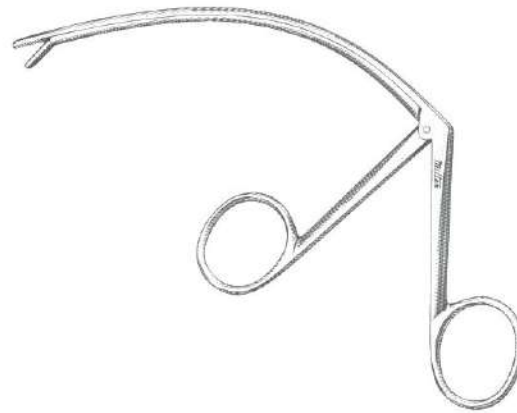

27-1016



27-1020 to 27-1028

- 27-990 MARTIN Cartilage Clamp 7" (17.8 cm)
- 27-992 MARTIN Cartilage Clamp 8" (20.3 cm)
- 27-1000 MARTIN Cartilage Scissors 8" (20.3 cm), serrated non-slip cutting edges
- 27-1016 MILTEX Tendon Pulling Forceps, 5" (12.7 cm) curved shaft, alligator type
- 27-1020 BUNNELL Tendon Stripper 6" (15.2 cm), inside dia. 3 mm
- 27-1022 BUNNELL Tendon Stripper 6" (15.2 cm), inside dia. 4 mm
- 27-1024 BUNNELL Tendon Stripper 6" (15.2 cm), inside dia. 5 mm
- 27-1026 BUNNELL Tendon Stripper 6" (15.2 cm), inside dia. 6 mm
- 27-1028 BUNNELL Tendon Stripper 6" (15.2 cm), inside dia. 7 mm

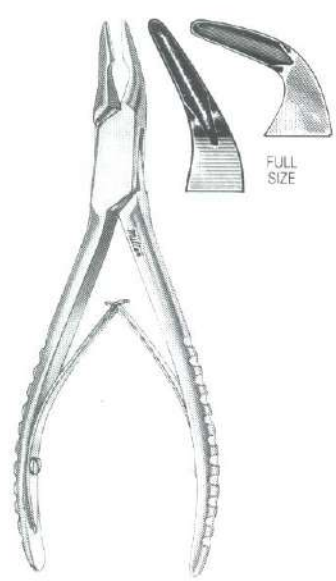

22-480 to 22-482

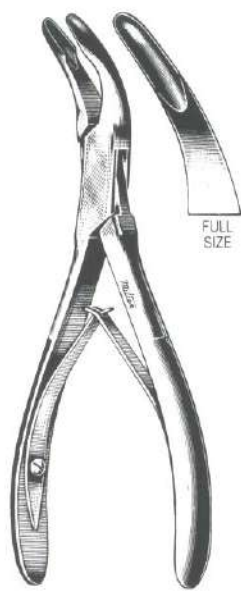

19-804

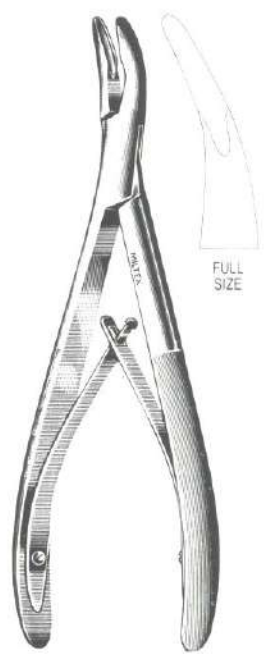

19-808

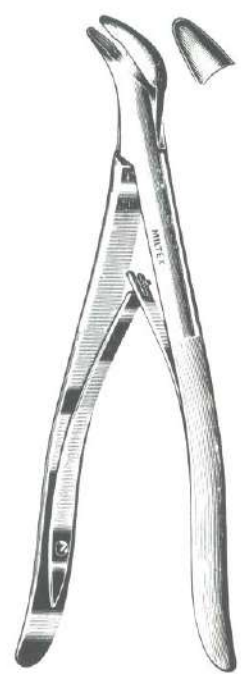

26-198

DEAN (BLUMENTHAL) RONGEURS 6" (15.2 cm),
 3 x 10 mm bite tapered to 4 mm
22-480 slightly curved jaws
22-482 jaws 90° angled

22-481 CICHERELLI (REINER) Rongeur 7" (17.8 cm),
 slightly curved jaws 3 x 8 mm bite tapered to 4 mm

19-804 HARTMAN Rongeur 5¾" (14.6 cm), strong curve,
 4 x 12 mm bite

19-808 BANE Rongeur 7" (17.8 cm), curved jaws,
 5 x 15 mm bite tapered to 7 mm

26-198 BACON Rongeur 8¼" (21 cm), angled on side,
 5 mm bite

26-190 LUER Rongeur 7" (17.8 cm), straight jaws 8 mm bite

26-192 LUER Rongeur 7" (17.8 cm), curved jaws 8 mm bite

22D-420 BLUMENTHAL Rongeur 6" (15.2 cm), 45° angled jaws
 3 x 12 mm bite

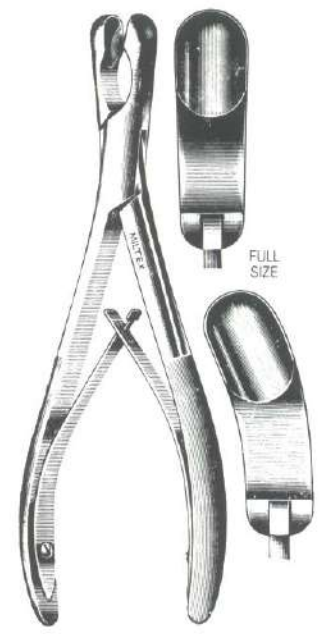

26-190 to 26-192

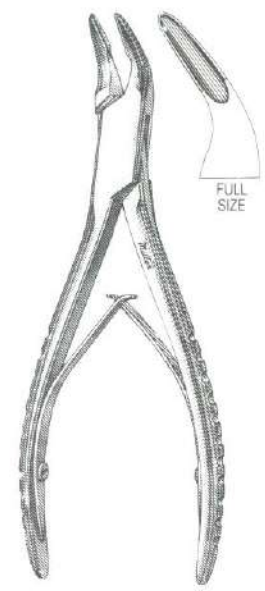

22D-420

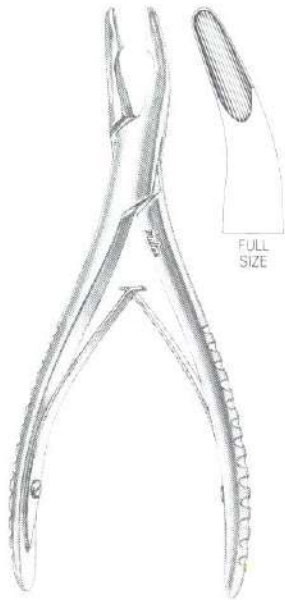

22-484

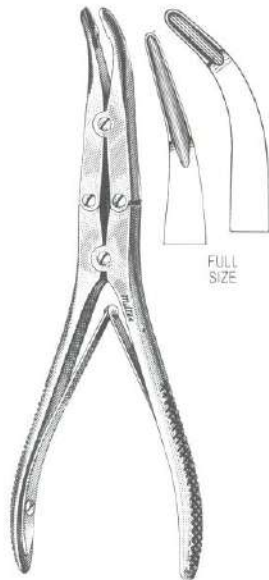

27-1295
27-1297

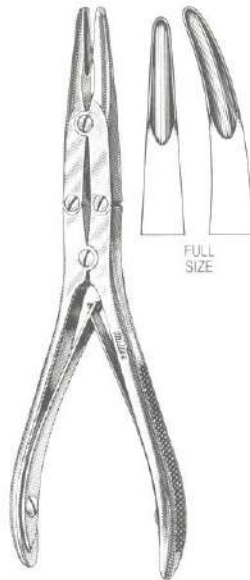

19-848
19-849

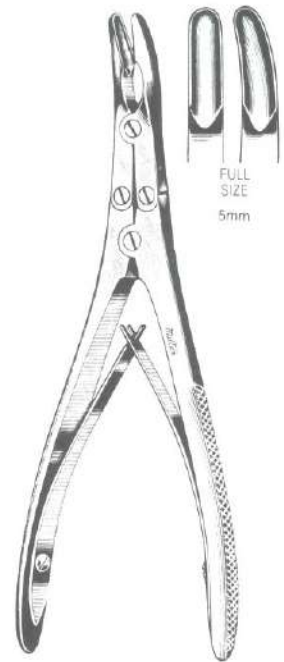

19-850 to 19-856

- 22-484 MEAD Rongeur 6½" (16.5 cm), slightly angled jaws 4 x 12 mm bite
- 27-1295 KLEINERT-KUTZ Bone Rongeur 6" (15.2 cm), slightly curved jaws 2 x 13 mm
- 27-1297 KLEINERT-KUTZ Synovectomy Rongeur 6" (15.2 cm), full curved jaws 3 x 8 mm

RUSKIN RONGEURS

Straight	Sizes	Curved
19-848	6" (15.2 cm) long, 3 mm bite	19-849
19-850	7¼" (18.4 cm) long, 5 mm bite	19-852
19-854	7¼" (18.4 cm) long, 7 mm bite	19-856

- 19-840 ZAUFEL-JANSEN Rongeur 7" (17.8 cm), slightly curved jaws 5 mm wide

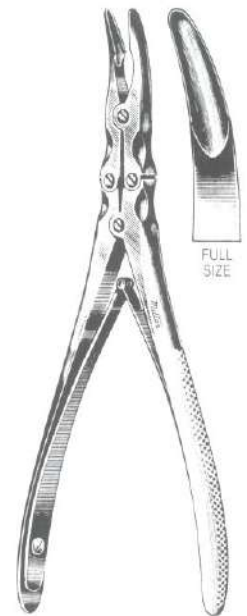

19-840



19-844



25-510
25-511

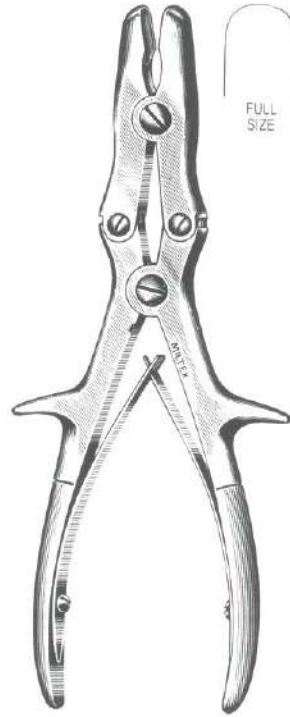

25-454

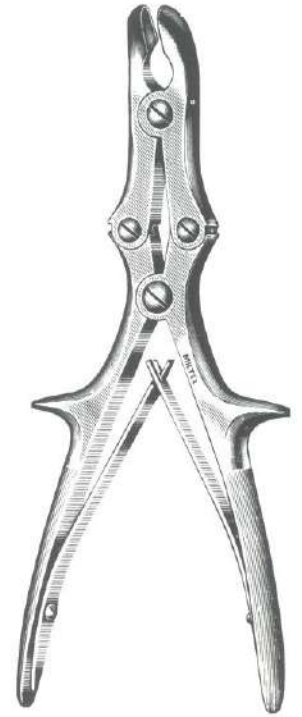

25-456

19-844

BEYER Rongeur 7" (17.8 cm), slightly curved jaws 3.5 mm wide

25-510

LEKSELL Laminectomy Rongeur 9½" (24.1 cm), standard curve, 3 mm bite

25-511

LEKSELL Laminectomy Rongeur 9½" (24.1 cm), standard curve, 8 mm bite

25-454

STILLE-LUER Rongeur 8¾" (22.2 cm), straight jaws 9 x 15 mm

25-456

STILLE-LUER Rongeur 8¾" (22.2 cm), curved jaws 9 x 15 mm

25-458

STILLE-LUER Duckbill Rongeur 9" (22.9 cm), angled on side jaws 6 x 12 mm

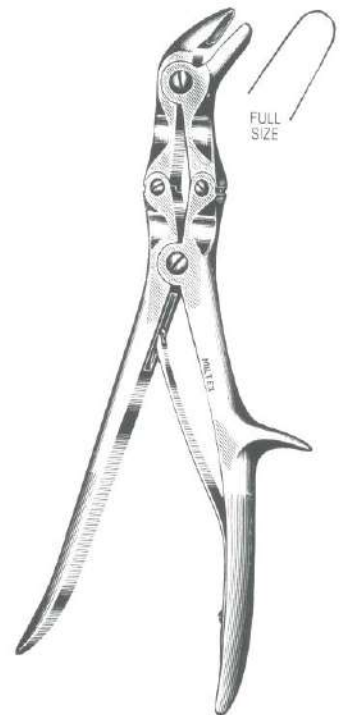

25-458

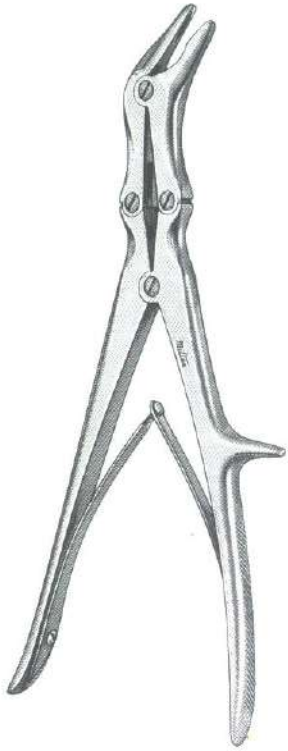

26-264 to 26-266



40-227-SS

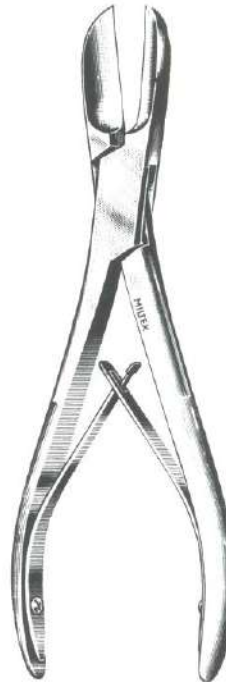

27-1390 to 27-1394

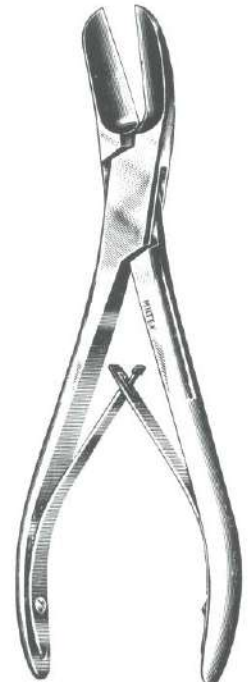

27-1400 to 27-1404

- 26-264 ECHLIN Duckbill Rongeur 9" (22.9 cm), 2 mm bite
- 26-265 ECHLIN Duckbill Rongeur 9" (22.9 cm), 3 mm bite
- 26-266 ECHLIN Duckbill Rongeur 9" (22.9 cm), 4 mm bite

- 40-227-SS LITTAUER-LISTON Bone Cutting Forceps 6" (15.2 cm), straight 20 mm blades

LISTON BONE CUTTING FORCEPS

Straight	Size	Angled on Flat
27-1390	5½" (14 cm)	27-1400
27-1392	7½" (19.1 cm)	27-1402
27-1394	8½" (21.6 cm)	27-1404

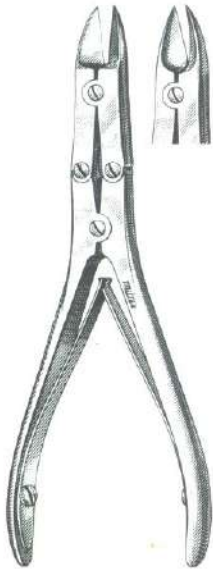

21-626
21-627

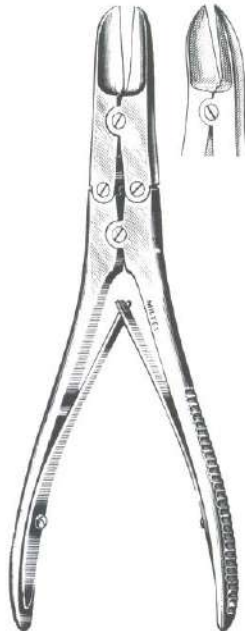

25-384
25-385

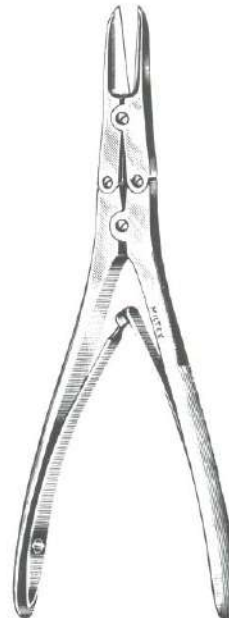

21-628

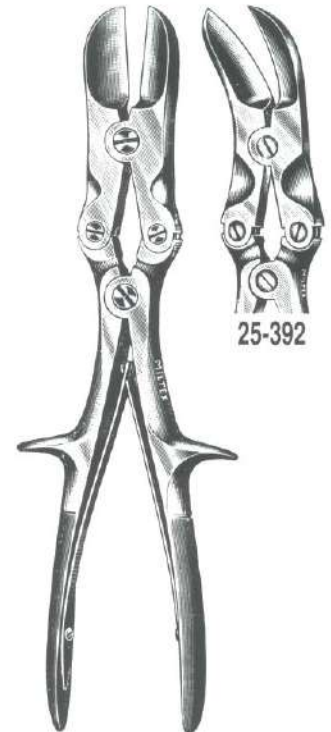

25-390

25-392

RUSKIN BONE CUTTING FORCEPS

Straight	Size	Angled
21-626	standard blades 5½" (14 cm)	21-627
25-384	standard blades 7½" (19.1 cm)	25-385
21-628	delicate blades 7½" (19.1 cm)	—
25-390	STILLE-LISTON Bone Cutting Forceps 10¾" (27.3 cm), straight	
25-392	STILLE-LISTON Bone Cutting Forceps 10¾" (27.3 cm), curved	
25-396	STILLE-HORSLEY Bone Cutting Forceps 10½" (26.7 cm), angled blades	



25-396

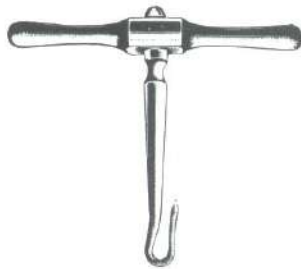

26-119



26-120



26-122



26-124

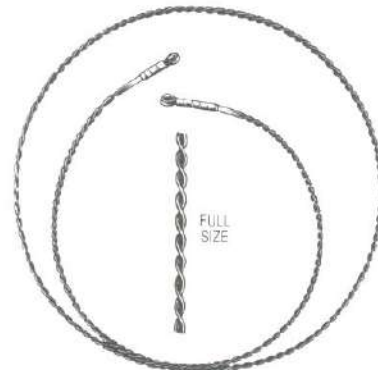

26-130 to 26-134

- 26-119 Gigli Saw Handle, Standard Pattern, T-shape, turnable
- 26-120 Gigli-STRULLY Saw Handle, T-shape, rigid, with snap lock
- 26-122 Gigli-STRULLY Saw Handle, T-shape, turnable, with snap lock
- 26-124 Gigli-STRULLY Saw Handle, Loop Grip, rigid, with snap lock
- 26-130 Gigli Saw 12" (30.5 cm), standard twisted wire type
- 26-132 Gigli Saw 20" (50.8 cm), standard twisted wire type
- 26-134 Gigli Saw 30" (76.2 cm), standard twisted wire type
- 26-138 BAILEY Gigli Saw Guide 12" (30.5 cm), flexible

- 65-28 Mesh Holder, 6³/₄" (17.1 cm), 2¹/₈" (5.4 cm) inside diameter of basket, securely holds small items such as micro clips, screws, burs etc., during cleaning, rinsing or sterilization



26-138



65-28



27-1550



40-2000



27-1560

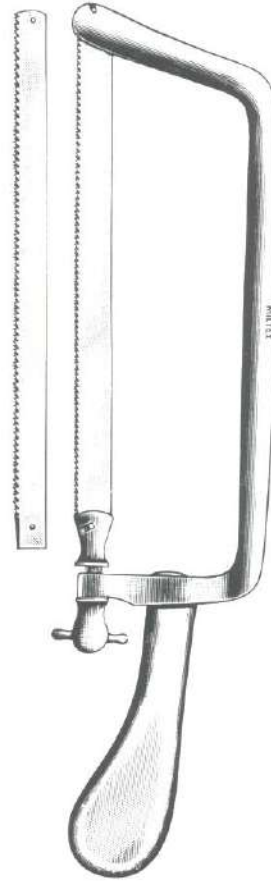

27-1564

27-1565-12

27-1565-18



27-1600

27-1602

27-1550 LANGENBECK Metacarpal Saw 9¼" (23.5 cm), blade 4½" (11.4 cm) long

40-2000 MILTEX Bone Saw 6" (15.2 cm), blade 2" (5.1 cm)

27-1560 SATTERLEE Bone Saw 12" (30.5 cm), light metal handle with stainless 9" (22.9 cm) blade

27-1561 Blade for No. 27-1560 Satterlee Saw

27-1564 CHARRIERE Bone Saw 14" (35.6 cm), with one each 12 mm and 18 mm stainless blades

27-1565-12 12 mm wide blade for No. 27-1564 saw

27-1565-18 18 mm wide blade for No. 27-1564 saw

27-1600 LISTON Amputating Knife 11¾" (29.8 cm), with 6½" (16.5 cm) blade

27-1602 LISTON Amputating Knife 13¾" (34.9 cm), with 8" (20.3 cm) blade



27-3002



27-3004



27-3020



27-3022

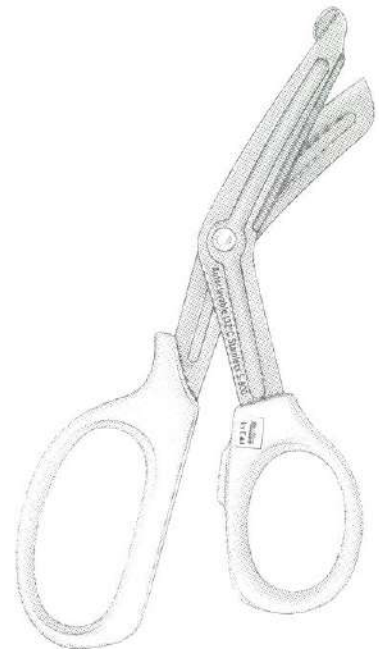

5-800

27-3002 U.S. Pattern Cast Knife 5½" (14 cm), wood handle, 1½" (3.8 cm) blade

27-3004 REINER Cast Knife 7" (17.8 cm), metal handle, 1½" (3.8 cm) blade

27-3020 ENGEL Cast Saw 6" (15.2 cm)

27-3022 WIGMORE Cast Saw 7¾" (19.7 cm)

5-800 Bandage and Utility Scissors 8½" (21.6 cm), with fluoride coated blades to help prevent adhesive or fiberglass casting material from sticking to the blade surfaces. Neon green plastic finger rings, serrated blade. Autoclavable.

5-998 Utility and Light Cast Shears 6½" (16.5 cm), black plastic finger rings, serrated blade. Autoclavable.

5-1000 Utility and Light Cast Shears 7½" (19.1 cm), black plastic finger rings, serrated blade. Autoclavable.

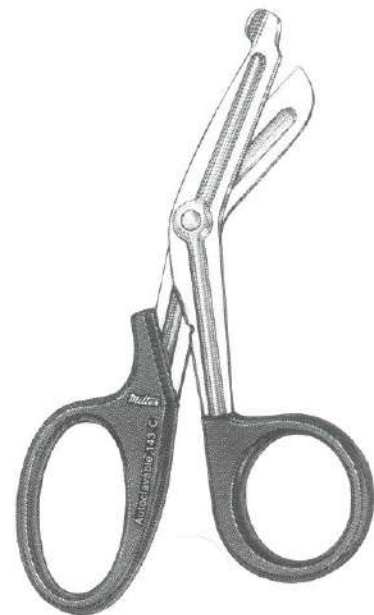

5-998

5-1000



5-568



5-547



27-3070



5-600

- 5-568 ESMARCH Cast Shears 8" (20.3 cm)
- 5-547 HERCULES Cast Shears 7½" (19.1 cm), serrated blade
- 27-3070 BRUNS Cast Shears 9¼" (23.5 cm), serrated blade
- 5-600 MILTEX Cast and Utility Shears 8½" (21.6 cm), with wire cutter and serrated blade
- 27-3059 STILLE Cast Shears 8" (20.3 cm), Pediatric Size, serrated blades
- 27-3060 STILLE Cast Shears 11" (27.9 cm), Medium Size, serrated blades
- 27-3062 STILLE Cast Shears 15" (38.1 cm), Standard Size, serrated blades



27-3059 to 27-3062



27-3080



27-3090



27-3094



27-3100

- 27-3080 WOLFE-BOEHLER Cast Breaker 10" (25.4 cm), jaws 15 mm wide with deep serrations
- 27-3090 BEESON Cast Spreader 12" (30.5 cm), blades 2" (5.1 cm) wide
- 27-3094 HENNIG Cast Spreader 11" (27.9 cm), blades 2" (5.1 cm) wide
- 27-3100 MILTEK 3-Prong Cast Spreader 9" (22.9 cm), with spring action for one-hand operation

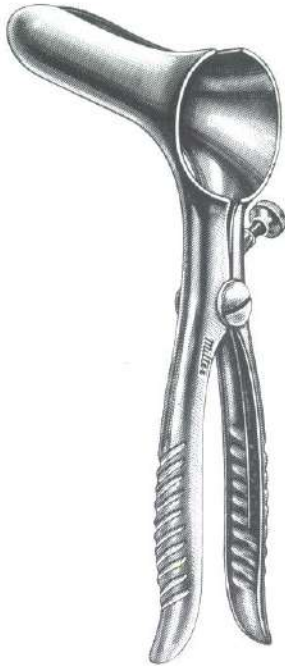

28-1

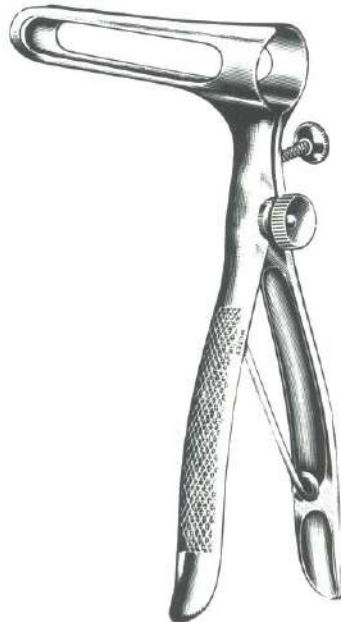

28-2



28-4



28-6

28-1 PRATT Rectal Speculum 8½" (21.6 cm) long, with set screw, blades 3½" (8.9 cm) long x 1" (2.5 cm) wide at distal end

28-2 SIMS Rectal Speculum 6" (15.2 cm) long, with set screw, fenestrated blades 3½" (8.9 cm) long x ⅝" (1.6 cm) wide at distal end

28-4 BODENHAMMER Rectal Speculum 6" (15.2 cm) long, with set screw, blades 3½" (8.9 cm) long x ¾" (1.9 cm) wide at distal end

28-6 BARR Anal Retractor 8" (20.3 cm), self-retaining, blades 2¾" (7 cm) x ⅞" (2.2 cm)

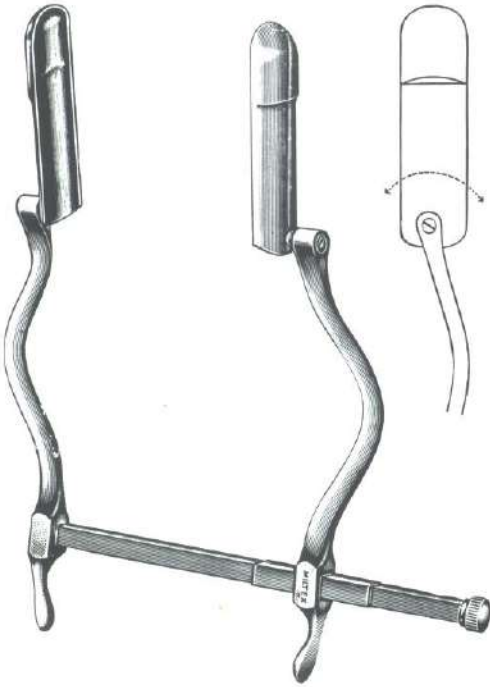

28-64
28-65



28-70 to 28-74

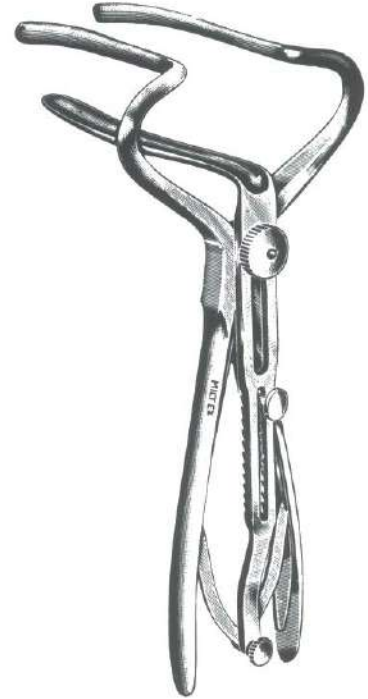

28-8

- 28-64 SMITH (BUIE) Anal Retractor, self-retaining, swivel blades 2½" (6.4 cm) x 7⁄8" (2.2 cm) open to 4" (10.2 cm)
- 28-65 SMITH (BUIE) Anal Retractor, self-retaining, extra long swivel blades 4" (10.2 cm) x 7⁄8" (2.2 cm) open to 4" (10.2 cm)
- 28-70 SAWYER Rectal Retractor 11" (27.9 cm), blade 7⁄8" (2.2 cm) x 2½" (6.4 cm)
- 28-72 SAWYER Rectal Retractor 11" (27.9 cm), blade 1⅛" (2.8 cm) x 3" (7.6 cm)
- 28-74 SAWYER Rectal Retractor 11" (27.9 cm), blade 1½" (3.8 cm) x 3½" (8.9 cm)
- 28-8 COOK Rectal Retractor 8" (20.3 cm), triple bladed, self-retaining, 4" (10.2 cm) deep blades, lower blade ½" (1.3 cm) wide



28-10



28-12



28-14

- 28-10 PENNINGTON Rectal Speculum $3\frac{3}{8}$ " (8.6 cm) long x 1" (2.5 cm) O.D., with boilable obturator, $4\frac{3}{4}$ " (12.1 cm) long handle, chrome
- 28-11 Obturator for No. 28-10 Pennington Speculum
- 28-12 FANSLER-IVES Rectal Speculum $3\frac{1}{4}$ " (8.3 cm) long x $1\frac{1}{8}$ " (2.8 cm) O.D., with boilable obturator, $2\frac{3}{4}$ " (7 cm) long handle, chrome
- 28-14 Obturator for No. 28-12 Fansler-Ives Speculum
- 28-20 HIRSCHMAN Anoscope, Small size $2\frac{1}{4}$ " (5.7 cm) long x $\frac{9}{16}$ " (1.4 cm) I.D.
- 28-22 HIRSCHMAN Anoscope, Medium size $2\frac{5}{8}$ " (6.7 cm) long x $1\frac{1}{16}$ " (1.7 cm) I.D.
- 28-24 HIRSCHMAN Anoscope, Large size $3\frac{1}{2}$ " (8.9 cm) long x $\frac{7}{8}$ " (2.2 cm) I.D.



28-20 to 28-24

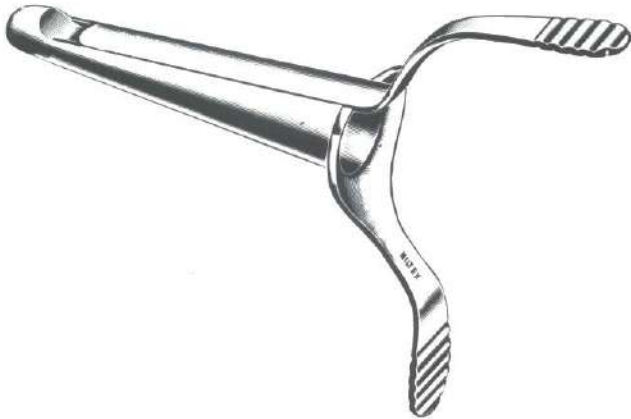

28-30 to 28-34



28-36
28-38

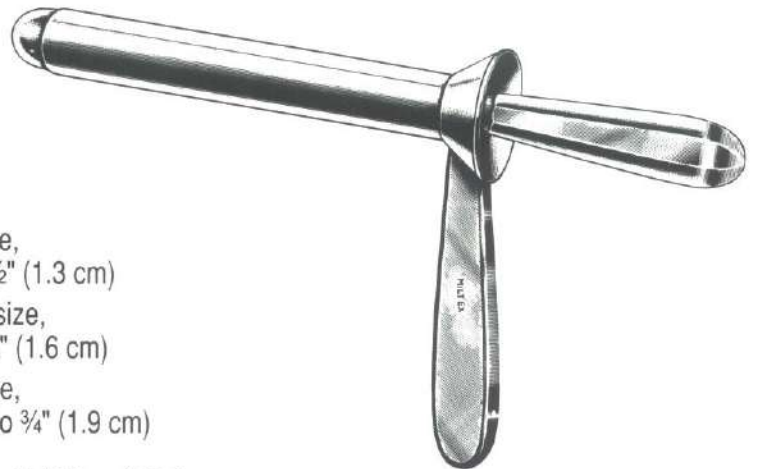

28-40
28-44

- 28-30 BRINKERHOFF Rectal Speculum, Small size, 3½" (8.9 cm) long x 1" (2.5 cm) tapering to ½" (1.3 cm)
- 28-32 BRINKERHOFF Rectal Speculum, Medium size, 4" (10.2 cm) long x 1" (2.5 cm) tapering to 5⁄8" (1.6 cm)
- 28-34 BRINKERHOFF Rectal Speculum, Large size, 4¾" (12.1 cm) long x 1¼" (3.2 cm) tapering to ¾" (1.9 cm)
- 28-36 KELLY Sphincteroscope 2⅛" (5.4 cm) long x 1" (2.5 cm) O.D. tapering to 1⅜" (2.1 cm)
- 28-38 KELLY Sphincteroscope 2¼" (5.7 cm) long x 1¼" (3.2 cm) O.D. tapering to 1" (2.5 cm)
- 28-40 KELLY Anoscope 2" (5.1 cm) long x 7⁄8" (2.2 cm) O.D.
- 28-44 KELLY Proctoscope 5½" (14 cm) long x 7⁄8" (2.2 cm) O.D.



- 28-48 HIRSCHMAN Proctoscope 5" (12.7 cm)
long x 1⁵/₁₆" (2.4 cm) O.D.
- 28-50 FANSLER Operating Speculum 2³/₈" (6.1 cm)
long x 1³/₈" (3.5 cm) O.D., slotted tube
- 28-52 BARR-SHUFORD Rectal Speculum 4¹/₂" (11.4 cm)
tapered from 5⁵/₈" (1.6 cm) to 2" (5.1 cm), chrome
- 28-68 HILL-FERGUSON Retractor 8¹/₂" (21.6 cm), small blade,
2.2 x 6.4 cm
- 28-69 HILL-FERGUSON Retractor 8³/₄" (22.2 cm), large blade,
3 x 7.6 cm
- 28-79 CHELSEA EATON Anal Speculum 2⁵/₈" (6.7 cm)
long x 7⁷/₈" (2.2 cm) O.D.
- 28-80 CHELSEA EATON Anal Speculum 2⁵/₈" (6.7 cm)
long x 1¹/₄" (3.2 cm) O.D.





28-100



28-104



28-106



28-108



28-109



28-120
28-122
28-124



28-128
28-130

- 28-100 LARRY Probe and Grooved Director 7" (17.8 cm)
- 28-104 BARR Fistula Probe, with 8" (20.3 cm) sterling shaft, eye at tip, 11½" (29.2 cm) overall
- 28-106 BUIE Fistula Probe, with 5½" (14 cm) sterling shaft, 6¾" (17.1 cm) overall
- 28-108 PRATT Rectal Probe, with 7¾" (19.7 cm) sterling shaft, 11" (27.9 cm) overall
- 28-109 BARR Double Ended Probe 7" (17.8 cm), rigid
- 28-120 PRATT Crypt Hook 8½" (21.6 cm), narrow style
- 28-122 PRATT Crypt Hook 8½" (21.6 cm), short style
- 28-124 PRATT Crypt Hook 8½" (21.6 cm), long style
- 28-128 STEWART Crypt Hook 8½" (21.6 cm), short style
- 28-130 STEWART Crypt Hook 8½" (21.6 cm), long style
- 28-131 ROSSER Crypt Hook 6¾" (17.1 cm)
- 28-140 BARR Crypt Hook 10" (25.4 cm), short and long hook ends

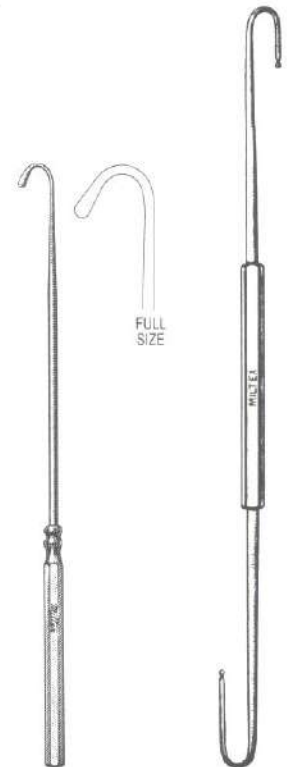

28-131

28-140

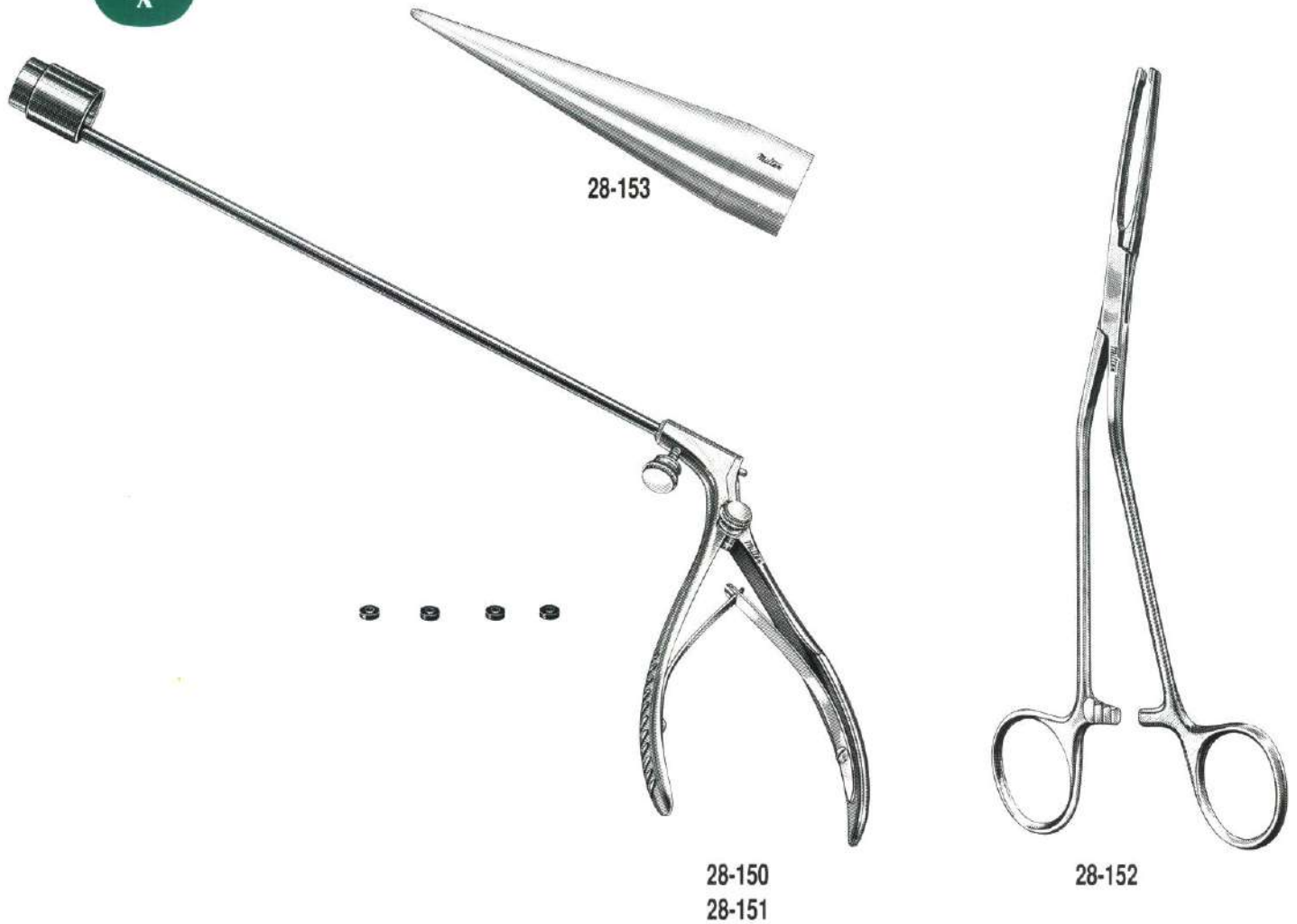

- 28-150 McGIVNEY Hemorrhoidal Ligator, improved model with offset handle for better vision and comfort. 7" (17.8 cm) working length. Can be disassembled entirely for cleaning. Supplied with drum loading cone and 100 Latex O-Rings.
- 28-151 Latex O-Rings for No. 28-150 Ligator. Bag with 100 rings.
- 28-152 McGIVNEY Hemorrhoid Grasping Forceps 7½" (19.1 cm), angled shanks. Specially designed for use with McGivney Ligator.
- 28-153 Loading Cone for No. 28-150 Ligator

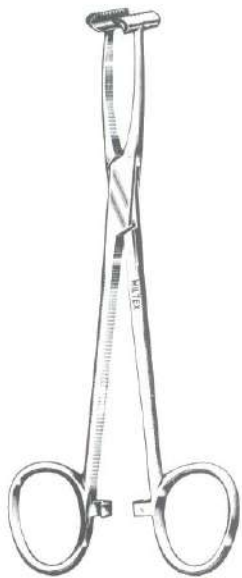

7-106

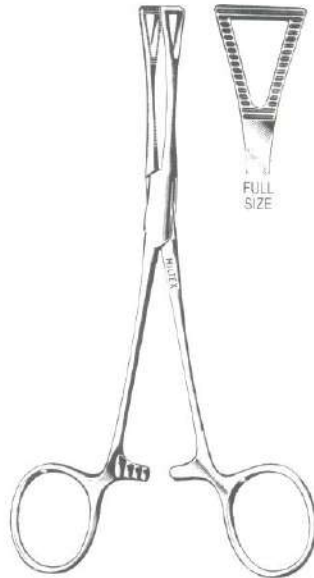

7-220

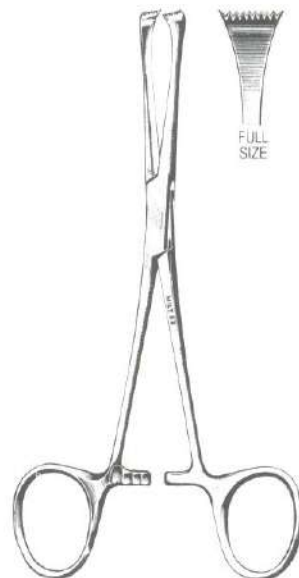

16-30

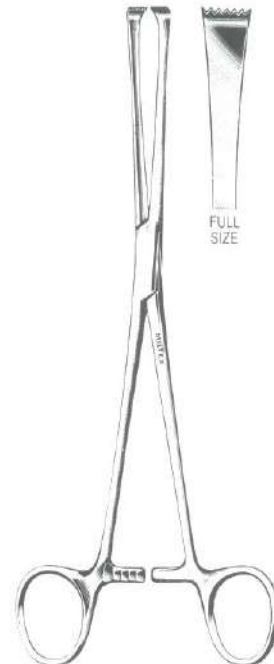

16-38

- 7-106 PRATT T-Shape Tissue Grasping Forceps 6" (15.2 cm)
- 7-220 PENNINGTON Tissue Grasping Forceps 6" (15.2 cm), triangular jaws
- 16-30 ADAIR-ALLIS Tissue Forceps 6½" (16.5 cm), 9 x 10 teeth
- 16-38 THOMS-ALLIS Tissue Forceps 8" (20.3 cm), 6 x 7 teeth



16-10
16-24



28-196



28-200

- 16-10 ALLIS Tissue Forceps 7¼" (18.4 cm), 5 x 6 teeth, straight
- 16-24 ALLIS Tissue Forceps 7¼" (18.4 cm), 5 x 6 teeth, 90° angled jaws
- 28-196 BUIE Pile Clamp 8½" (21.6 cm), curved angiotribe jaws
- 28-200 FERGUSON Tenaculum Forceps 6¾" (17.1 cm), straight jaws
- 7-260 FERGUSON Angiotribe Forceps 6½" (16.5 cm), straight
- 7-262 FERGUSON Angiotribe Forceps 6½" (16.5 cm), curved
- 7-264 FERGUSON Angiotribe Forceps 7½" (19.1 cm), straight
- 7-266 FERGUSON Angiotribe Forceps 7½" (19.1 cm), curved

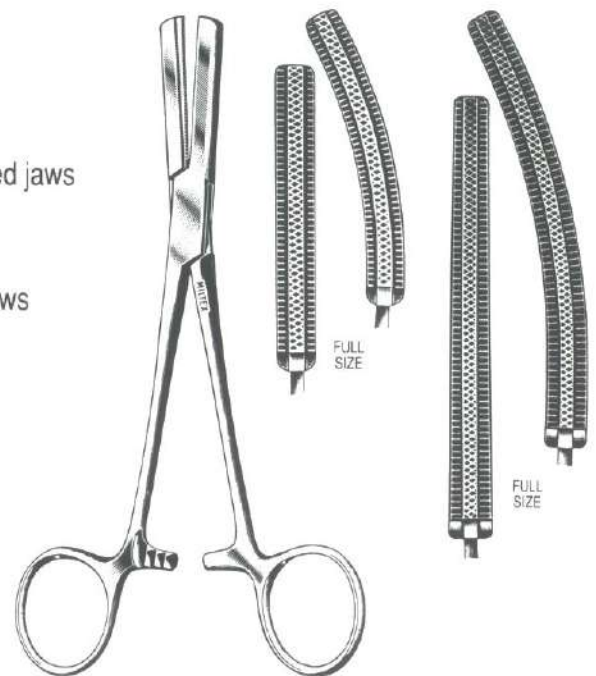

7-260 to 7-266



- 28-240** MILLER Rectal Scissors 6¾" (17.1 cm), bayonet shape, delicate serrated blades with blunt points
- 28-244** PRATT Rectal Scissors 8¼" (21 cm), S-shaped, blunt points
- 5-250** KELLY Rectal Scissors 6¼" (15.9 cm), sharp points, straight
- 5D-251** KELLY Rectal Scissors 6¼" (15.9 cm), sharp points, straight, with one serrated blade
- 5-252** KELLY Rectal Scissors 6¼" (15.9 cm), sharp points, curved
- 5D-253** KELLY Rectal Scissors 6¼" (15.9 cm), sharp points, curved, with one serrated blade

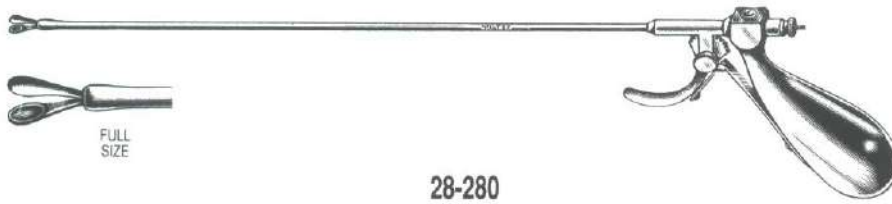

- 28-280** BUIE Biopsy Forceps 13" (33 cm) shaft, 3.5 mm bite
- 28-294** YEOMAN Biopsy Forceps 9" (22.9 cm) shaft, 3.5 x 10 mm bite, with basket
- 28-296** YEOMAN Biopsy Forceps 13" (33 cm) shaft, 3.5 x 10 mm bite, with basket
- 28-298** YEOMAN Biopsy Forceps 15" (38.1 cm) shaft, 3.5 x 10 mm bite, with basket



FULL
SIZE

28-300
28-302
28-304
28-306
28-308
28-310



FULL
SIZE

28-320
28-322
28-324
28-326
28-328
28-330

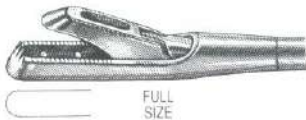

FULL
SIZE

28-303
28-309



FULL
SIZE

28-323
28-329



28-340

YEOMAN BIOPSY FORCEPS with ROTATING SHAFTS, Straight 4 x 8 mm Bite, With Basket

Complete with Ring Handle	Shaft Length	Shaft Only
28-300	10" (25.4 cm)	28-306
28-302	14" (35.6 cm)	28-308
28-303	14" (35.6 cm) with teeth	28-309
28-304	16" (40.6 cm)	28-310

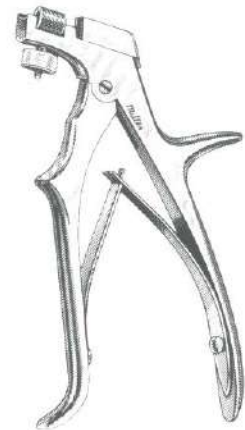

28-341

TURRELL BIOPSY FORCEPS with ROTATING SHAFTS, Angled Jaws 4 x 8 mm Bite, With Basket

Complete with Ring Handle	Shaft Length	Shaft Only
28-320	10" (25.4 cm)	28-326
28-322	14" (35.6 cm)	28-328
28-323	14" (35.6 cm) with teeth	28-329
28-324	16" (40.6 cm)	28-330

28-340 Ring Handle fitting Yeoman and Turrell Biopsy Forceps Nos. 28-300 to 28-330

28-341 Pistol Grip Handle fitting Yeoman and Turrell Biopsy Forceps Nos. 28-300 to 28-330

NOTE: All parts of Nos. 28-300 through 28-341 are interchangeable



28-380 to 28-416

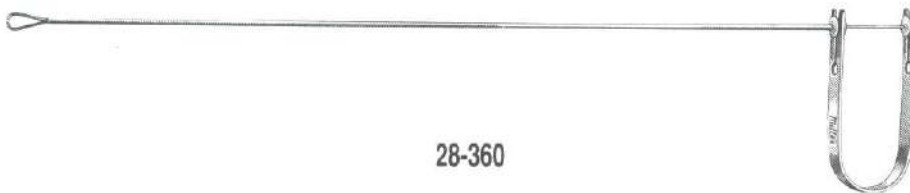

28-360

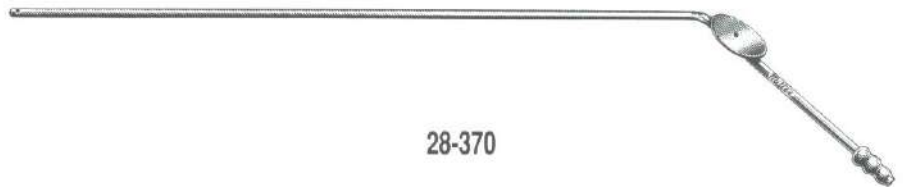

28-370

MILTEX IMPROVED BIOPSY FORCEPS with ROTATING SHAFTS in Pistol Grip Spring Handle. Shafts easily disassembled from handle. Constructed without small assembly parts. All shafts and handles are interchangeable.

	Complete with Pistol Grip Handle	Shaft Length	Jaws 3.5 x 10 mm Bite	Shaft only
	28-380	25.4 cm (10")	straight	28-410
	28-382	35.6 cm (14")	straight	28-412
	28-384	25.4 cm (10")	angled	28-414
	28-386	35.6 cm (14")	angled	28-416
28-400	Pistol Grip Spring Handle for Miltex Improved Biopsy Forceps Nos. 28-380 through 28-416. This handle also fits Uterine Biopsy Forceps Nos. 30-1490 to 30-1495.			
28-360	Rectal Cotton Carrier, 15" (38.1 cm) shaft, with spring action			
28-370	BUIE Suction Tube 16" (40.6 cm), with finger valve, 15 Fr. (5 mm)			

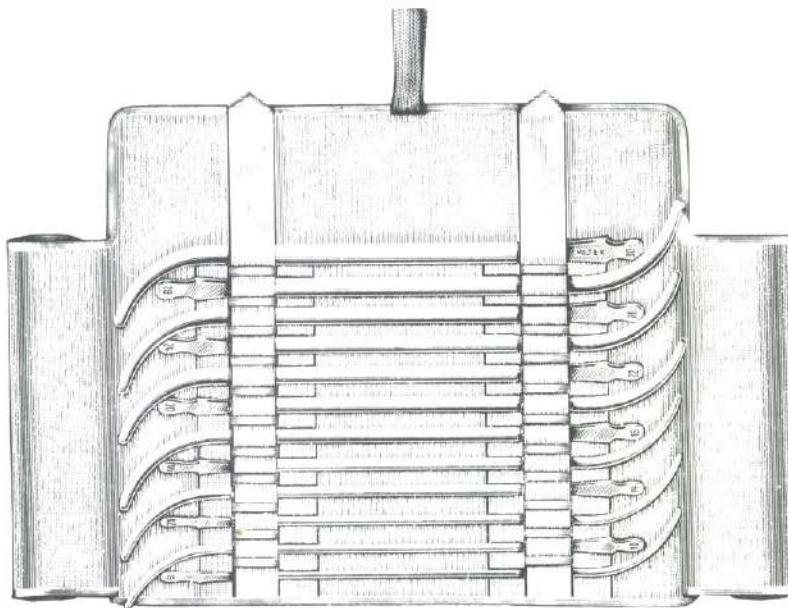

29-2
29-4



29-6



29-8

VAN BUREN URETHRAL SOUNDS 11" (27.9 cm)

- 29-2** Set of 6 Sounds in Khaki Roll, even sizes 14 Fr. (4.6 mm) to 24 Fr. (8 mm)
29-4 Set of 12 Sounds in Khaki Roll, even sizes 8 Fr. (2.6 mm) to 30 Fr. (10 mm)

29-6-8	8 Fr. (2.6 mm)	29-6-20	20 Fr. (6.6 mm)	29-6-32	32 Fr. (10.6 mm)
29-6-10	10 Fr. (3.3 mm)	29-6-22	22 Fr. (7.3 mm)	29-6-34	34 Fr. (11.2 mm)
29-6-12	12 Fr. (4 mm)	29-6-24	24 Fr. (8 mm)	29-6-36	36 Fr. (11.9 mm)
29-6-14	14 Fr. (4.6 mm)	29-6-26	26 Fr. (8.6 mm)	29-6-38	38 Fr. (12.5 mm)
29-6-16	16 Fr. (5.3 mm)	29-6-28	28 Fr. (9.2 mm)	29-6-40	40 Fr. (13.2 mm)
29-6-18	18 Fr. (6 mm)	29-6-30	30 Fr. (10 mm)		

DITTEL URETHRAL SOUNDS 11½" (29.2 cm), STRAIGHT

29-8-8	8 Fr. (2.6 mm)	29-8-18	18 Fr. (6 mm)	29-8-28	28 Fr. (9.2 mm)
29-8-10	10 Fr. (3.3 mm)	29-8-20	20 Fr. (6.6 cm)	29-8-30	30 Fr. (9.9 mm)
29-8-12	12 Fr. (4 mm)	29-8-22	22 Fr. (7.3 mm)	29-8-32	32 Fr. (10.6 mm)
29-8-14	14 Fr. (4.6 mm)	29-8-24	24 Fr. (8 mm)	29-8-34	34 Fr. (11.2 mm)
29-8-16	16 Fr. (5.3 mm)	29-8-26	26 Fr. (8.6 mm)		

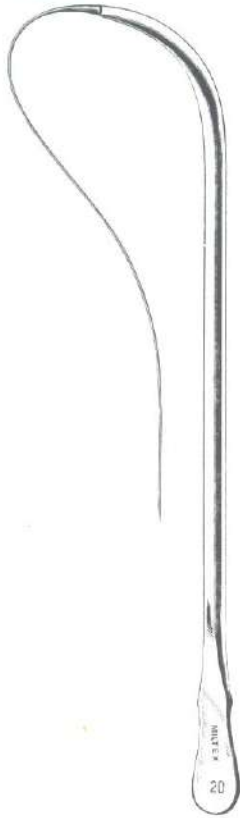

29-10



29-14



29-18

LEFORT URETHRAL SOUNDS 11" (27.9 cm),
With Standard 1-56 Thread for Filiform (not included)

29-10-8	8 Fr. (2.6 mm)	29-10-20	20 Fr. (6.6 mm)
29-10-10	10 Fr. (3.3 mm)	29-10-22	22 Fr. (7.3 mm)
29-10-12	12 Fr. (4 mm)	29-10-24	24 Fr. (8 mm)
29-10-14	14 Fr. (4.6 mm)	29-10-26	26 Fr. (8.6 mm)
29-10-16	16 Fr. (5.3 mm)	29-10-28	28 Fr. (9.2 mm)
29-10-18	18 Fr. (6 mm)	29-10-30	30 Fr. (10 mm)

McCREA INFANT URETHRAL SOUNDS
7" (17.8 cm) CURVED, PLAIN TIP
Also used as Female Sounds

29-14-8	8 Fr. (2.6 mm)	29-14-24	24 Fr. (8 mm)
29-14-10	10 Fr. (3.3 mm)	29-14-26	26 Fr. (8.6 mm)
29-14-12	12 Fr. (4 mm)	29-14-28	28 Fr. (9.2 mm)
29-14-14	14 Fr. (4.6 mm)	29-14-30	30 Fr. (10 mm)
29-14-16	16 Fr. (5.3 mm)	29-14-32	32 Fr. (10.6 mm)
29-14-18	18 Fr. (6 mm)	29-14-34	34 Fr. (11.2 mm)
29-14-20	20 Fr. (6.6 mm)	29-14-36	36 Fr. (11.9 mm)
29-14-22	22 Fr. (7.3 mm)		

WALTHER URETHRAL SOUNDS 11" (27.9 cm)
Shaft Tapered Downward toward Handle

29-18-16	16 Fr. (5.3 mm)	29-18-28	28 Fr. (9.2 mm)
29-18-18	18 Fr. (6 mm)	29-18-30	30 Fr. (9.9 mm)
29-18-20	20 Fr. (6.6 mm)	29-18-32	32 Fr. (10.6 mm)
29-18-22	22 Fr. (7.3 mm)	29-18-34	34 Fr. (11.2 mm)
29-18-24	24 Fr. (8 mm)	29-18-36	36 Fr. (11.9 mm)
29-18-26	26 Fr. (8.6 mm)		



29-32



29-33

- 29-32-8 Female Catheter 5 $\frac{3}{4}$ " (14.6 cm), Size 8 Fr. (2.6 mm)
- 29-32-10 Female Catheter 5 $\frac{3}{4}$ " (14.6 cm), Size 10 Fr. (3.3 mm)
- 29-32-12 Female Catheter 5 $\frac{3}{4}$ " (14.6 cm), Size 12 Fr. (4 mm)
- 29-32-14 Female Catheter 5 $\frac{3}{4}$ " (14.6 cm), Size 14 Fr. (4.6 mm)
- 29-32-16 Female Catheter 5 $\frac{3}{4}$ " (14.6 cm), Size 16 Fr. (5.3 mm)
- 29-32-18 Female Catheter 5 $\frac{3}{4}$ " (14.6 cm), Size 18 Fr. (6 mm)

WALTHER FEMALE DILATOR-CATHETERS 5 $\frac{1}{4}$ " (13.3 cm)

- | | | | | | |
|----------|-----------------|----------|-----------------|----------|------------------|
| 29-33-12 | 12 Fr. (4 mm) | 29-33-22 | 22 Fr. (7.3 mm) | 29-33-32 | 32 Fr. (10.6 mm) |
| 29-33-14 | 14 Fr. (4.6 mm) | 29-33-24 | 24 Fr. (8 mm) | 29-33-34 | 34 Fr. (11.2 mm) |
| 29-33-16 | 16 Fr. (5.3 mm) | 29-33-26 | 26 Fr. (8.6 mm) | 29-33-36 | 36 Fr. (11.9 mm) |
| 29-33-18 | 18 Fr. (6 mm) | 29-33-28 | 28 Fr. (9.2 mm) | 29-33-38 | 38 Fr. (12.5 mm) |
| 29-33-20 | 20 Fr. (6.6 mm) | 29-33-30 | 30 Fr. (10 mm) | | |



29-48



29-72

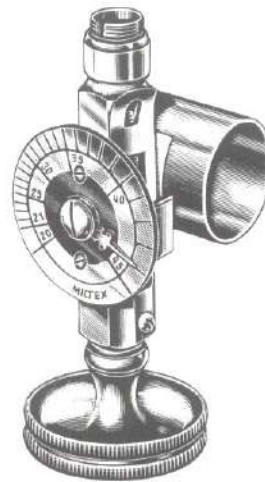

29-78

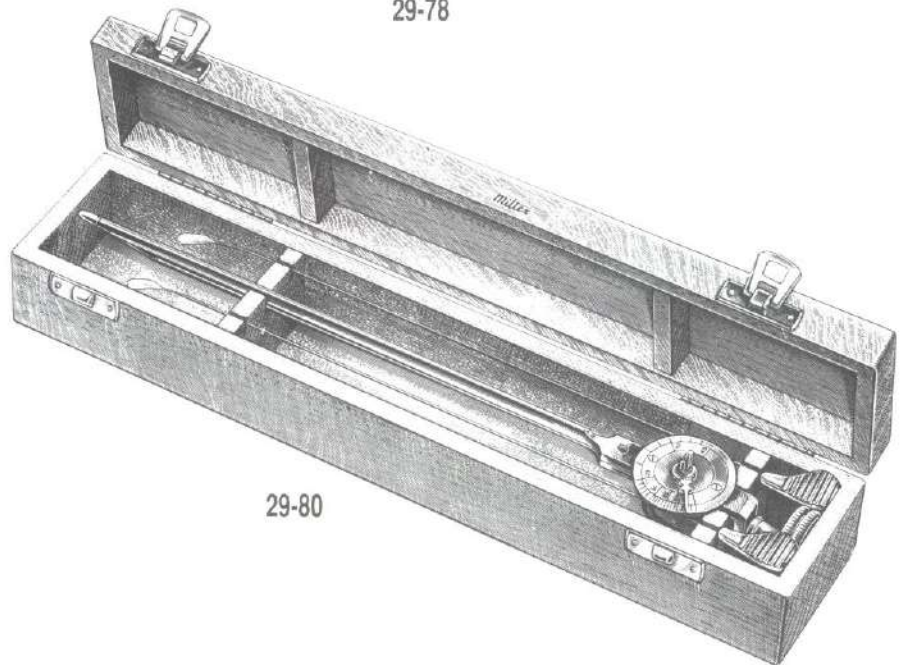

29-80

- 29-48 VAN BUREN Catheter Guide 17" (43.2 cm), size 8 Fr. (2.6 mm)
- 29-72 KOLLMANN Urethral Dilator 10" (25.4 cm), curved, dilates from 20 Fr. (6.6 mm) to 45 Fr. (14.9 mm), uses Handle No. 29-78
- 29-78 KOLLMANN Dilator Handle, adjustable from 20 Fr. (6.6 mm) to 45 Fr. (14.9 mm), for use with Dilator No. 29-72
- 29-80 OTIS Urethrotome, straight, with 2 knife blades, adjusts from 20 Fr. (6.6 mm) to 45 Fr. (14.9 mm) 11" (27.9 cm) working length. In fitted wooden case
- 29-81 OTIS Urethrotome Replacement Blade

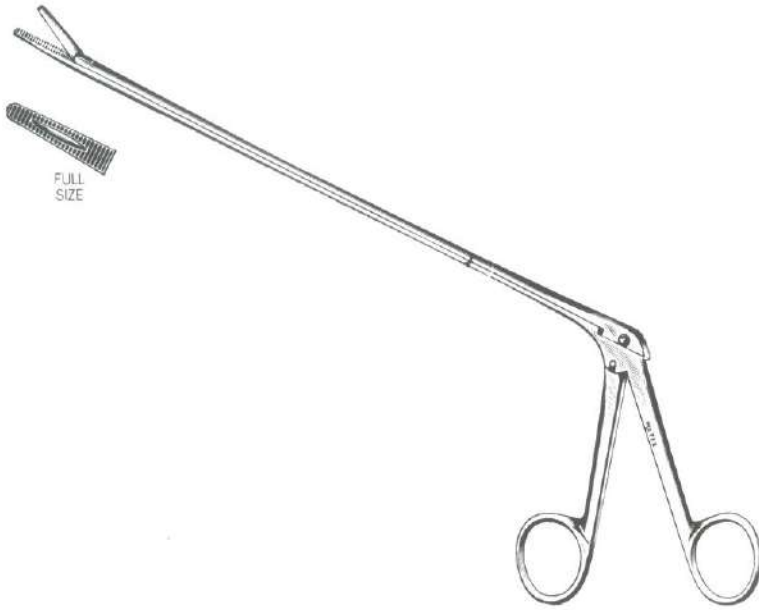

29-102

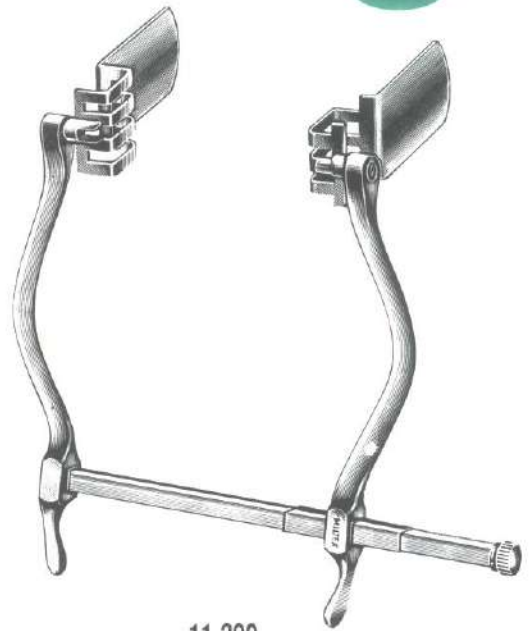

11-390

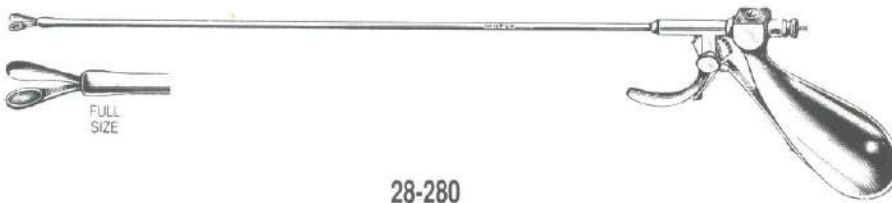

28-280

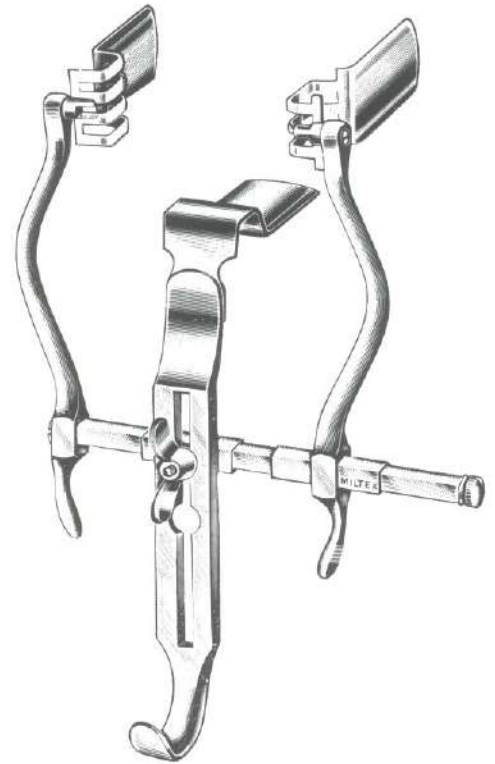

11-392

- 29-102** MATHIEU Urethral Forceps 11½" (29.2 cm) shaft, serrated jaws 3.5 mm x 17 mm
- 28-280** BRAASCH (BUJE) Bladder Biopsy Forceps 13" (33 cm) shaft, 3.5 mm cup jaws
- 11-390** MASSON-JUDD Bladder Retractor, with 2 swivel blades 1" (2.5 cm) x 2¾" (7 cm)
- 11-392** MASSON-JUDD Bladder Retractor, with 2 swivel blades and center blade 1" (2.5 cm) x 2¾" (7 cm)



8-102

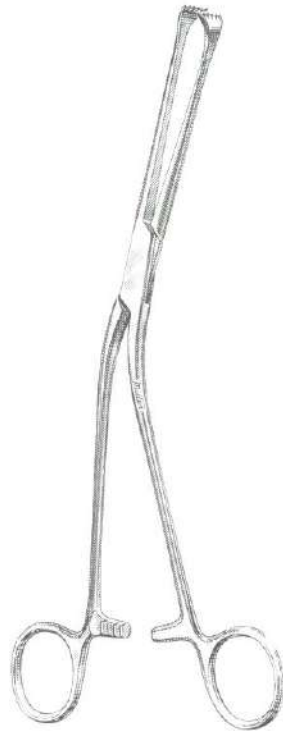

29-232



29-280



29-282

- 8-102 STRATTE Needle Holder 9" (22.9 cm), double curved jaws and bent shanks
- 29-232 MILLIN Capsule Holding Forceps 9½" (24.1 cm), jaws 11 mm wide, 9 x 10 teeth
- 29-280 WERTHEIM Pedicle Clamp 9¾" (24.8 cm), curved jaws 2" (5.1 cm) long
- 29-282 WERTHEIM-CULLEN Pedicle Clamp 8½" (21.6 cm), right angle jaws 2" (5.1 cm) long
- 29-284 RANDALL Kidney Stone Forceps 9¼" (23.5 cm), quarter curved
- 29-286 RANDALL Kidney Stone Forceps 8¼" (21 cm), half curved
- 29-288 RANDALL Kidney Stone Forceps 7¾" (19.7 cm), three quarter curved
- 29-290 RANDALL Kidney Stone Forceps 7½" (19.1 cm), full curved



29-284 to 29-290

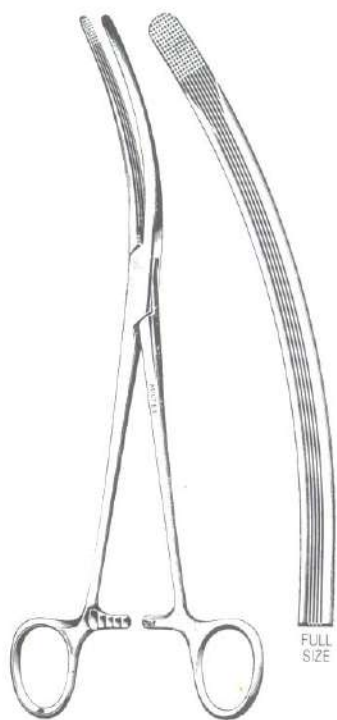

29-300



29-302



29-304



29-308

29-300 YOUNG Renal Pedicle Clamp 9" (22.9 cm), curved, longitudinal serrations with cross serrations at tip

29-302 STILLE Pattern Vessel Clamp 9" (22.9 cm)

29-304 HERRICK Kidney Pedicle Clamp 9½" (24.1 cm), double angle jaws, serrated

29-308 MAYO (GUYON) Vessel Clamp 9¼" (23.5 cm), double curved jaws, serrated

29-310TC BIHRLE Dorsal Clamp – Tungsten Carbide Needle Holder 11" (27.9 cm). Designed to aid in the fixation and suturing of the dorsal vein complex during retropubic prostatectomy for prostate cancer during cystectomy.

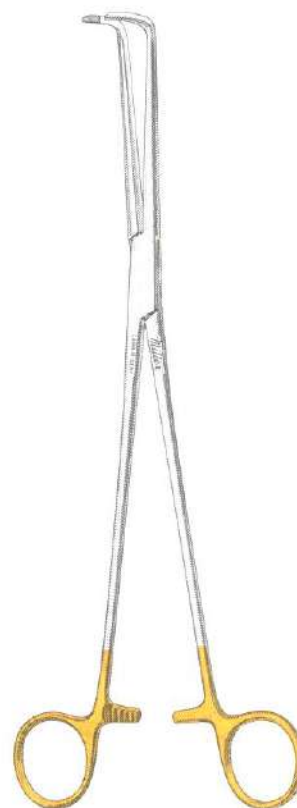

29-310TC



30-10 to 30-20

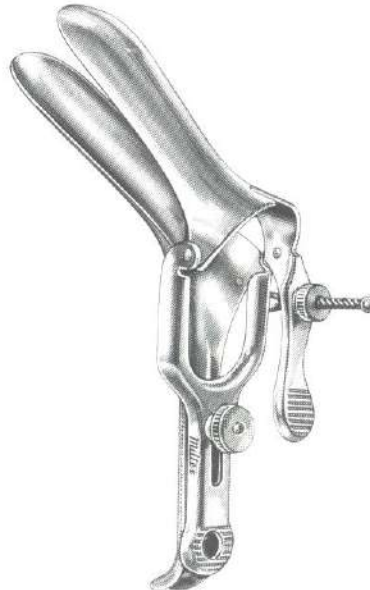

30-25

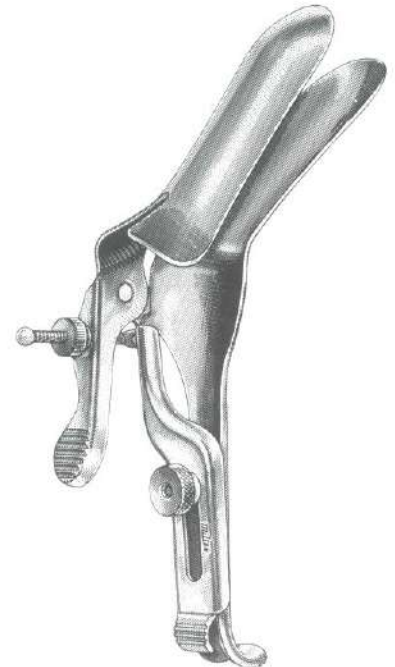

30-30

GRAVES VAGINAL SPECULA, ORIGINAL MODEL

- | | |
|--------|--|
| 30-10 | Small Size, $\frac{3}{4}$ " (1.9 cm) x 3" (7.6 cm) |
| 30-15 | Medium Size $1\frac{3}{8}$ " (3.5 cm) x 4" (10.2 cm) |
| 30-20 | Large Size $1\frac{1}{2}$ " (3.8 cm) x $4\frac{1}{2}$ " (11.4 cm) |
| 30-10B | GRAVES Vaginal Speculum, Small Size $\frac{3}{4}$ " (1.9 cm) x 3" (7.6 cm), ebony finish |
| 30-15B | GRAVES Vaginal Speculum, Medium Size $1\frac{3}{8}$ " (3.5 cm) x 4" (10.2 cm), ebony finish |
| 30-20B | GRAVES Vaginal Speculum, Large Size $1\frac{1}{2}$ " (3.8 cm) x $4\frac{1}{2}$ " (11.4 cm), ebony finish |
| 30-25 | GRAVES Improved Vaginal Speculum, Medium Size $1\frac{3}{8}$ " (3.5 cm) x 4" (10.2 cm), wide angle blades |
| 30-30 | GRAVES Open Side Vaginal Speculum, Medium Size $1\frac{3}{8}$ " (3.5 cm) x 4" (10.2 cm), wide angle blades |



30-50 to 30-62



30-75 to 30-85



30-70
30-90 to 30-100

PEDERSON VAGINAL SPECULA, NARROW BLADES

30-50	Small Size,	½" (1.3 cm) x 3" (7.6 cm)
30-55	Medium Size	⅞" (2.2 cm) x 4" (10.2 cm)
30-60	Large Size	1" (2.5 cm) x 4¾" (12.1 cm)
30-62	PEDERSON Extra Narrow Vaginal Speculum ⅝" (1.6 cm) x 4" (10.2 cm) blades	

CUSCO VAGINAL SPECULA, with Folding Handles

With Center Screw		Blade Sizes	With Side Screw
—	Extra Narrow	¾" (1.9 cm) x 3¼" (8.3 cm)	30-70
30-75	Small	1¼" (3.2 cm) x 3½" (8.9 cm)	30-90
30-80	Medium	1⅜" (3.5 cm) x 4" (10.2 cm)	30-95
30-85	Large	1⅝" (3.5 cm) x 4½" (11.4 cm)	30-100

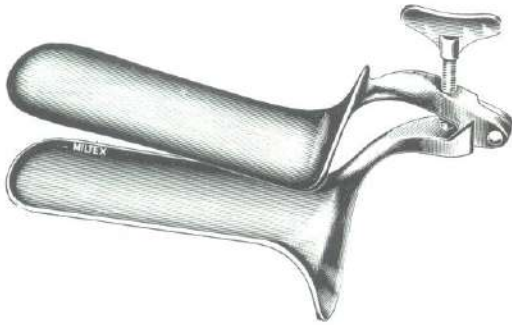

30-120 to 30-130

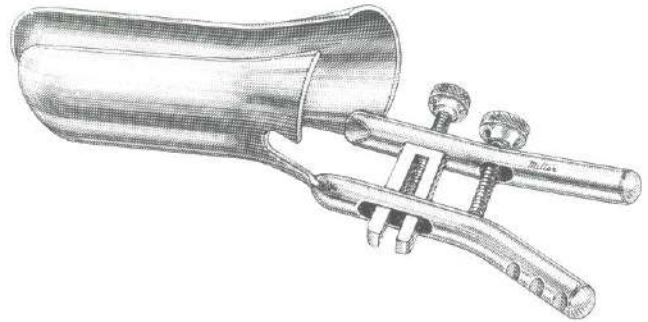

30-140 to 30-142

- 30-120 COLLIN Vaginal Speculum, Small Size 1¼" (3.2 cm) x 3¾" (9.5 cm)
- 30-125 COLLIN Vaginal Speculum, Medium Size 1¾" (3.5 cm) x 4" (10.2 cm)
- 30-130 COLLIN Vaginal Speculum, Large Size 1⅝" (4.1 cm) x 4½" (11.4 cm)

DeVILBISS Vaginal Specula

Two sets of screws permit parallel, or bivalve opening of the blades, for examination or operative use

- 30-140 Small Size, 3½" (8.9 cm) x ⅞" (2.2 cm) blades
- 30-141 Medium Size, 4" (10.2 cm) x 1¼" (3.2 cm) blades
- 30-142 Large Size, 5" (12.7 cm) x 1⅜" (3.5 cm) blades

- 30-180 GUTMANN Vaginal Speculum, Examining Type, 1⅜" (3.5 cm) x 4" (10.2 cm), self-retaining

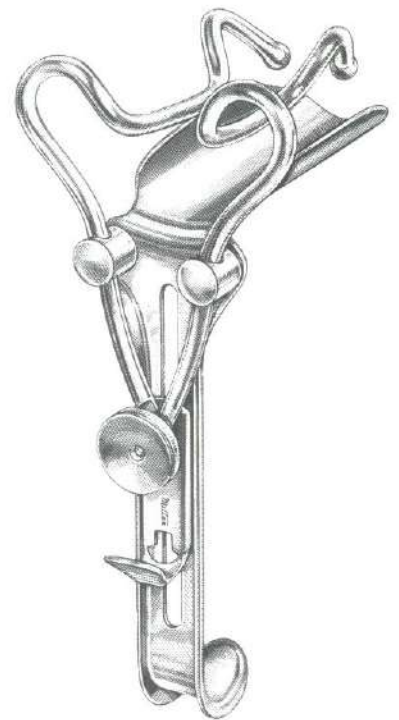

30-180



30-174 to 30-178

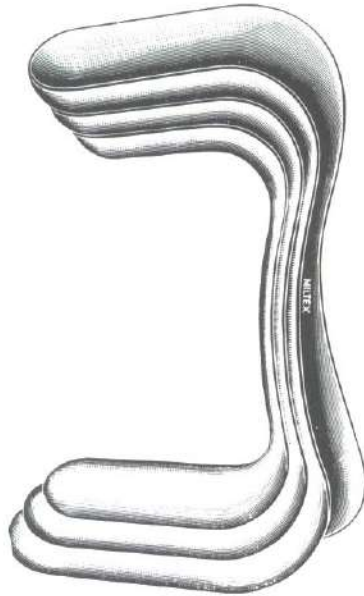

30-210 to 30-220

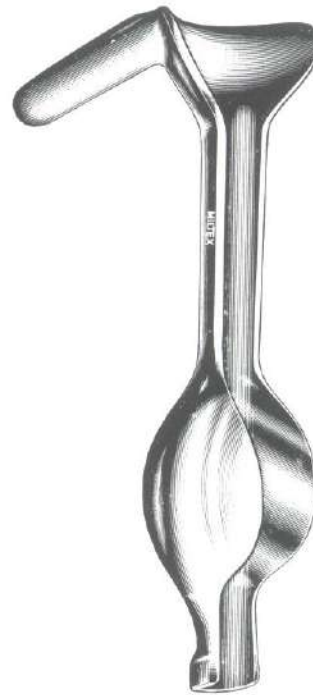

30-186 to 30-188

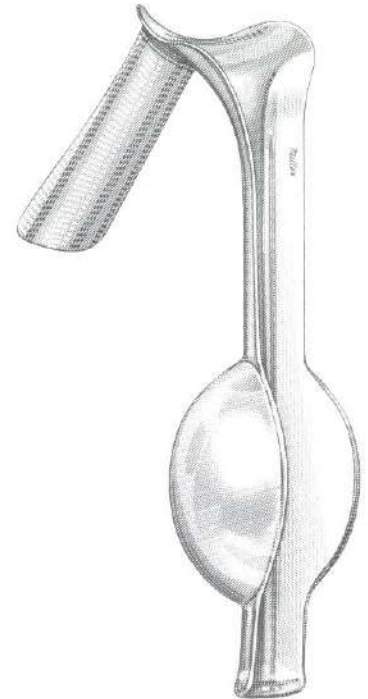

30-193

- 30-174 SIMS Vaginal Speculum, Single End, Small Size 1¹/₁₆" (2.7 cm) x 2¹/₂" (6.4 cm)
- 30-176 SIMS Vaginal Speculum, Single End, Medium Size 1¹/₄" (3.2 cm) x 3" (7.6 cm)
- 30-178 SIMS Vaginal Speculum, Single End, Large Size 1¹/₂" (3.8 cm) x 3¹/₂" (8.9 cm)

30-210 SIMS Vaginal Speculum, Double End, Small Size 1" (2.5 cm) x 2¹/₂" (6.4 cm) and 1¹/₄" (3.2 cm) x 3" (7.6 cm)

30-215 SIMS Vaginal Speculum, Double End, Medium Size 1¹/₈" (2.8 cm) x 3" (7.6 cm) and 1¹/₄" (3.2 cm) x 3¹/₂" (8.9 cm)

30-220 SIMS Vaginal Speculum, Double End, Large Size 1³/₈" (3.5 cm) x 3¹/₂" (8.9 cm) and 1¹/₂" (3.8 cm) x 4" (10.2 cm)

AUVARD WEIGHTED VAGINAL SPECULA 9" (22.9 cm)

- 30-186 2 lbs. (909 g), straight blade 1¹/₂" (3.8 cm) x 3¹/₄" (8.3 cm), slightly angled (75°)
- 30-187 2.5 lbs. (1136 g), straight blade 1¹/₂" (3.8 cm) x 3¹/₄" (8.3 cm), slightly angled (75°)
- 30-188 3 lbs. (1363 g), straight blade 1¹/₂" (3.8 cm) x 3¹/₄" (8.3 cm), slightly angled (75°)

30-193 2.5 lbs. (1136 g), blade 4" (10.2 cm) long x 1³/₈" (3.8 cm) wide, tapering to 1³/₄" (4.4 cm) width at tip, blade at acute angle (45°)

30-195 STEINER-AUVARD weighted Vaginal Speculum, 2.5 lbs. (1136 g), slightly curved blade 5¹/₂" (14 cm) x 1¹/₄" (3.2 cm), at 90° angle

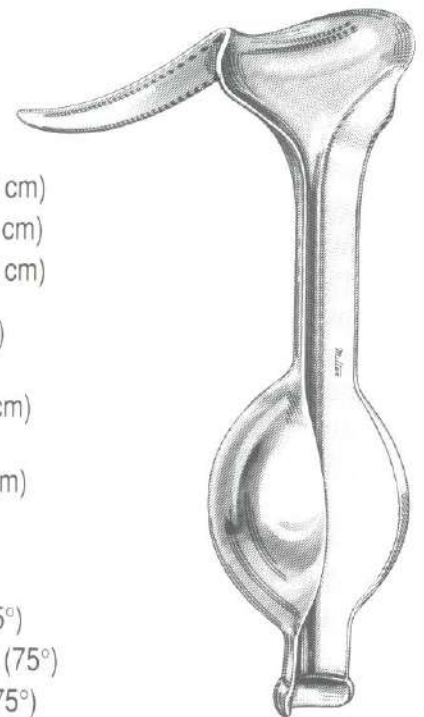

30-195



30-300 to 30-310



30-320 to 30-330

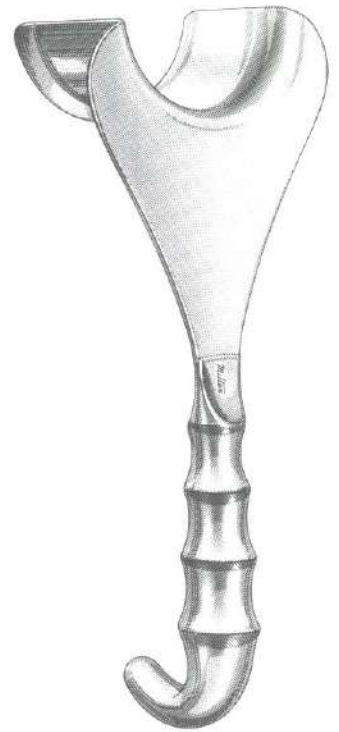

30-340

- 30-300 JACKSON Vaginal Retractor 7" (17.8 cm), Blade 1½" (3.8 cm) x 3" (7.6 cm)
- 30-305 JACKSON Vaginal Retractor 7" (17.8 cm), Blade 1½" (3.8 cm) x 3½" (8.9 cm)
- 30-310 JACKSON Vaginal Retractor 7" (17.8 cm), Blade 1½" (3.8 cm) x 4" (10.2 cm)
- 30-320 EASTMAN Vaginal Retractor 7" (17.8 cm), Blade 1½" (3.8 cm) x 3" (7.6 cm)
- 30-325 EASTMAN Vaginal Retractor 7" (17.8 cm), Blade 1½" (3.8 cm) x 3½" (8.9 cm)
- 30-330 EASTMAN Vaginal Retractor 7" (17.8 cm), Blade 1½" (3.8 cm) x 4" (10.2 cm)
- 30-340 DE LEE Universal Retractor 9½" (24.1 cm), Blade 2¾" (7 cm) x 2" (5.1 cm)
- 30-395 DOYEN Vaginal Retractor 9" (22.9 cm), Blade 1¾" (4.4 cm) x 2½" (6.4 cm)
- 30-406 DOYEN Vaginal Retractor 9" (22.9 cm), Blade 2⅛" (5.4 cm) x 3" (7.6 cm)
- 30-415 DOYEN Vaginal Retractor 9" (22.9 cm), Blade 2¼" (5.7 cm) x 3½" (8.9 cm)

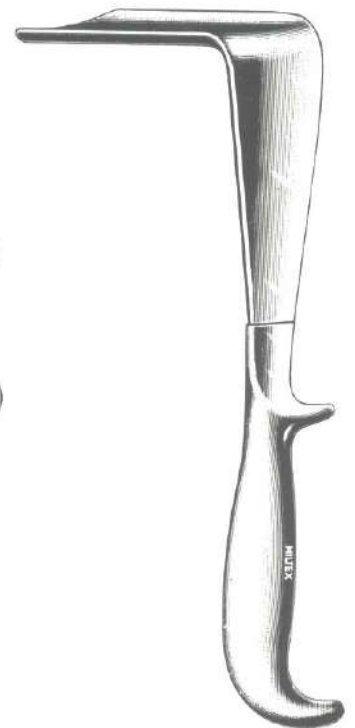

30-395 to 30-415



30-370

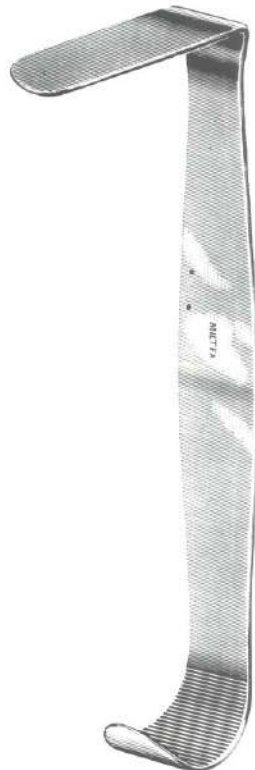

11-180 to 11-184

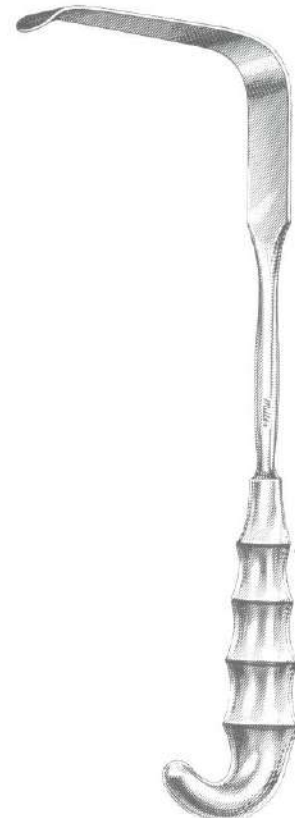

11-185

- 30-370** O'SULLIVAN-O'CONNOR Self-Retaining Vaginal Retractor, complete with 3 interchangeable blades $\frac{1}{2}$ " (1.3 cm) x $1\frac{7}{8}$ " (4.7 cm), $1\frac{1}{2}$ " (3.8 cm) x $3\frac{1}{2}$ " (8.9 cm) and $1\frac{3}{4}$ " (4.4 cm) x $3\frac{1}{2}$ " (8.9 cm)
- 11-180** HEANEY Hysterectomy Retractor $10\frac{1}{2}$ " (26.7 cm), Blade 1" (2.5 cm) x $1\frac{3}{4}$ " (4.4 cm)
- 11-182** HEANEY Hysterectomy Retractor $10\frac{1}{2}$ " (26.7 cm), Blade $1\frac{1}{8}$ " (2.8 cm) x $2\frac{7}{8}$ " (7.3 cm)
- 11-184** HEANEY Hysterectomy Retractor $10\frac{1}{2}$ " (26.7 cm), Blade $1\frac{1}{8}$ " (2.8 cm) x $3\frac{1}{4}$ " (8.3 cm)
- 11-185** HEANEY-SIMON Vaginal Retractor $11\frac{1}{2}$ " (29.2 cm), Blade 1" (2.5 cm) x $4\frac{1}{2}$ " (11.4 cm)



11-365
11-366

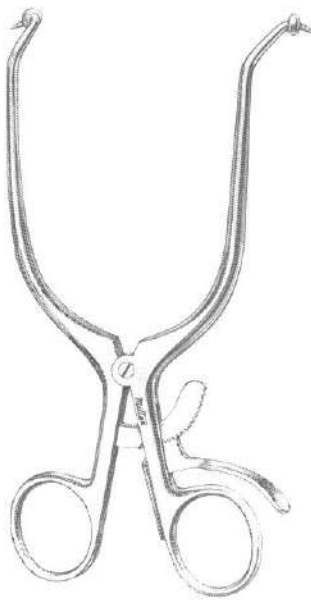

11-368



11-374

- 11-365 Pediatric GELPI Perineal Retractor 5½" (14 cm), with grip-lock
- 11-366 GELPI Perineal Retractor 6¾" (17.1 cm), with grip-lock
- 11-368 GELPI Perineal Retractor 6¾" (17.1 cm), with ball stops and grip-lock
- 11-374 RIGBY Vaginal Retractor 6¾" (17.1 cm), with grip-lock

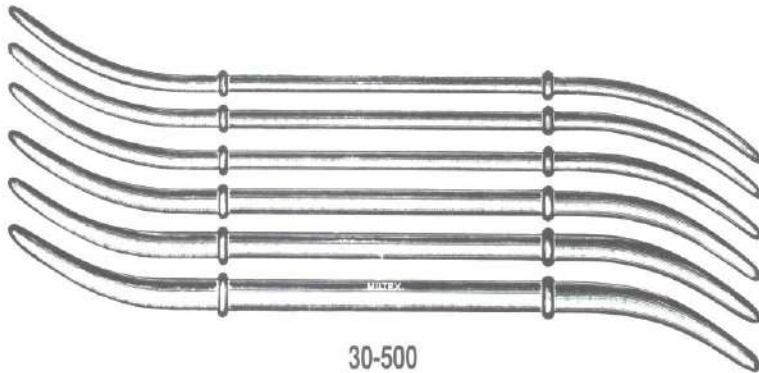

30-500
30-505



30-515 to 30-530

HANK UTERINE DILATORS 11" (27.9 CM), DOUBLE END

30-500 Set of 6 Dilators in Khaki Roll, Sizes 11-12, (3.6-4 mm), 13-14 (4.3-4.6 mm), 15-16 (5-5.3 mm), 17-18 (5.6-6 mm), 19-20 (6.3-6.6 mm), and 21-22 (7-7.3 mm) French

30-505-78	7-8 Fr. (2.3-2.6 mm)	30-505-1516	15-16 Fr. (5-5.3 mm)	30-505-2324	23-24 Fr. (7.6-8 mm)
30-505-910	9-10 Fr. (3-3.3 mm)	30-505-1718	17-18 Fr. (5.6-6 mm)	30-505-2526	25-26 Fr. (8.3-8.6 mm)
30-505-1112	11-12 Fr. (3.6-4 mm)	30-505-1920	19-20 Fr. (6.3-6.6 mm)	30-505-2728	27-28 Fr. (8.9-9.2 mm)
30-505-1314	13-14 Fr. (4.3-4.6 mm)	30-505-2122	21-22 Fr. (7-7.3 mm)	30-505-2930	29-30 Fr. (9.6-10 mm)

HEGAR UTERINE DILATORS 7" (17.8 cm), SINGLE END

30-515 Set of 14 Dilators in Khaki Roll, Sizes 4 to 17 mm

30-520 Set of 26 Dilators in Khaki Roll, Sizes 1 to 26 mm

30-530-1	1 mm	30-530-85	8.5 mm	30-530-16	16 mm
30-530-15	1.5 mm	30-530-9	9 mm	30-530-165	16.5 mm
30-530-2	2 mm	30-530-95	9.5 mm	30-530-17	17 mm
30-530-25	2.5 mm	30-530-10	10 mm	30-530-175	17.5 mm
30-530-3	3 mm	30-530-105	10.5 mm	30-530-18	18 mm
30-530-35	3.5 mm	30-530-11	11 mm	30-530-185	18.5 mm
30-530-4	4 mm	30-530-115	11.5 mm	30-530-19	19 mm
30-530-45	4.5 mm	30-530-12	12 mm	30-530-20	20 mm
30-530-5	5 mm	30-530-125	12.5 mm	30-530-21	21 mm
30-530-55	5.5 mm	30-530-13	13 mm	30-530-22	22 mm
30-530-6	6 mm	30-530-135	13.5 mm	30-530-23	23 mm
30-530-65	6.5 mm	30-530-14	14 mm	30-530-24	24 mm
30-530-7	7 mm	30-530-145	14.5 mm	30-530-25	25 mm
30-530-75	7.5 mm	30-530-150	15 mm	30-530-26	26 mm
30-530-8	8 mm	30-530-155	15.5 mm		

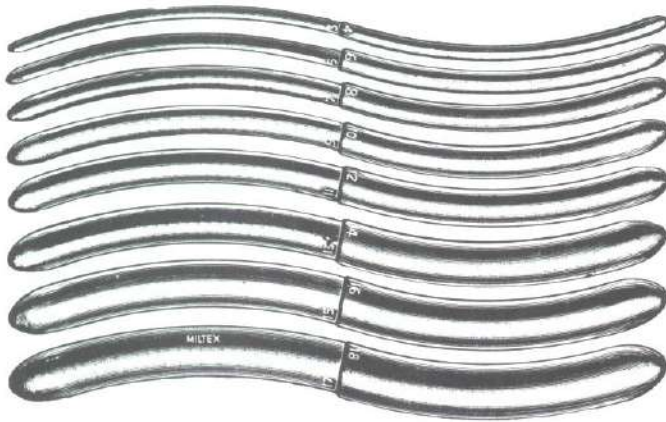

30-550
30-555



30-560
30-561

HEGAR UTERINE DILATORS 7½" (19.1 cm), DOUBLE END

30-550 Set of 8 Dilators in Khaki Roll, sizes 3-5 mm to 17-18 mm

30-555-34	3-4 mm	30-555-1112	11-12 mm
30-555-56	5-6 mm	30-555-1314	13-14 mm
30-555-78	7-8 mm	30-555-1516	15-16 mm
30-555-910	9-10 mm	30-555-1718	17-18 mm

PRATT UTERINE DILATORS 11½" (29.2 cm), DOUBLE END

30-561 Set of 8 Dilators in Khaki Roll, sizes 13-15 Fr. (4.3-5 mm) to 41-43 Fr. (13.5-14.2 mm)

30-560-1315	13-15 Fr. (4.3-4.6 mm)	30-560-2931	29-31 Fr. (9.6-10.2 mm)
30-560-1719	17-19 Fr. (5.6-6.3 mm)	30-560-3335	33-35 Fr. (10.9-11.6 mm)
30-560-2123	21-23 Fr. (7-7.6 mm)	30-560-3739	37-39 Fr. (12.2-12.9 mm)
30-560-2527	25-27 Fr. (8.3-9 mm)	30-560-4143	41-43 Fr. (13.5-14.2 mm)

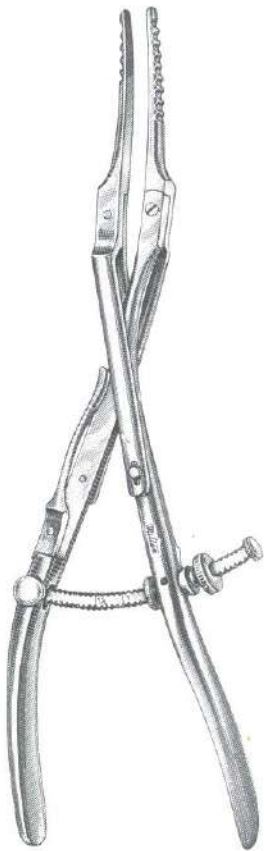

30-620
30-625



30-650



30-655



7-620



7-622

- 30-620 GOODELL Uterine Dilator 13" (33 cm), Large Model, with gauge and corrugated blades
- 30-625 GOODELL Uterine Dilator 11" (27.9 cm), Small Model, with gauge and corrugated blades
- 30-650 SIMS Uterine Sound 13" (33 cm), graduated in cm, malleable, silver plated
- 30-655 SIMPSON Uterine Sound 13" (33 cm), graduated in inches, malleable, silver plated
- 7-620 BOZEMAN Uterine Dressing Forceps 10½" (26.7 cm), straight
- 7-622 BOZEMAN Uterine Dressing Forceps 10½" (26.7 cm), double curved, standard model
- 7-624 BOZEMAN Uterine Dressing Forceps 10½" (26.7 cm), double curved, with one large finger ring
- 30-835 CHERON Uterine Dressing Forceps 10½" (26.7 cm), rings angled sideways, serrated jaws 8 x 25 mm



7-624



30-835

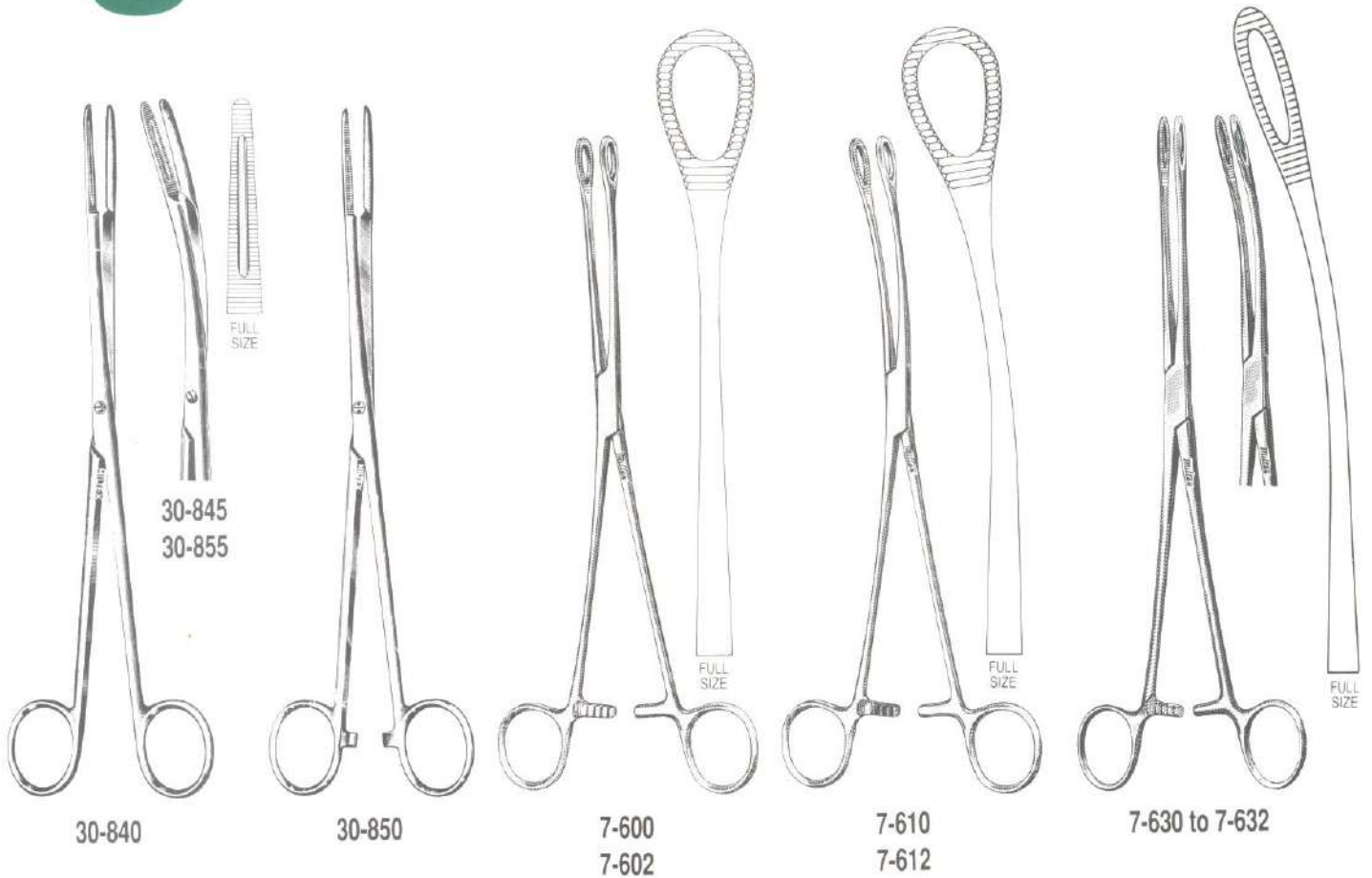

MAIER UTERINE DRESSING FORCEPS 10" (25.4 cm)
Serrated Jaws 5 x 30 mm

Without Ratchet		With Ratchet
30-840	Straight	30-850
30-845	Curved	30-855

- 7-600** FOERSTER Sponge Forceps 9½" (24.1 cm), straight, serrated jaws
- 7-602** FOERSTER Sponge Forceps 9½" (24.1 cm), straight, smooth jaws
- 7-610** FOERSTER Sponge Forceps 9½" (24.1 cm), curved, serrated jaws
- 7-612** FOERSTER Sponge Forceps 9½" (24.1 cm), curved, smooth jaws
- 7-630** FLETCHER Cervix Holding Forceps 9½" (24.1 cm), straight, serrated jaws
- 7-632** FLETCHER Cervix Holding Forceps 9½" (24.1 cm), curved, serrated jaws
(This instrument can also be used as a polyp forceps.)
- V930-996** VANTAGE Polyp Forceps 10½" (26.7 cm), angled shanks, delicate narrow jaws

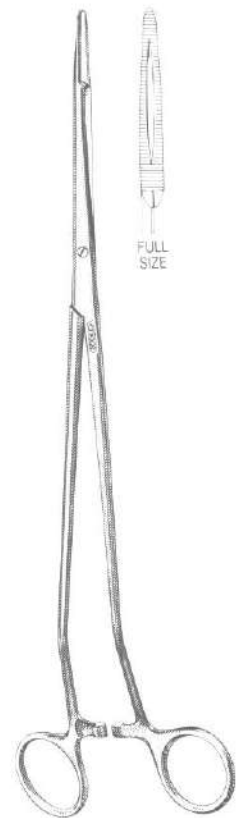

V930-996



30-940



30-950

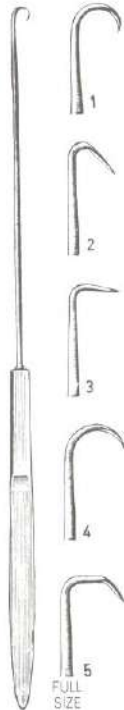

30-951 to 30-955



30-965



30-970

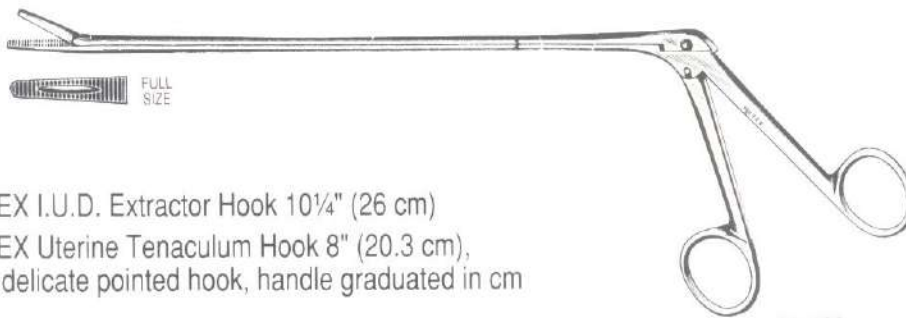

29-102

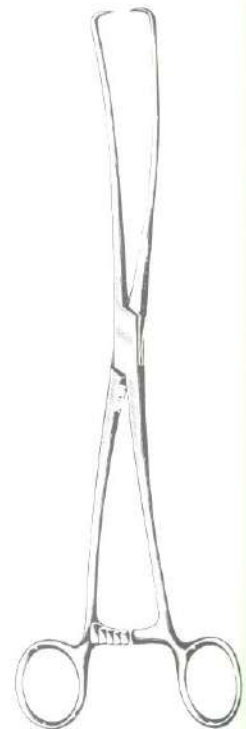

30-975

30-940

MILTEX I.U.D. Extractor Hook 10 $\frac{1}{4}$ " (26 cm)

30-950

MILTEX Uterine Tenaculum Hook 8" (20.3 cm), extra delicate pointed hook, handle graduated in cm

EMMETT UTERINE TENACULUM HOOKS

9" (22.9 cm), Sharp Points

30-951

Style 1 Half-Curved, small

30-954

Style 4 Half-Curved, large

30-952

Style 2 Acute Angle

30-955

Style 5 Double Angle

30-953

Style 3 Right Angle

30-965

SCHROEDER-BRAUN Uterine Tenaculum Forceps 9 $\frac{3}{4}$ " (24.8 cm), straight

30-970

KAHN Uterine Tenaculum Forceps 9 $\frac{1}{2}$ " (24.1 cm), angled jaws and bent shanks

29-102

MATHIEU I.U.D. Removal Forceps 11 $\frac{1}{2}$ " (29.2 cm) shaft, serrated jaws 3.5 mm x 17 mm

30-975

DUPLAY Uterine Tenaculum Forceps 11" (27.9 cm), double curved



16-51



28-200



30-985

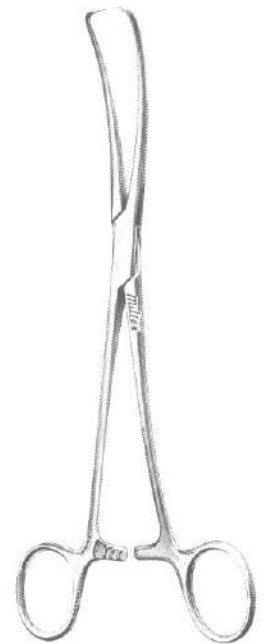

30-988

- 16-51** ADAIR Breast or Uterine Tenaculum Forceps
6½" (16.5 cm), straight
- 28-200** STAUDE-MOORE (FERGUSON) Tenaculum Forceps
6¾" (17.1 cm), straight
- 30-985** BARRETT Uterine Tenaculum Forceps 7¼" (18.4 cm), straight
- 30-988** JARCHO Uterine Tenaculum Forceps 8" (20.3 cm),
double curved
- 30-990** SKENE Uterine Tenaculum Forceps 9½" (24.1 cm),
curved on side
- V930-856** VANTAGE Atraumatic Tenaculum Forceps 9" (22.9 cm),
straight, ¼" (.64 cm) jaws



30-990

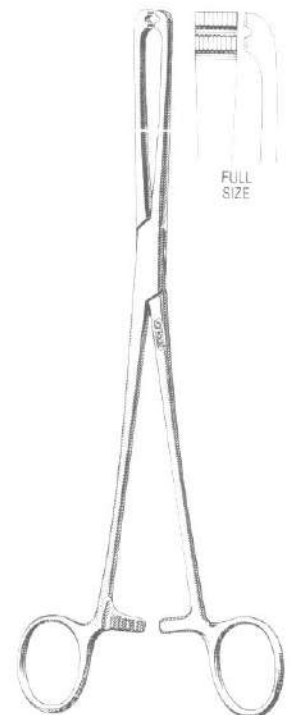

V930-856

FULL
SIZE

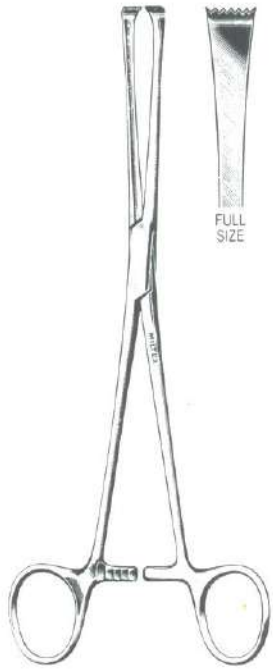

16-38



30-997



30-998



30-1000

16-38 THOMS-ALLIS Vulsellum Forceps 8" (20.3 cm), 6 x 7 teeth

30-997 TEALE Vulsellum Forceps 10" (25.4 cm), curved sideways, 3 x 4 teeth, 5 mm wide

30-998 KELLY Vulsellum Forceps 9 1/4" (23.5 cm), curved sideways, 4 x 5 teeth, 7.7 mm wide

30-1000 SCHROEDER Uterine Vulsellum Forceps 10" (25.4 cm), straight

30-1005 SCHROEDER Uterine Vulsellum Forceps 10" (25.4 cm), curved on flat

30-1010 SCHROEDER Uterine Vulsellum Forceps 10" (25.4 cm), curved sideways



30-1005



30-1010



30-1020



30-1025



30-1030



30-1050



12-80

30-1020 SKENE Uterine Vulsellum Forceps 9½" (24.1 cm), curved sideways

30-1025 JACOBS Uterine Vulsellum Forceps 8½" (21.6 cm), straight, serrated jaws 2 x 2 teeth

30-1030 JACOBS Uterine Vulsellum Forceps 8½" (21.6 cm), curved sideways, serrated jaws 2 x 2 teeth

MUSEUX UTERINE VULSELLUM FORCEPS
9½" (24.1 cm), 2 x 2 teeth

Straight	Jaw Width
30-1050-6	6 mm
30-1050-8	8 mm
30-1050-10	10 mm

12-80 M.G.H. (Lahey) Forceps 6¼" (15.9 cm), 3 x 3 teeth, straight

30-1077 GORDON Uterine Vulsellum Forceps 9" (22.9 cm), straight, heavy pattern, 3 x 3 teeth

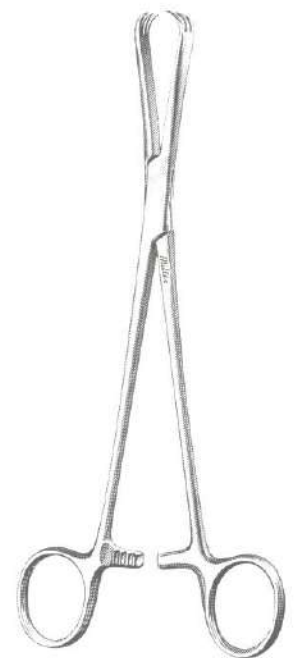

30-1077

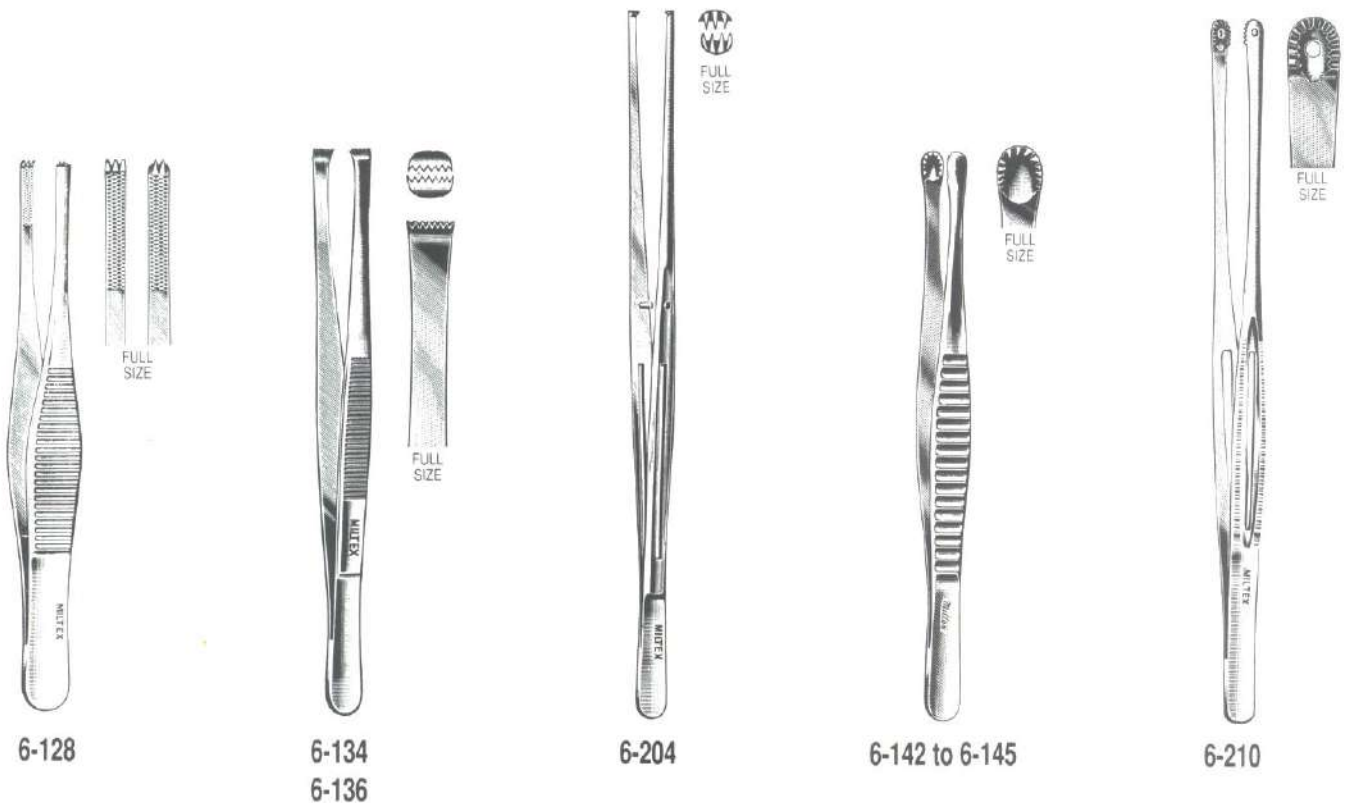

- 6-128 HEANEY Tissue Forceps 5½" (14 cm), broad handles, 2 x 3 teeth and cross serrated tips
- 6-134 MARTIN Tissue Forceps 6" (15.2 cm), 7 x 8 teeth
- 6-136 MARTIN Tissue Forceps 7½" (19.1 cm), 7 x 8 teeth
- 6-204 KELLY Tissue Forceps 9" (22.9 cm), 3 x 4 teeth, slotted serrated handles
- 6-142 RUSSIAN Tissue Forceps 6" (15.2 cm)
- 6-144 RUSSIAN Tissue Forceps 8" (20.3 cm)
- 6-145 RUSSIAN Tissue Forceps 10" (25.4 cm)
- 6-210 MAYO-RUSSIAN Tissue Forceps 9" (22.9 cm), fenestrated jaws, slotted grooved handles



30-1150

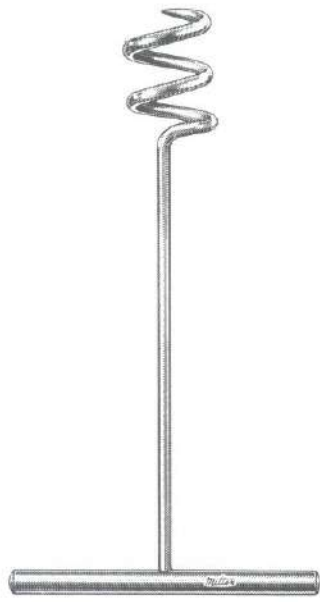

30-1160

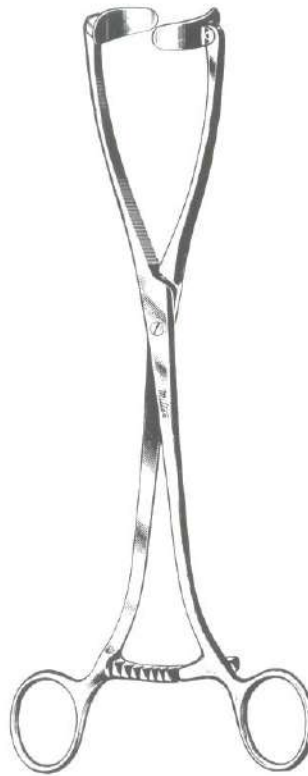

30-1185



30-1190

- 30-1150 BILLROTH Tumor Forceps 11" (27.9 cm), 4 x 4 prongs
- 30-1160 DOYEN Tumor Screw 6¾" (17.1 cm), screw diameter 1" (2.5 cm)
- 30-1185 COLLIN (BUXTON) Uterine Forceps 10½" (26.7 cm), swivel jaws
- 30-1190 SOMER Uterine Elevating Forceps 9" (22.9 cm), curved jaws

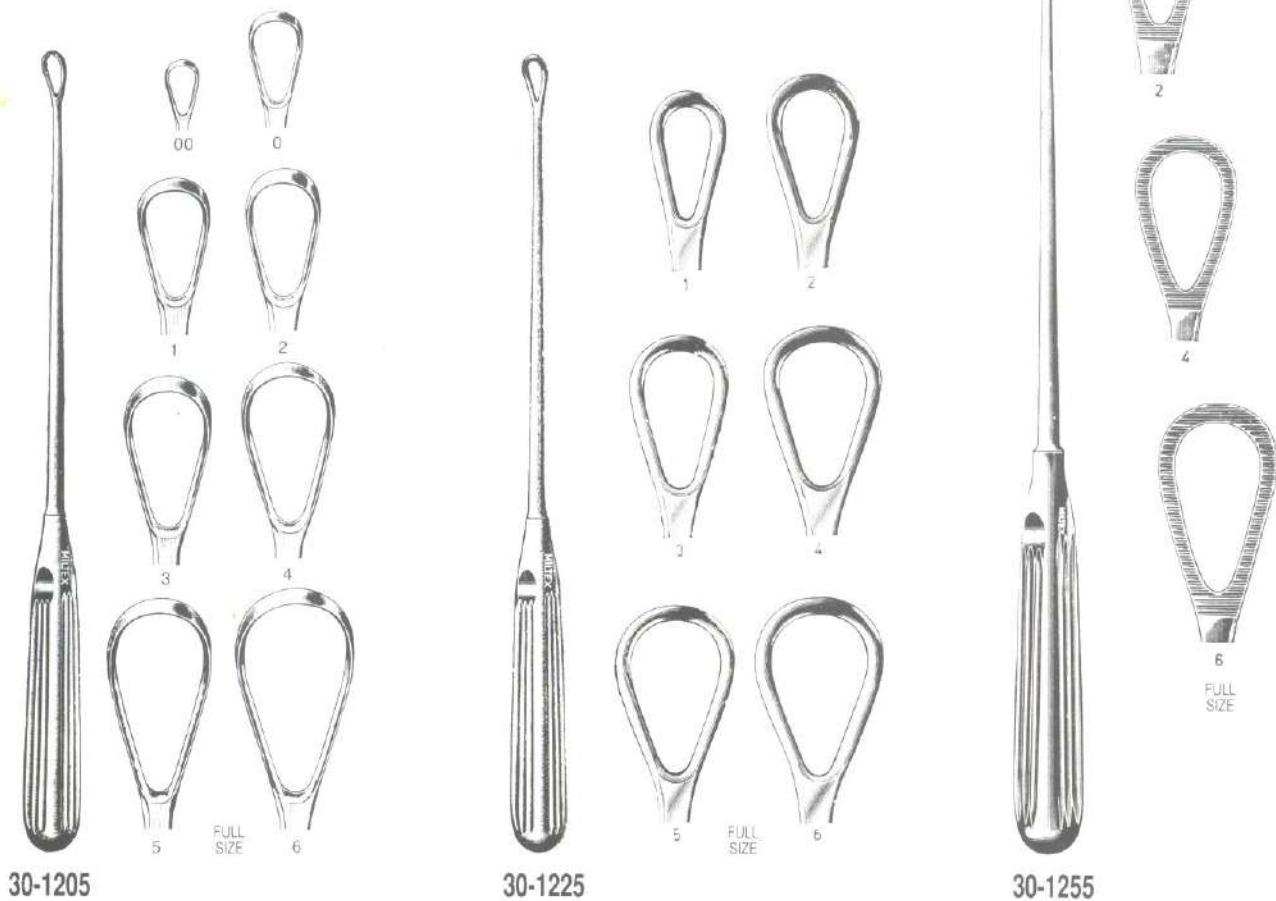

SIMS UTERINE CURETTES 11" (27.9 cm), Sharp Blades on Malleable Shanks

30-1205-00	Size 00	30-1205-3	Size 3
30-1205-0	Size 0	30-1205-4	Size 4
30-1205-1	Size 1	30-1205-5	Size 5
30-1205-2	Size 2	30-1205-6	Size 6

THOMAS UTERINE CURETTES 11" (27.9 cm), Blunt Blades on Malleable Shanks

30-1225-1	Size 1	30-1225-4	Size 4
30-1225-2	Size 2	30-1225-5	Size 5
30-1225-3	Size 3	30-1225-6	Size 6

- 30-1255-2** GREENE Uterine Curette 11" (27.9 cm), Serrated Blunt Blade on Malleable Shank, Size 2
- 30-1255-4** GREENE Uterine Curette 11" (27.9 cm), Serrated Blunt Blade on Malleable Shank, Size 4
- 30-1255-6** GREENE Uterine Curette 11" (27.9 cm), Serrated Blunt Blade on Malleable Shank, Size 6

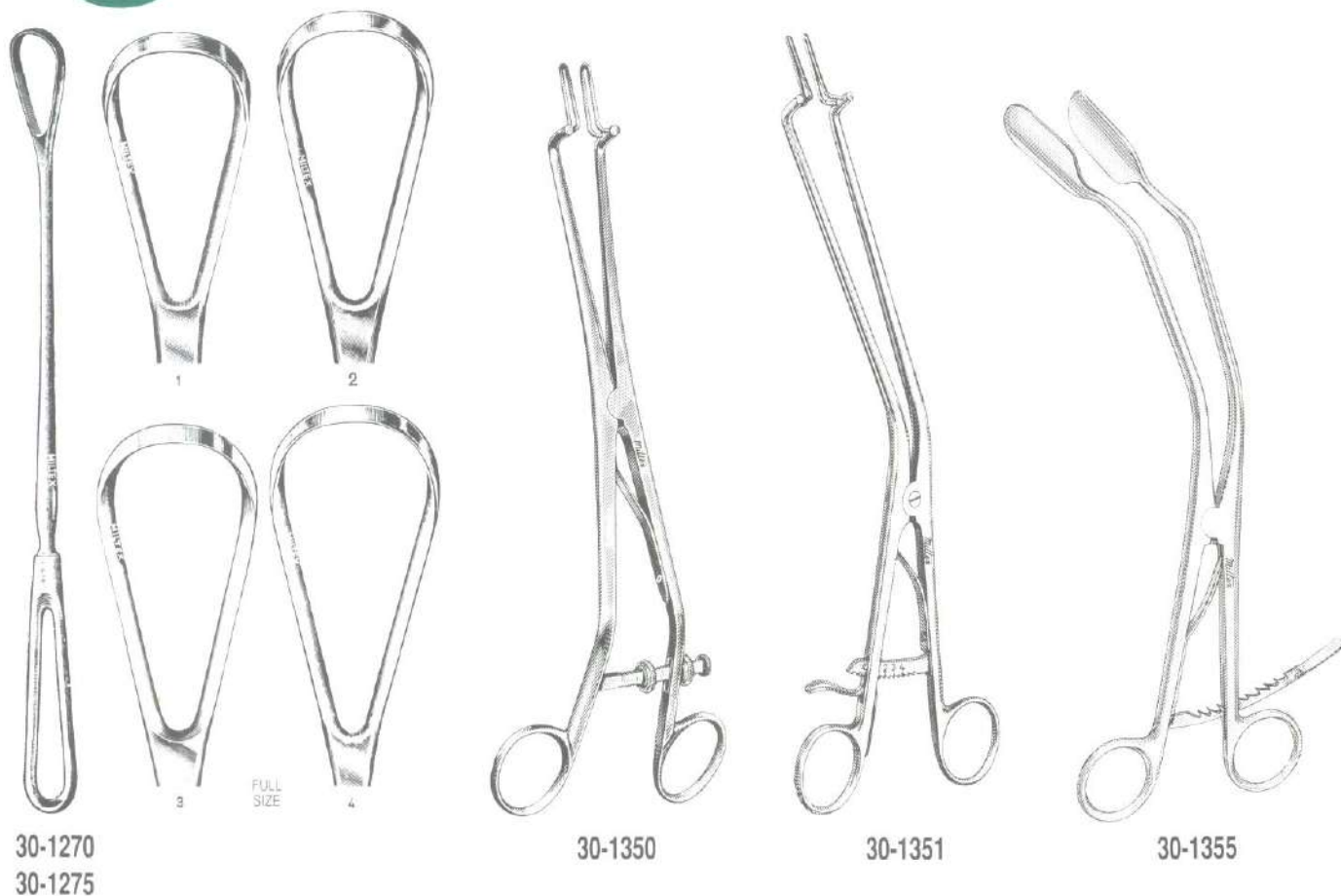

BUMM UTERINE CURETTES 12" (30.5 cm), Extra Large Sizes on Malleable Shanks

Sharp	Size	Blunt
30-1270-1	1	30-1275-1
30-1270-2	2	—
30-1270-3	3	—
30-1270-4	4	30-1275-4

- 30-1350** KOGAN Endocervical Speculum 9½" (24.1 cm), with gauge and set screw, offset ring handles, fenestrated jaws 7 x 25 mm
- 30-1351** MILTEX-KOGAN Endocervical Speculum 11" (27.9 cm), improved pattern with ratchet and gauge. Extra delicate fenestrated jaws 3 mm wide at tip x 25 mm long
- 30-1355** Lateral Vaginal Retractor 8¼" (21 cm) with extra long thumb ratchet retracts up to a full 2¼" (5.7 cm) for an extra wide viewing area.



- 30-1380** SIMS Uterine Biopsy Curette 10" (25.4 cm), extra small sharp loop, outside meas. 2.5 x 5 mm
- 30-1382** KEVORKIAN-YOUNGE Endocervical Biopsy Curette 12" (30.5 cm), loop size 3 x 12 mm, with basket
- 30-1383** KEVORKIAN-YOUNGE Endocervical Biopsy Curette 12" (30.5 cm), loop size 3 x 12 mm, without basket
- 30-1385** HEANEY Uterine Biopsy Curette 9" (22.9 cm), serrated loop
- 30-1390** NOVAK Endometrial Suction Biopsy Curette 9¾" (24.8 cm), with Luer hub, 4 mm dia., standard 12 Fr. size
- 30-1391** NOVAK Endometrial Suction Biopsy Curette 9¾" (24.8 cm), with Luer hub, 2 mm dia., extra delicate
- 30-1392** NOVAK Endometrial Suction Biopsy Curette 9¾" (24.8 cm), with Luer hub, 3 mm dia., delicate
- 30-1395** RANDALL Endometrial Suction Biopsy Curette 9¾" (24.8 cm), with Luer hub, 4 mm dia.



30-1400



30-1405
30-1410

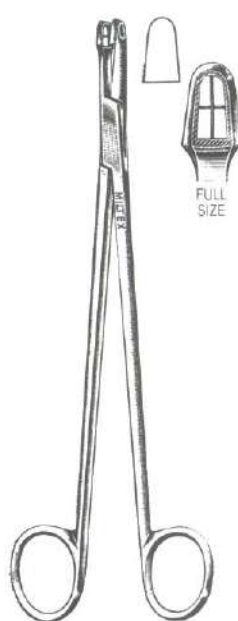

30-1420



30-1425

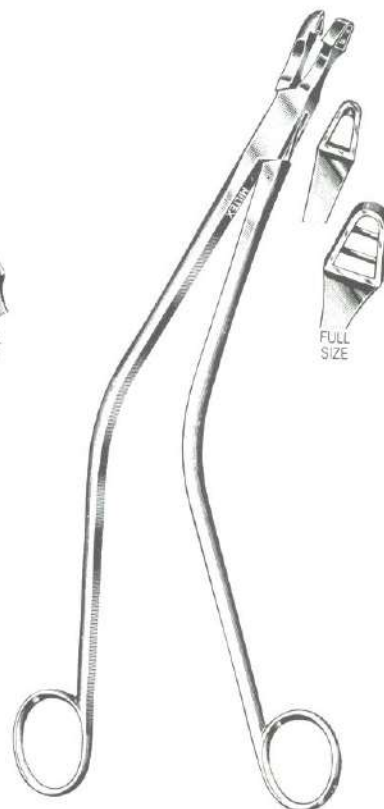

30-1430

30-1400 GAYLOR Uterine Biopsy Forceps 8½" (21.6 cm), straight shanks, curved jaws, 5 mm bite, interfitted cups

30-1405 THOMS-GAYLOR Uterine Biopsy Forceps 8½" (21.6 cm), angled shanks, curved jaws, 5 mm bite, interfitted cups

30-1410 THOMS-GAYLOR Uterine Biopsy Forceps 9½" (24.1 cm), angled shanks, curved jaws, 5 mm bite, interfitted cups

30-1420 SCHUBERT Uterine Biopsy Forceps 8½" (21.6 cm), straight

30-1425 SCHUBERT Uterine Biopsy Forceps 8½" (21.6 cm), curved

30-1430 SCHUBERT Uterine Biopsy Forceps 11" (27.9 cm), angled shanks

30-1435 SCHUBERT Uterine Biopsy Forceps 11" (27.9 cm), S-shape, triangular bite

30-1440 GELLHORN Uterine Biopsy Forceps 9½" (24.1 cm), curved, oval bite, 5 x 8 mm



30-1435



30-1440

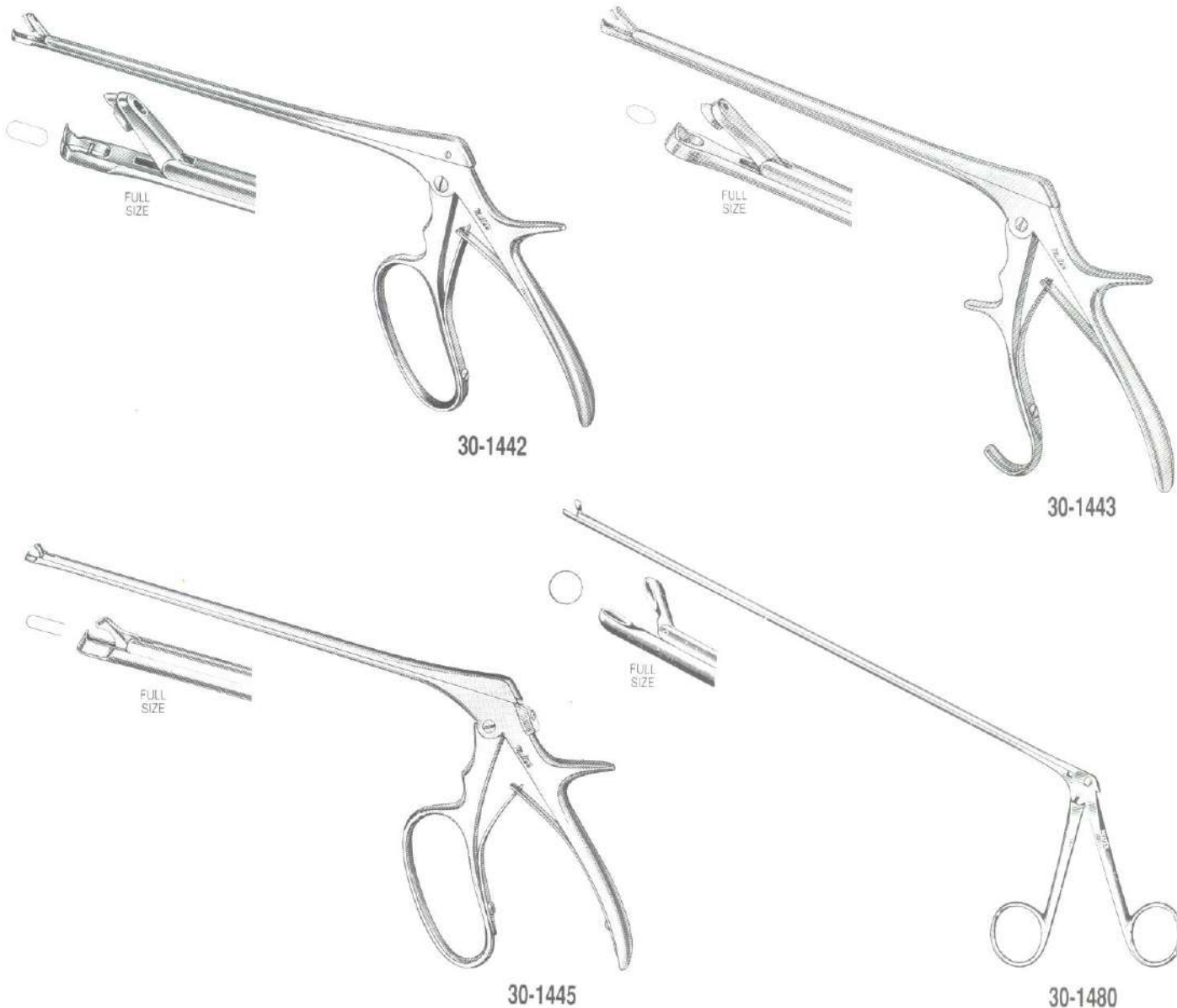

- 30-1442** TISCHLER Cervical Biopsy Punch Forceps 9 $\frac{3}{4}$ " (24.8 cm) shaft, 6 x 3 x 1/5 mm bite
- 30-1443** BURKE (Modified Baby TISCHLER) Cervical Biopsy Punch Forceps 7 $\frac{3}{4}$ " (19.7 cm) shaft, 4.5 x 3 x 1.5 mm bite
- 30-1445** TOWNSEND 'Mini-bite' Cervical Biopsy Punch Forceps 7 $\frac{1}{2}$ " (19.1 cm) shaft, 4.2 x 2.3 x 1 mm bite with locking mechanism
- 30-1480** MILTEX Cup Jaw Uterine Biopsy Forceps 9" (22.9 cm) shaft, plain not interfitted cups, 6 mm bite

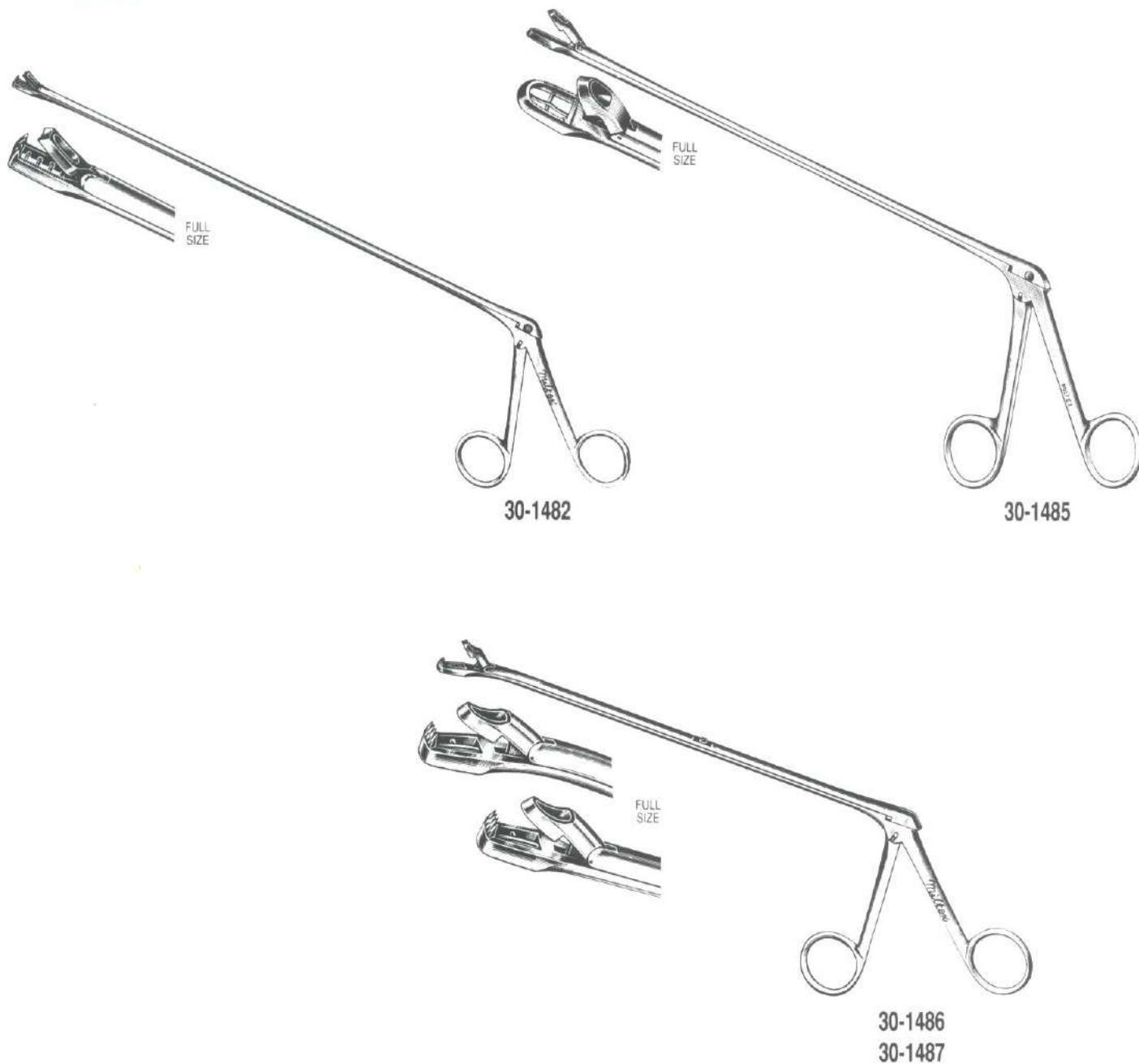

- 30-1482** KEVORKIAN-YOUNGE Uterine Biopsy Forceps
9½" (24.1 cm) shaft, 3.5 x 8 mm bite, teeth on lower jaw
- 30-1485** EPPENDORFER Uterine Biopsy Forceps, 8½" (21.6 cm) shaft
- 30-1486** WITTNER Uterine Biopsy Forceps 8½" (21.6 cm) shaft, with teeth on lower jaw, standard model with angled tip
- 30-1487** WITTNER Uterine Biopsy Forceps 8½" (21.6 cm) shaft, with teeth on lower jaw, straight tip

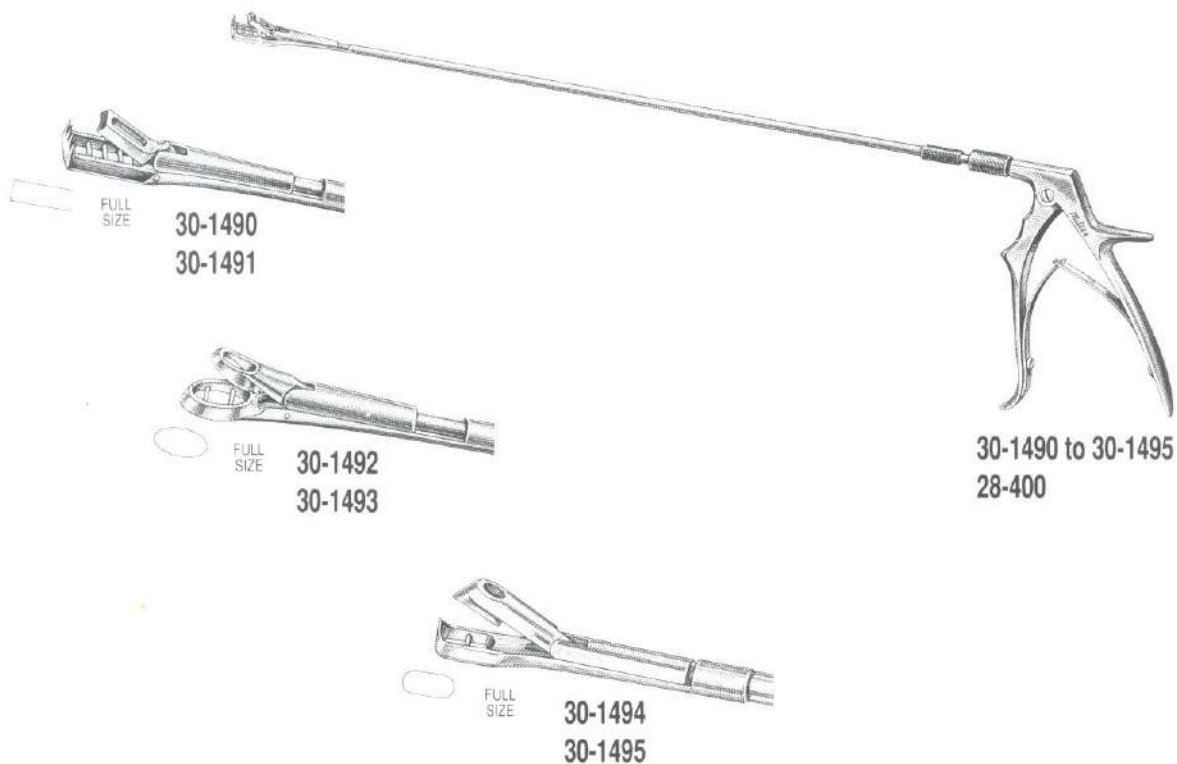

MILTEX ROTATING SHAFT UTERINE BIOPSY FORCEPS
9" (22.9 cm) shafts are interchangeable on Pistol Grip Spring Handles

- 30-1490** KEVORKIAN-YOUNGE Biopsy Forceps, 3.5 x 8 mm bite, teeth on lower jaw, complete with Pistol Grip Handle
- 30-1491** KEVORKIAN-YOUNGE Biopsy Forceps, Shaft only
- 30-1492** EPPENDORFER-KRAUSE Biopsy Forceps, oval 4.5 x 6.5 mm bite, complete with Pistol Grip Handle
- 30-1493** EPPENDORFER-KRAUSE Biopsy Forceps, Shaft only
- 30-1494** TISCHLER Biopsy Forceps, 3 x 7 mm bite, complete with Pistol Grip Handle
- 30-1495** TISCHLER Biopsy Forceps, Shaft only
- 28-400** Pistol Grip Spring Handle fitting all Miltex Rotating Shaft Uterine Biopsy Forceps (this handle also fits Rectal Biopsy Punches Nos. 28-380 to 28-416)



30-1700

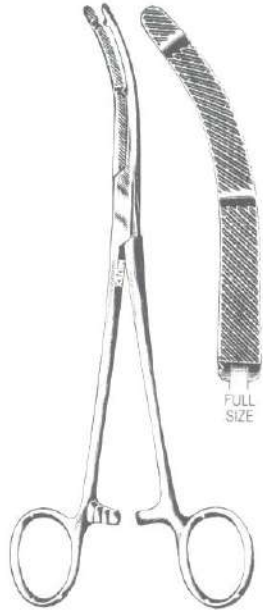

30-1710
30-1715

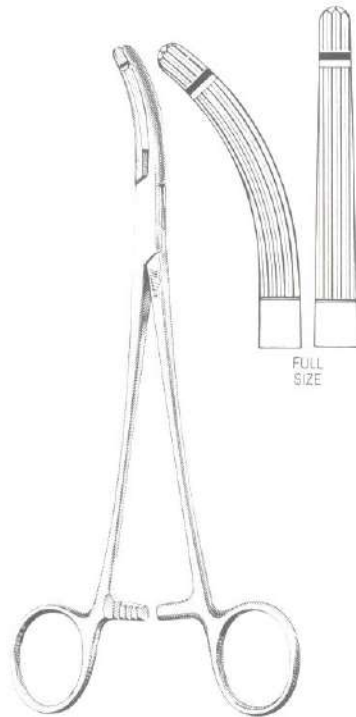

30-1716
30-1718

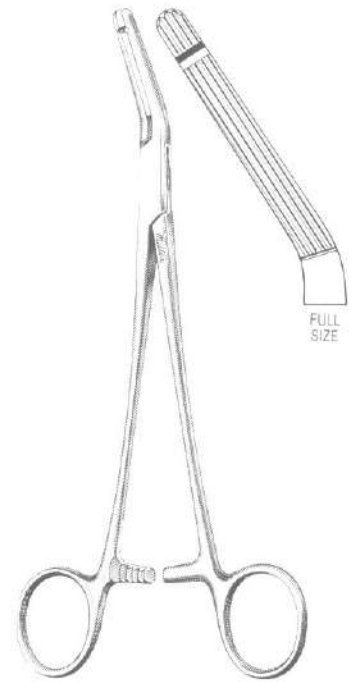

30-1720

- 30-1700 HEANEY Hysterectomy Forceps 8 $\frac{1}{4}$ " (21 cm), heavy pattern, single tooth, curved
- 30-1710 HEANEY Hysterectomy Forceps 8 $\frac{1}{4}$ " (21 cm), heavy pattern, double tooth, curved
- 30-1715 HEANEY Hysterectomy Forceps 9 $\frac{3}{4}$ " (24.8 cm), extra heavy pattern, double tooth, curved
- 30-1716 HEANEY-BALLENTINE Hysterectomy Forceps 8 $\frac{1}{2}$ " (21 cm), longitudinal serrations, single tooth, curved
- 30-1718 BALLENTINE Hysterectomy Forceps 8 $\frac{1}{2}$ " (21.6 cm), longitudinal serrations, single tooth, straight
- 30-1720 GARLAND Hysterectomy Forceps 8 $\frac{1}{2}$ " (21 cm), longitudinal serrations, single tooth, angled on flat



30-1730



30-1735



30-1740



7-124 to 7-148

30-1730 LONG Hysterectomy Forceps 7½" (19.1 cm), longitudinal serrations, 1 x 2 teeth, curved

30-1735 PHANEUF Uterine Artery Forceps 8" (20.3 cm), horizontal serrated jaws, 1 x 2 teeth, straight

30-1740 PHANEUF Uterine Artery Forceps 8" (20.3 cm), horizontal serrated jaws, 1 x 2 teeth, angled on flat

PEAN HYSTERECTOMY FORCEPS, with Horizontal Serrations

Straight	Size	Curved
7-124	8" (20.3 cm)	7-142
7-126	9" (22.9 cm)	7-144
7-128	10¼" (26 cm)	7-146
7-130	12" (30.5 cm)	7-148

30-1805 PEAN Hysterectomy Forceps 9" (22.9 cm), curved, with longitudinal serrations

30-1815 PEAN Hysterectomy Forceps 10¼" (26 cm), curved, with longitudinal serrations

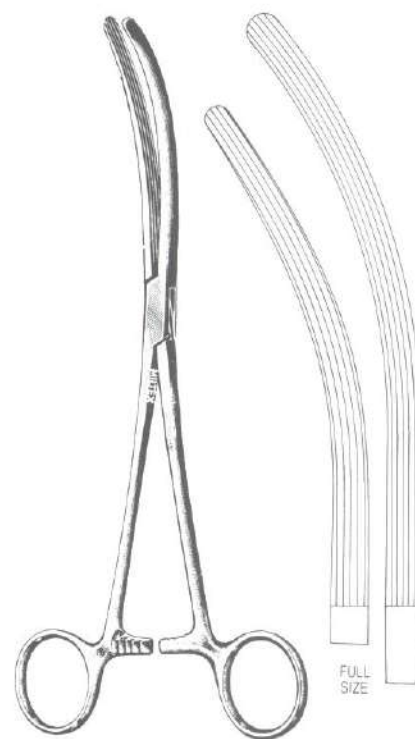

30-1805
30-1815



7-190



29-280



29-282

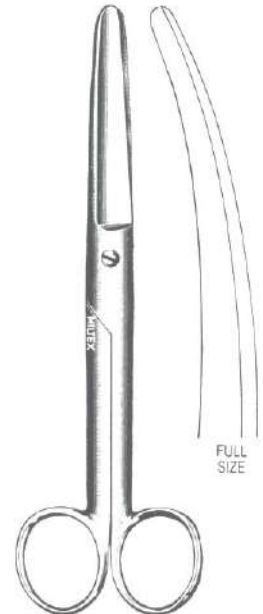

5-160
5-162

- 7-190 MICULICZ Peritoneal Clamp 8" (20.3 cm), curved, 1 x 2 teeth
- 29-280 WERTHEIM Vaginal Forceps 9¾" (24.8 cm), curved, 2" (5.1 cm) jaws
- 29-282 WERTHEIM-CULLEN Pedicle Forceps 8½" (21.6 cm), right angle 2" (5.1 cm) jaws
- 5-160 DOYEN Scissors 7" (17.8 cm), straight, heavy pattern
- 5-162 DOYEN Scissors 7" (17.8 cm), curved, heavy pattern
- 5-166 FERGUSON Scissors 7" (17.8 cm), angled on flat



5-166

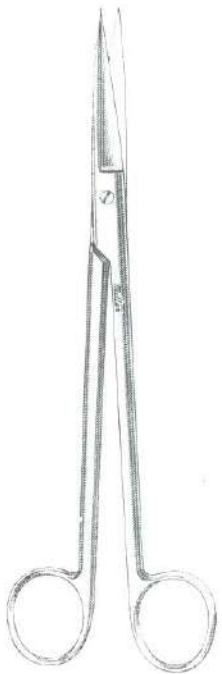

5-220 to 5-224

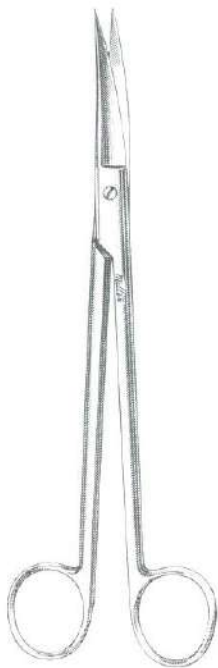

5-226 to 5-230



5-250
5-252



5D-251

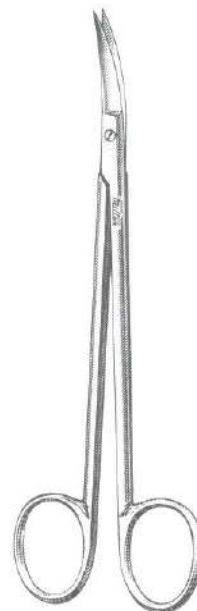

5D-253

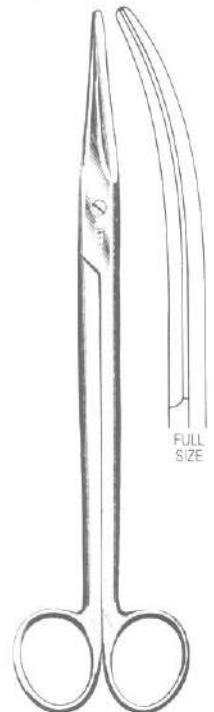

5-128
5-130

SIMS UTERINE SCISSORS 8" (20.3 cm)

Straight	Points	Curved
5-220	Sharp-Sharp	5-226
5-222	Sharp-Blunt	5-228
5-224	Blunt-Blunt	5-230

5-250 KELLY Uterine Scissors 6¼" (15.9 cm), sharp points, straight
5D-251 KELLY Uterine Scissors 6¼" (15.9 cm), sharp points, straight, with one serrated blade

5-252 KELLY Uterine Scissors 6¼" (15.9 cm), sharp points, curved
5D-253 KELLY Uterine Scissors 6¼" (15.9 cm), sharp points, curved, with one serrated blade

5-128 MAYO Uterine Scissors 9" (22.9 cm), straight
5-130 MAYO Uterine Scissors 9" (22.9 cm), curved

5-186 NELSON Uterine Scissors 9" (22.9 cm), straight
5-188 NELSON Uterine Scissors 9" (22.9 cm), curved

30-2190 BRAUN Episiotomy Scissors 5½" (14 cm), angled to side, guarded lower blade

30-2195 BRAUN Episiotomy Scissors 8¼" (21.6 cm), angled to side, guarded lower blade



5-186
5-188



30-2190
30-2195

For Carb-N-Sert Scissors with Tungsten Carbide inserts and Super Cut Scissors – see pages 55-63.



30-2200



30-2205



30-2210



30-2230

30-2200 PINARD Fetal Heart Stethoscope, aluminum

30-2205 DE LEE-HILLIS Obstetrical Stethoscope with padded head support, rigid metal arm. Complete with binaurals, chrome

30-2210 DE LEE Obstetrical Stethoscope, same as No. 30-2205 but with flexible arm, chrome

30-2230 MARTIN Pelvimeter, graduated in centimeters and inches

30-2235 COLLYER Pelvimeter, graduated in centimeters and inches



30-2235



30-2250



30-2260



30-2300



30-2305

- 30-2250 IOWA Membrane Puncturing Forceps 10¼" (26 cm), double curved, 6 x 6 teeth
- 30-2260 BEACHAM Amniotome 10¼" (26 cm)
- 30-2300 SIMPSON Obstetrical Forceps, Long Model, 14" (35.6 cm)
- 30-2305 SIMPSON Obstetrical Forceps, Short Model, 12" (30.5 cm)



30-2315



30-2320



30-2330

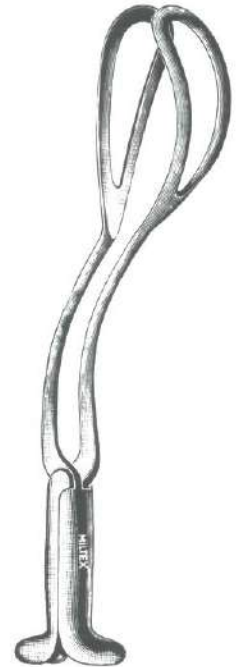

30-2335

- 30-2315 DE LEE Obstetrical Forceps, Standard Model, 14" (35.6 cm)
- 30-2320 DE LEE Obstetrical Forceps, Short Model, 12" (30.5 cm)
- 30-2330 ELLIOTT Obstetrical Forceps, Short Model, 12½" (31.8 cm)
- 30-2335 PIPER Obstetrical Forceps 17½" (44.5 cm)
- 30-2345 BILL Traction Handle, for use with any O.B. Forceps having standard type handle

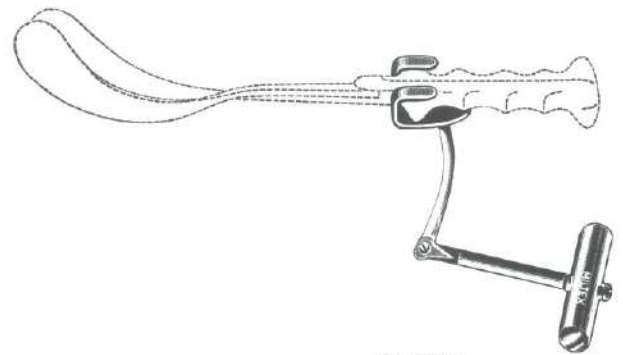

30-2345



30-2350



30-2355



30-2390



30-2400

- 30-2350 KIELLAND Obstetrical Forceps 15½" (39.4 cm)
- 30-2355 KIELLAND-LUIKART Obstetrical Forceps 15½" (39.4 cm), solid blades
- 30-2390 LUIKART Obstetrical Forceps 15½" (39.4 cm), solid blades
- 30-2400 SIMPSON-LUIKART Obstetrical Forceps 14" (35.6 cm), solid blades



30-2410



30-2415

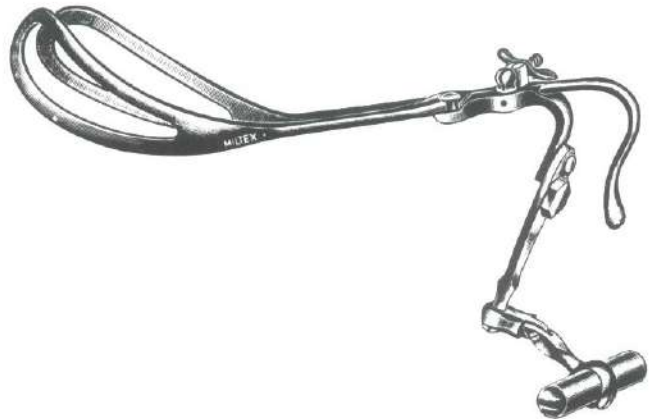

30-2430

- 30-2410 McLEAN-LUIKART Obstetrical Forceps 15¾" (40 cm), solid blades, long shanks
- 30-2415 McLEAN-TUCKER-LUIKART Obstetrical Forceps 15¾" (40 cm), solid blades, long shanks
- 30-2430 DEWEY Obstetrical Forceps 14" (35.6 cm), with Axis Traction

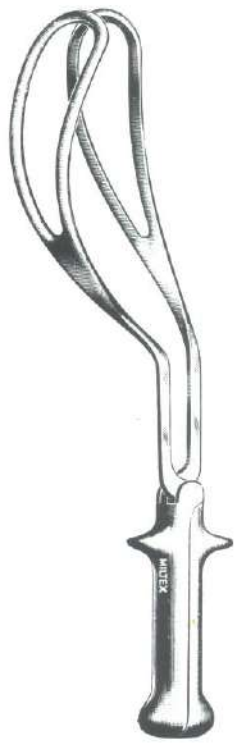

30-2435

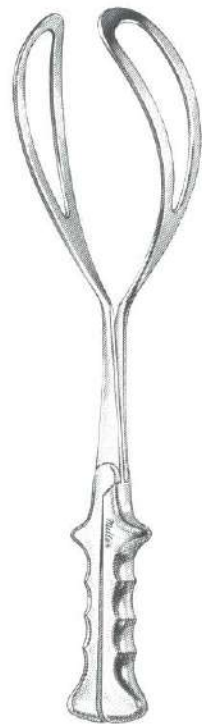

30-2445

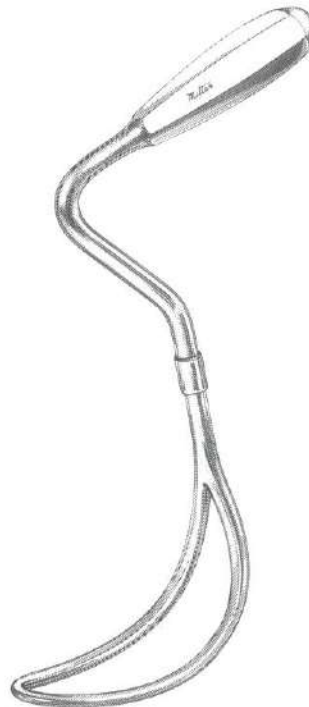

30-2450

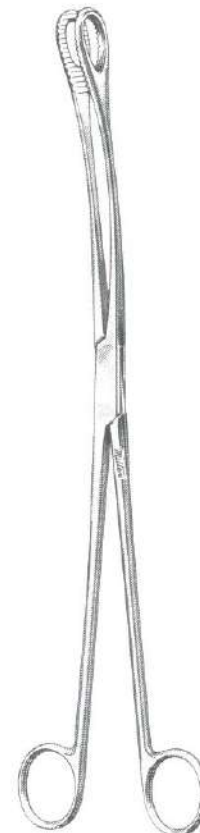

30-2505

- 30-2435 HAWKS-DENNEN Obstetrical Forceps 15" (38.1 cm)
- 30-2445 BAILEY-WILLIAMSON Obstetrical Forceps 15½" (39.4 cm)
- 30-2450 MURLESS Head Extractor 10" (25.4 cm), with hinged shaft and sliding collar lock
- 30-2505 KELLY Placenta Forceps 12½" (31.8 cm), serrated ring jaws, slightly curved



30-2530
30-2535



30-2560



30-2575



30-2580

- 30-2530 WINTER Placenta Forceps 11" (27.9 cm), cup jaws, straight
- 30-2535 WINTER Placenta Forceps 11" (27.9 cm), cup jaws, curved
- 30-2560 KANE Umbilical Clamp 3½" (8.9 cm)
- 30-2575 Umbilical Scissors 4⅞" (10.5 cm), American Pattern
- 30-2580 BUSCH Umbilical Scissors 6½" (16.5 cm), curved on side
- 30-2605 DUBOIS Decapitation Scissors 10½" (26.7 cm), curved, extra heavy pattern, blunt points
- 30-2632 IOWA Trumpet Pudendal Needle Guide 5½" (14 cm)

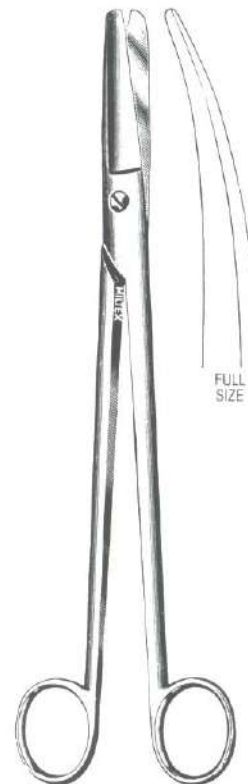

30-2605

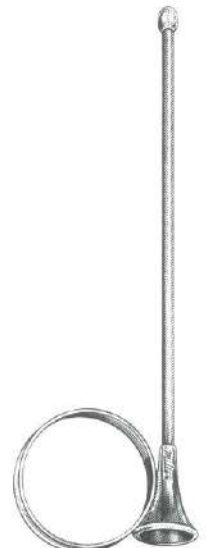

30-2632



33-2 to 33-5B



33-6 to 33-11A



33-16-00 to 33-16-3



33-12 to 33-15



40-54

FOX DERMAL CURETTES 5½" (14 cm), Round

33-2	6 mm dia.	33-5	3 mm dia.
33-3	5 mm dia.	33-5A	2 mm dia.
33-4	4 mm dia.	33-5B	1 mm dia.

PIFFARD DERMAL CURETTES 6¼" (15.9 cm), Oval

33-6	Size 1 (3 mm dia.)	33-11	Size 4 (8 mm dia.)
33-8	Size 2 (5 mm dia.)	33-11A	Size 5 (10 mm dia.)
33-10	Size 3 (6 mm dia.)		

PIFFARD DERMAL CURETTES 5½" (14 cm), oval, narrow handles

33-16-00	Size 00 (1 mm dia.)	33-16-2	Size 2 (5 mm dia.)
33-16-0	Size 0 (1.5 mm dia.)	33-16-3	Size 3 (6 mm dia.)
33-16-1	Size 1 (3 mm dia.)		

33-12	MILTEX Dermal Curette 6¼" (15.9 cm), oval spoon size 0 (3 mm dia.)
33-13	MILTEX Dermal Curette 6¼" (15.9 cm), oval spoon size 1 (4 mm dia.)
33-14	MILTEX Dermal Curette 6¼" (15.9 cm), oval spoon size 2 (5 mm dia.)
33-15	MILTEX Dermal Curette 6¼" (15.9 cm), oval spoon size 3 (6 mm dia.)

40-54	MILTEX Verucca Curette 5" (12.7 cm), cup 4 mm dia.
-------	--

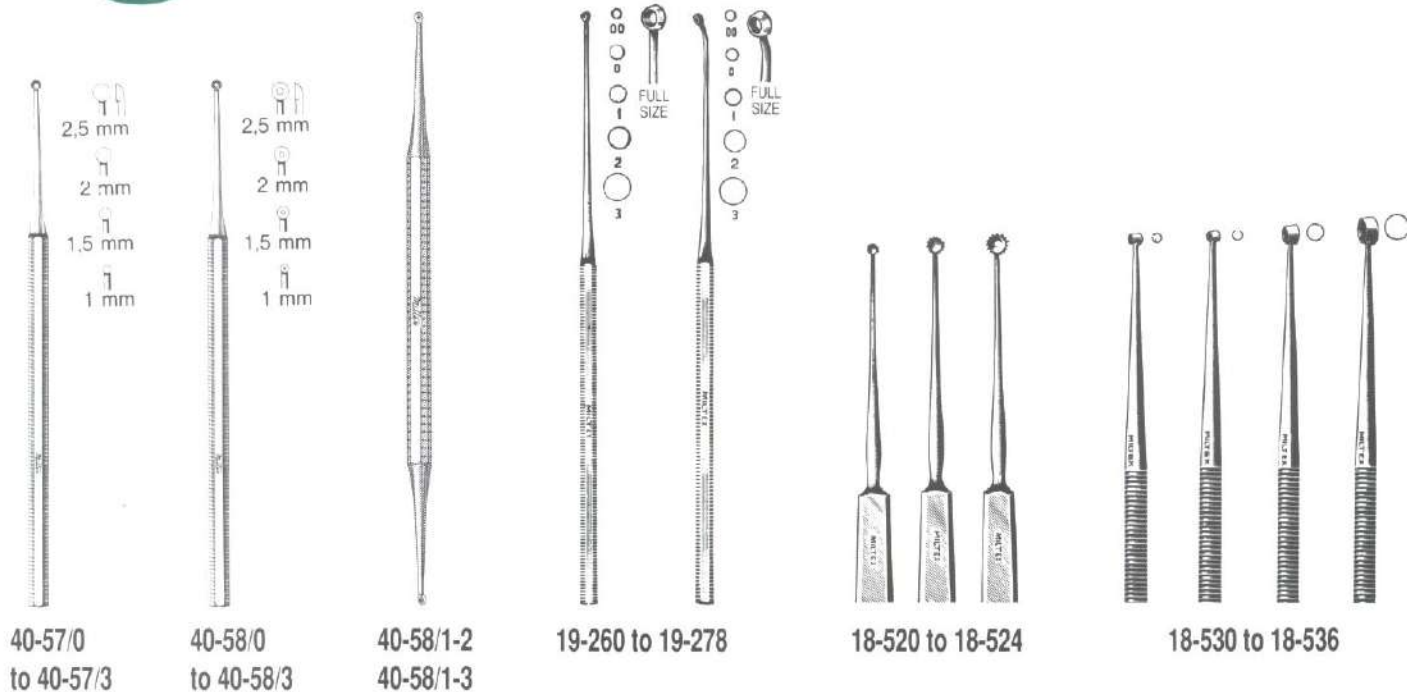

MILTEX EXCAVATOR CURETTES, Single End 5" (12.7 cm)

W/O Hole	Diameter	W/Hole
40-57/0	1 mm	40-58/0
40-57/1	1.5 mm	40-58/1
40-57/2	2 mm	40-58/2
40-57/3	2.5 mm	40-58/3

MILTEX EXCAVATOR CURETTES, Double End 5½" (14 cm)

- 40-58/1-2 Small 1.5 mm and Medium 2 mm dia.
- 40-58/1-3 Small 1.5 mm and Large 2.5 mm dia.

BUCK CURETTES 6½" (16.5 cm), Sharp

Straight	Size	Angled
19-260	00	19-270
19-262	0	19-272
19-264	1	19-274
19-266	2	19-276
19-268	3	19-278

- 18-520 SKEELE Curette 5" (12.7 cm), round 1 mm cup, serrated edge
- 18-522 SKEELE Curette 5" (12.7 cm), round 2 mm cup, serrated edge
- 18-524 SKEELE Curette 5" (12.7 cm), round 2.5 mm cup, serrated edge

- 18-530 HEATH Curette 4" (10.2 cm), Size 0, one sharp and one blunt edge, 0.5 mm
- 18-532 HEATH Curette 4" (10.2 cm), Size 1, one sharp and one blunt edge, 1 mm
- 18-534 HEATH Curette 4" (10.2 cm), Size 2, one sharp and one blunt edge, 2 mm
- 18-536 HEATH Curette 4" (10.2 cm), Size 3, one sharp and one blunt edge, 3 mm



33-20 to 33-28

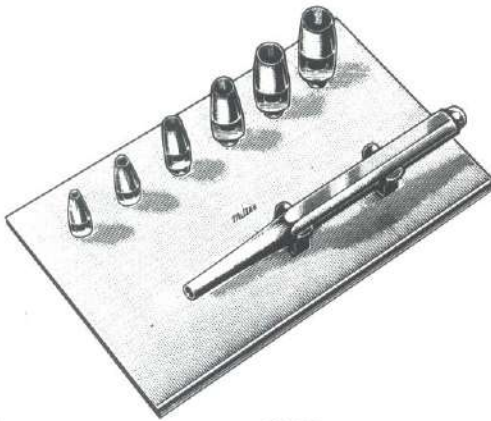

33-30

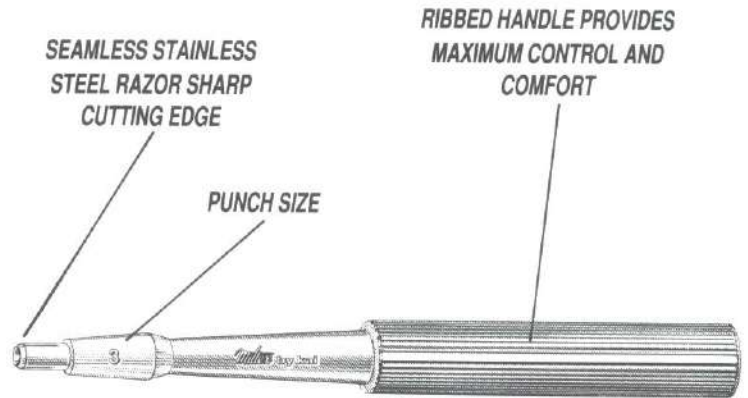

33-31A to 33-37

KEYES DERMAL PUNCHES 4" (10.2 cm)

33-20	2 mm	33-25	5 mm
33-22	3 mm	33-26	6 mm
33-24	4 mm	33-28	8 mm

33-30 KEYES Dermal Punch Set, 3½" (8.9 cm) Handle, with screw-in Keyes Knives 2, 3, 4, 5, 6 and 7 mm mounted on storage and sterilization rack

Replacement Parts for No. 33-30 Punch Set

33-30-1	Handle		
33-30-2	2 mm Head	33-30-5	5 mm Head
33-30-3	3 mm Head	33-30-6	6 mm Head
33-30-4	4 mm Head	33-30-7	7 mm Head



MILTEX Sterile Disposable Biopsy Punches – made by Kai
Each Sterile Biopsy Punch is sealed in a peel-apart see-through package.
Packed 50 Biopsy Punches to a Dispenser Box. Sterilized by EO.

33-31A	1.5 mm	33-34	4 mm
33-31	2 mm	33-35	5 mm
33-32	3 mm	33-36	6 mm
33-33	3.5 mm	33-37	8 mm

FEATURES:

- Seamless stainless steel razor sharp cutting edge
- Ribbed handle provides maximum control and comfort
- Size marked on every punch for easy identification
- Sterile – ready to use every time
- Convenient – use once and discard
- Eliminates need for re-sharpening
- Clean, precise specimens for accurate diagnosis
- Wide range of sizes



33-40



5-300



5-302

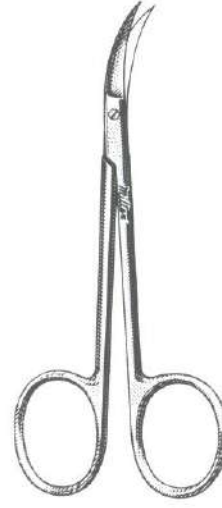

5D-303

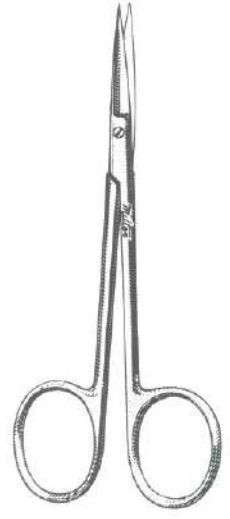

5-304

33-40 VAUGHAN Abscess Knife Set 5" (12.7 cm), one straight 20 mm lancet and one curved 12 mm knife, with protective screw-on caps, and pocket clip

5-300 Iris Scissors 4" (10.2 cm), straight

5-302 Iris Scissors 4" (10.2 cm), curved

5D-303 Iris Scissors 4½" (11.4 cm), curved sideways

5-304 Iris Scissors 4½" (11.4 cm), straight

5-306 Iris Scissors 4½" (11.4 cm), curved

5-308 Iris Scissors 4½" (11.4 cm), curved sideways



5-306



5-308

For Carb-N-Sert Scissors with tungsten carbide inserts and SuperCut Scissors see pages 55 - 63

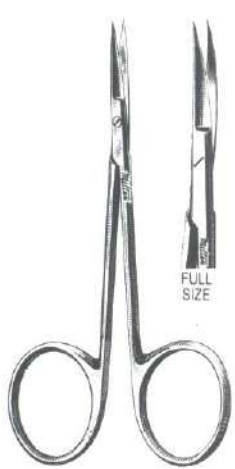

18-1392
18-1394



18-1396



18-1398

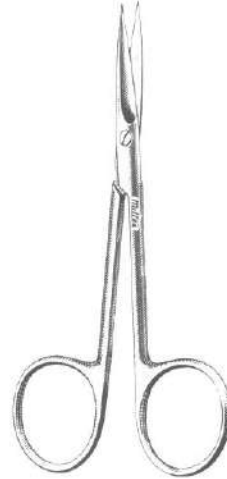

18-1404

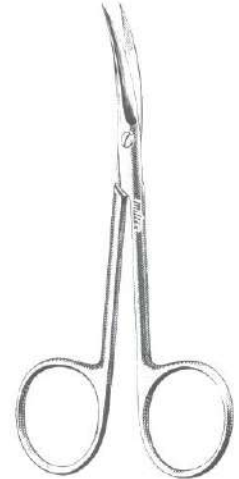

18-1405

- 18-1392 BONN Miniature Iris Scissors 3½" (8.9 cm), with 15 mm blades, straight
- 18-1394 BONN Miniature Iris Scissors 3½" (8.9 cm), with 15 mm blades, curved
- 18-1396 Iris Scissors 3½" (8.9 cm), with 20 mm blades, straight, delicate
- 18-1398 Iris Scissors 3½" (8.9 cm), with 20 mm blades, curved, delicate
- 18-1404 MILTEX Iris Scissors 4" (10.2 cm), straight, heavy pattern
- 18-1405 MILTEX Iris Scissors 4" (10.2 cm), curved, heavy pattern
- 18-1415* Iris Scissors 4" (10.2 cm), straight, standard pattern, ribbon type
- 18-1416* Iris Scissors 4" (10.2 cm), curved, standard pattern, ribbon type
- 18-1417* Iris Scissors 3¾" (9.5 cm), straight, miniature pattern with 14 mm blades, ribbon type
- 18-1418* Iris Scissors 3¾" (9.5 cm), curved, miniature pattern with 14 mm blades, ribbon type

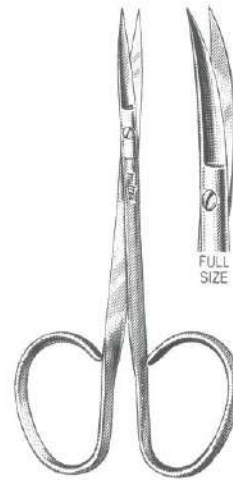

18-1415*
18-1416*



18-1417*
18-1418*

*Ribbon Type Scissors have extra large finger rings; shanks and rings have satin finish; blades are highly polished

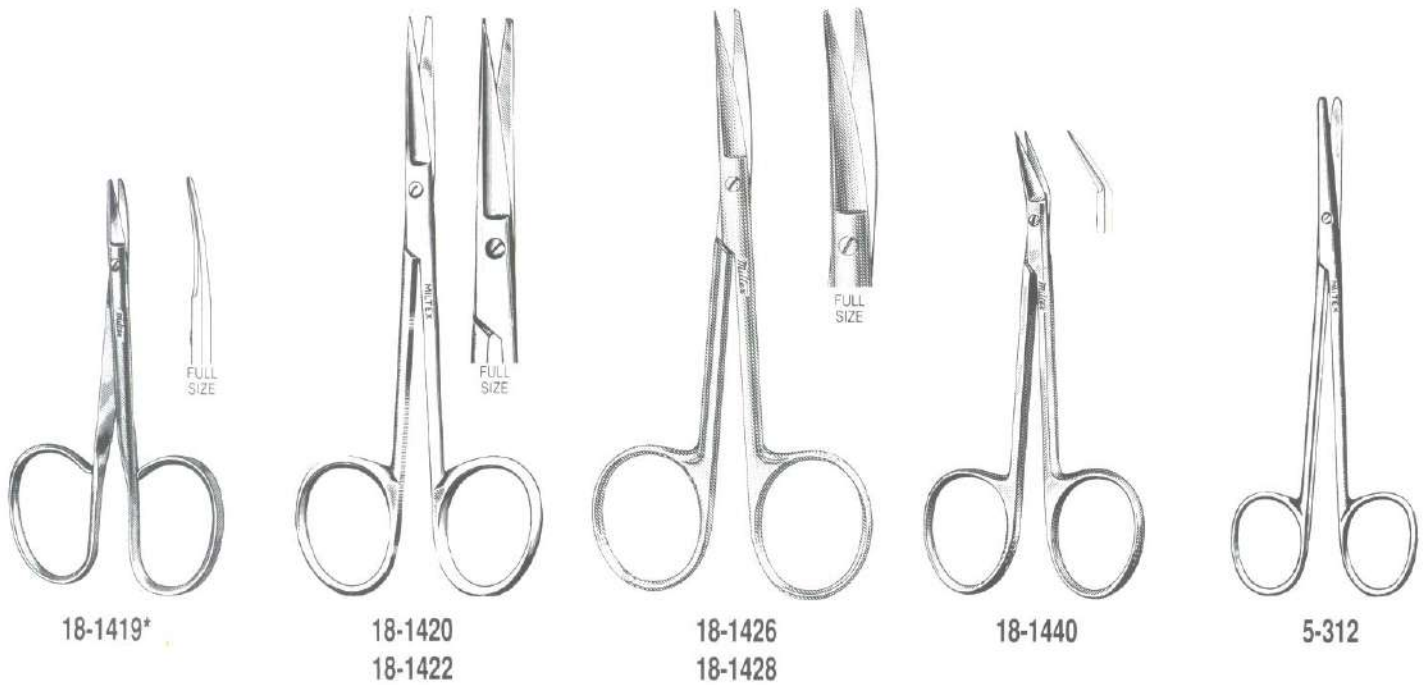

- 18-1419*** Utility Scissors 3¾" (9.5 cm), curved blunt blades, 15 mm long, ribbon type
- 18-1420** KNAPP Iris Scissors 4" (10.2 cm), straight, sharp-blunt points
- 18-1422** KNAPP Iris Scissors 4" (10.2 cm), straight, blunt-blunt points
- 18-1426** KNAPP Iris Scissors 4" (10.2 cm), curved, sharp-blunt points
- 18-1428** KNAPP Iris Scissors 4" (10.2 cm), curved, blunt-blunt points
- 18-1440** WILMER Utility Scissors 4" (10.2 cm), angled on flat
- 5-312** Strabismus Scissors 4" (10.2 cm), straight
- 5-314** Strabismus Scissors 4" (10.2 cm), curved
- 18-1453*** Strabismus Scissors 4¼"(10.8 cm), straight, ribbon type
- 18-1454*** Strabismus Scissors 4¼"(10.8 cm), curved, ribbon type



*Ribbon Type Scissors have extra large finger rings; shanks and rings have satin finish; blades are highly polished



18-1460 to 18-1476

18-1460 to 18-1466

18-1470 to 18-1476

18-1477*
18-1478*

21-539

18-1510 to 18-1514

STEVENS TENOTOMY SCISSORS

- 18-1460 Straight sharp points 4 1/8" (10.5 cm), short blades
- 18-1462 Straight blunt points 4 1/8" (10.5 cm), short blades
- 18-1464 Curved sharp points 4 1/8" (10.5 cm), short blades
- 18-1466 Curved blunt points 4 1/8" (10.5 cm), short blades
- 18-1470 Straight sharp points 4 1/2" (11.4 cm), long blades
- 18-1472 Straight blunt points 4 1/2" (11.4 cm), long blades
- 18-1474 Curved sharp points 4 1/2" (11.4 cm), long blades
- 18-1476 Curved blunt points 4 1/2" (11.4 cm), long blades
- 18-1477* STEVENS Tenotomy Scissors 3 3/4" (9.5 cm), straight, blunt points, ribbon type
- 18-1478* STEVENS Tenotomy Scissors 3 3/4" (9.5 cm), curved, blunt points, ribbon type

- 21-539 KLEINERT-KUTZ Tenotomy Scissors 4 7/8" (12.4 cm), curved, rounded dissecting blades

- 18-1510 NOYES Iris Scissors 4 1/2" (11.4 cm), straight, sharp-sharp points
- 18-1512 NOYES Iris Scissors 4 1/2" (11.4 cm), straight, sharp-blunt points
- 18-1514 NOYES Iris Scissors 4 1/2" (11.4 cm), straight, blunt-blunt points
- 18-1516 NOYES Iris Scissors 4 1/2" (11.4 cm), curved, sharp-sharp points

- 18-1480 WESTCOTT Eye Scissors 4 1/2" (11.4 cm), curved, blunt points
- 18-1486 WESTCOTT Eye Scissors 4 1/2" (11.4 cm), curved, sharp points



18-1516

18-1480

18-1486

*Ribbon Type Scissors have extra large finger rings; shanks and rings have satin finish; blades are highly polished



33-240



33-242

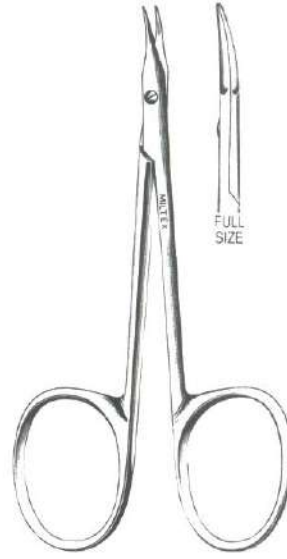

18-1652

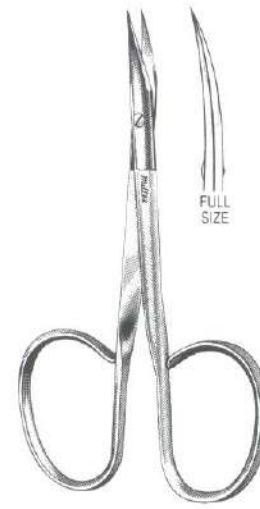

18-1653*



21-537TC

33-240 BIRO Dermal Naevus Scissors 4" (10.2 cm), angled on flat, w/sharp outside edges

33-242 MILTEX Undermining Scissors 4½" (11.4 cm), curved blades, with flat pointed tip

18-1652 GRADLE Scissors 3¾" (9.5 cm), slightly curved, sharp points

18-1653* GRADLE Scissors 4" (10.2 cm), ribbon type, slightly curved, sharp points

21-537TC MILTEX Blepharoplasty Scissors 4½" (11.4 cm), curved flat tips, one serrated and one Carb-N-Sert blade

21-630 JOSEPH Scissors 5¾" (14.6 cm), straight, sharp points

21-632 JOSEPH Scissors 5¾" (14.6 cm), curved, sharp points



21-630

21-632

*Ribbon Type Scissors have extra large finger rings; shanks and rings have satin finish; blades are highly polished



5-180



5-284

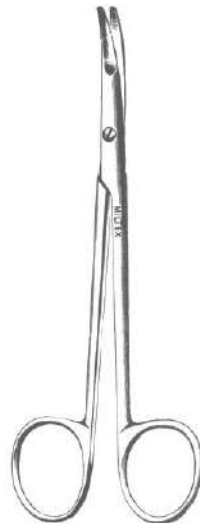

5-290

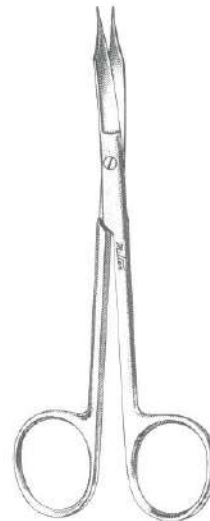

5-320

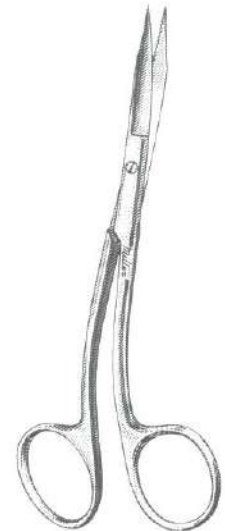

5D-322

- 5-180 METZENBAUM Scissors 5½" (14 cm), curved, standard
- 5-284 METZENBAUM Scissors 5" (12.7 cm), curved, delicate
- 5-290 RAGNELL Undermining Scissors 5" (12.7 cm), curved with flattened dissecting tips
- 5-320 GOLDMAN-FOX Wound Debridement Scissors 5" (12.7 cm), curved fine tips with one serrated blade
- 5D-322 GOLDMAN-FOX Wound Debridement Scissors 5" (12.7 cm), curved, one serrated blade, angled shanks
- 5D-324 LA GRANGE Scissors 4¼" (10.8 cm), curved, one serrated blade, angled shanks

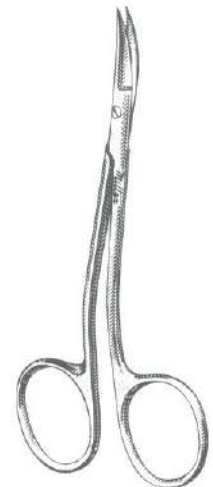

5D-324

For Carb-N-Sert Scissors with tungsten carbide inserts and SuperCut Scissors see pages 55 - 63



9-100

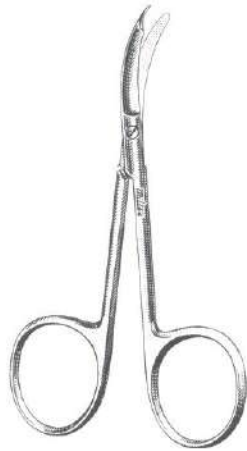

9-101

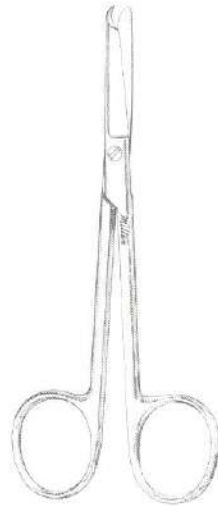

9-102

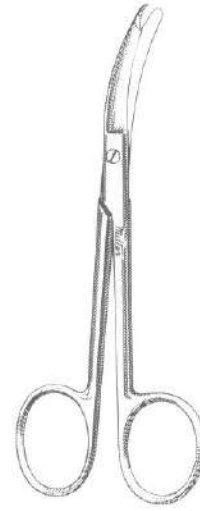

9-103

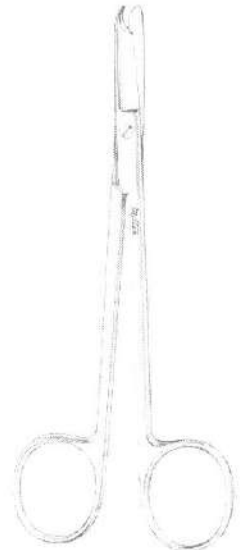

9-104

- 9-100 SPENCER Stitch Scissors 3½" (8.9 cm), delicate
- 9-101 SHORTBENT Stitch Scissors 3½" (8.9 cm), curved, delicate
- 9-102 LITTAUER JR. Stitch Scissors 4½" (11.4 cm), light pattern
- 9-103 NORTHBENT Stitch Scissors 4¾" (12.1 cm), curved, light pattern
- 9-104 LITTAUER Stitch Scissors 5½" (14 cm), standard pattern
- 9-108 MILTEX Stitch Scissors 4½" (11.4 cm), angled, delicate
- 9-110 O'BRIEN Stitch Scissors 3¾" (9.5 cm), angled, sharp points

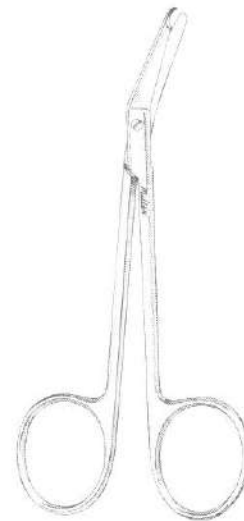

9-108

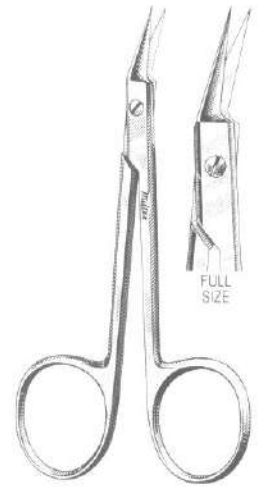

9-110



8-4



8-6

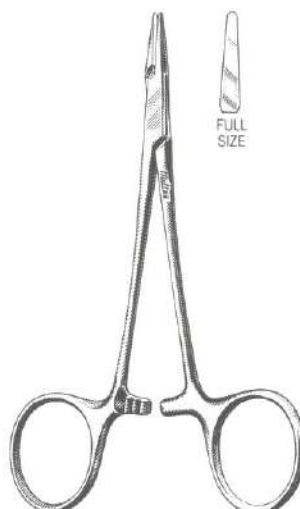

8-7

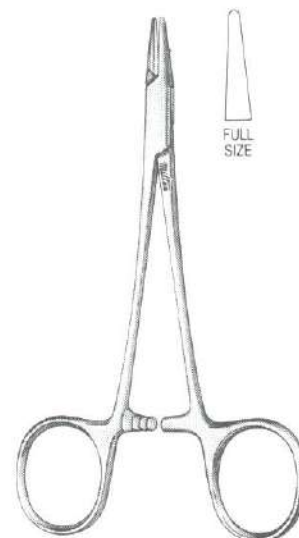

8-8

8-4 DERF Needle Holder 4 $\frac{3}{4}$ " (12.1 cm)

8-6 WEBSTER Needle Holder 5" (12.7 cm), delicate smooth jaws, standard pattern

8-7 WEBSTER Needle Holder 4 $\frac{3}{4}$ " (12.1 cm), extra delicate smooth jaws

8-8 HALSEY Needle Holder 5" (12.7 cm), smooth jaws

8D-36 HALSEY Needle Holder 5" (12.7 cm), serrated jaws

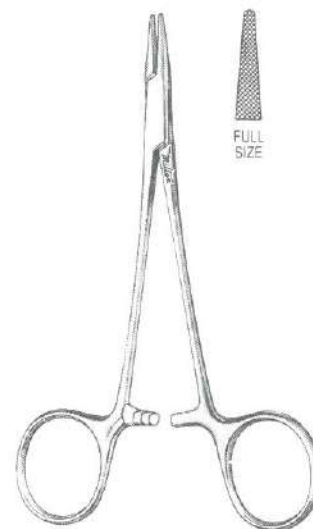

8D-36

For additional Needle Holders see pages 112 - 121

For Carb-N-Sert Needle Holders with tungsten carbide inserts see pages 123 - 130



8-14
8-14A

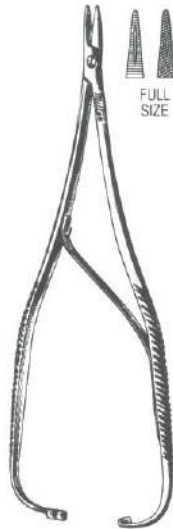

8-26



8-28



8-40

- 8-14** OLSEN-HEGAR Needle Holder-Scissor Combination 4¾" (12.1 cm), serrated jaws, extra delicate
- 8-14A** OLSEN-HEGAR Needle Holder-Scissor Combination 4¾" (12.1 cm), smooth jaws, extra delicate
- 8-26** BOYNTON Needle Holder 5" (12.7 cm), delicate
- 8-28** MATHIEU Needle Holder 5½" (14 cm), with spring handles
- 8-40** BAUMGARTNER Needle Holder 5½" (14 cm)
- 18-1800** KALT Needle Holder 5¼" (13.3 cm), standard model, delicate jaws
- 18-1810** GREEN Needle Holder and Suturing Forceps 4¼" (10.8 cm), angled jaws, double end



18-1800



18-1810

For additional Needle Holders see pages 112 - 121

For Carb-N-Sert Needle Holders with tungsten carbide inserts see pages 123 - 130

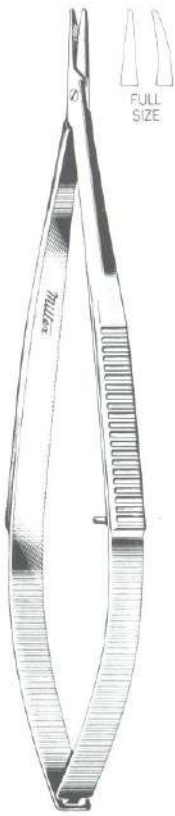

18-1820
18-1824



18-1828
18-1832

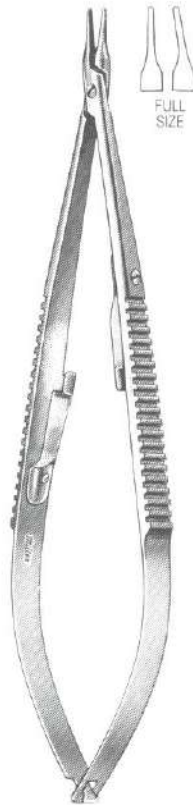

18-1831
18-1833

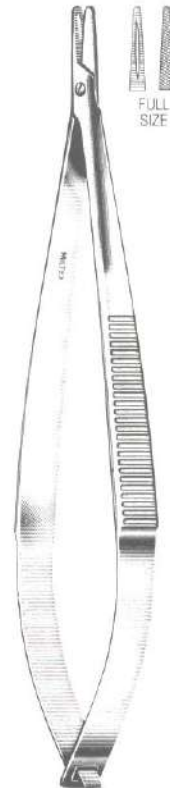

18-1834

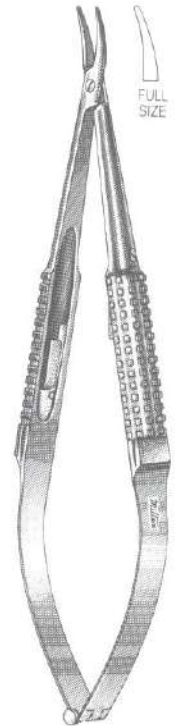

18-1838
18-1839

- 18-1820 CASTROVIEJO Needle Holder 5½" (14 cm), straight, without lock
- 18-1824 CASTROVIEJO Needle Holder 5½" (14 cm), curved, without lock
- 18-1828 CASTROVIEJO Needle Holder 5½" (14 cm), straight, with lock
- 18-1832 CASTROVIEJO Needle Holder 5½" (14 cm), curved, with lock
- 18-1831 CASTROVIEJO Needle Holder 5½" (14 cm), straight, extra delicate jaws, with lock
- 18-1833 CASTROVIEJO Needle Holder 5½" (14 cm), curved, extra delicate jaws, with lock
- 18-1834 PATON Needle Holder 4½" (11.4 cm), straight, without lock
- 18-1838 BARRAQUER Needle Holder 5" (12.7 cm), curved, without lock, 10 mm wide hollow round handles
- 18-1839 BARRAQUER Needle Holder 5" (12.7 cm), curved, with lock, 10 mm wide hollow round handles
- 18-1840 BARRAQUER Needle Holder 5⅞" (13 cm), curved, delicate tapered jaws, 8 mm wide hollow round handles

For additional Needle Holders see pages 112 - 121

For Carb-N-Sert Needle Holders with tungsten carbide inserts see pages 123 - 130

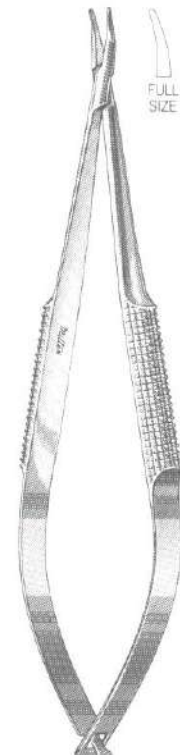

18-1840



6-104



6-106
6-108



6-107



6-118



6-118A

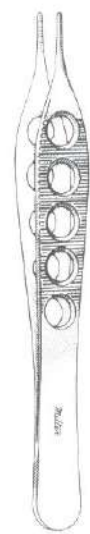

6-118XL



17-2510

- 6-104 SEMKEN Dressing Forceps 5" (12.7 cm), serrated
- 6-106 SEMKEN Tissue Forceps 5" (12.7 cm), 1 x 2 teeth
- 6-107 SEMKEN Tissue Forceps 5" (12.7 cm), 1 x 2 teeth, curved tips
- 6-108 SEMKEN Tissue Forceps 5" (12.7 cm), 2 x 3 teeth
- 6-118 ADSON Dressing Forceps 4³/₄" (12.1 cm), serrated, delicate
- 6-118A ADSON Dressing Forceps 4³/₄" (12.1 cm), serrated, delicate, angled
- 6-118XL ADSON Dressing Forceps 4³/₄" (12.1 cm), serrated, lightweight, fenestrated handles
- 17-2510 Micro ADSON Dressing Forceps 4³/₄" (12.1 cm), serrated tips, 0.5 mm wide
- 6-120 ADSON Tissue Forceps 4³/₄" (12.1 cm), 1 x 2 teeth, delicate
- 6-120A ADSON Tissue Forceps 4³/₄" (12.1 cm), 1 x 2 teeth, delicate, angled
- 6-120XL ADSON Tissue Forceps 4³/₄" (12.1 cm), 1 x 2 teeth, lightweight, fenestrated handles

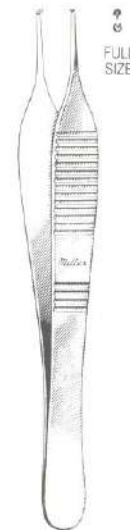

6-120

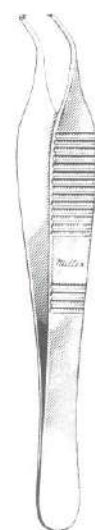

6-120A

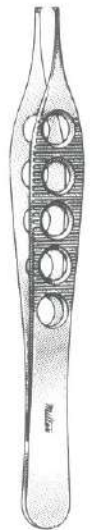

6-120XL

For additional Dressing and Tissue Forceps see pages 64 - 82

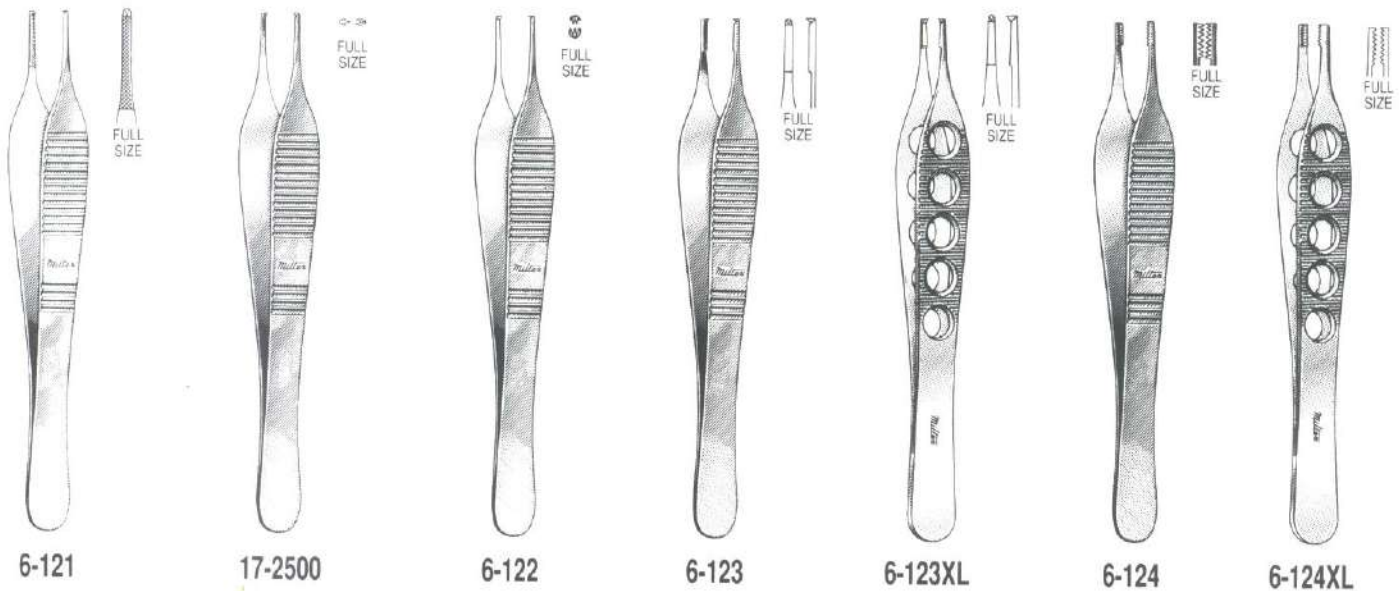

6-121 ADSON Tissue Forceps 4¾" (12.1 cm), 1 x 2 teeth, and cross serrated tips, delicate

17-2500 Micro ADSON Tissue Forceps 4¾" (12.1 cm), tips 0.5 mm wide, 1 x 2 teeth

6-122 ADSON Tissue Forceps 4¾" (12.1 cm), 2 x 3 teeth, delicate

6-123 ADSON Tissue and Suture Forceps 4¾" (12.1 cm), 1 x 2 teeth with tying platform

6-123XL ADSON Tissue Forceps 4¾" (12.1 cm), w/platform, 1 x 2 teeth, lightweight, fenestrated handles

6-124 BROWN-ADSON Tissue Forceps 4¾" (12.1 cm), 7 x 7 side grasping teeth

6-124XL BROWN-ADSON Tissue Forceps 4¾" (12.1 cm), 7 x 7 side grasping teeth, lightweight, fenestrated handles

6-125 DeBAKEY-ADSON Tissue Forceps 4¾" (12.1 cm), atraumatic tips 1.5 mm wide

24-570XL DeBAKEY Tissue Forceps 6' (15.2 cm), atraumatic tips, 1.5 mm wide, lightweight, fenestrated handles

6-126 BROWN-ADSON Tissue Forceps 4¾" (12.1 cm), 7 x 7 side grasping teeth, angular

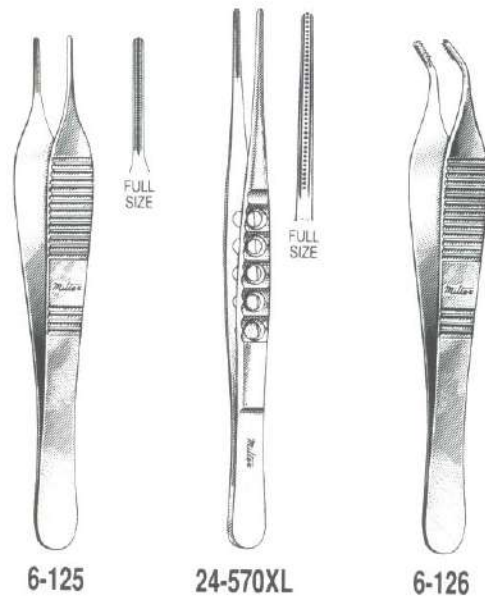

For additional Dressing and Tissue Forceps see pages 64 - 82



18-780



18-782



18-784



18-779

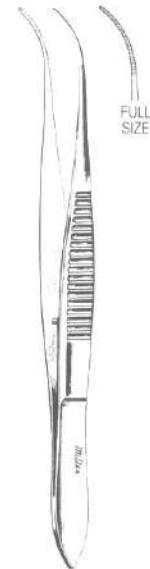

18-781



18-783

EYE DRESSING FORCEPS 4" (10.2 cm), SERRATED TIPS

Standard Pattern
0.8 mm wide tips

- 18-780 Straight
- 18-782 Half curved
- 18-784 Full curved

Extra Delicate Pattern
0.5 mm wide tips

- 18-779 Straight
- 18-781 Half curved
- 18-783 Full curved

For additional Dressing and Tissue Forceps see pages 64 - 82



IRIS TISSUE FORCEPS 4" (10.2 cm), 1 x 2 TEETH

Standard Pattern
0.8 mm wide tips

- 18-786 Straight
- 18-787 Straight (Non Magnetic)
- 18-788 Half curved
- 18-790 Full curved

Extra Delicate Pattern
0.5 mm wide tips

- 18-785 Straight
- 18-789 Half curved
- 18-791 Full curved

18-850 GRAEFE Tissue Forceps 4 $\frac{3}{8}$ " (11.2 cm), standard jaws 4.5 mm wide, with fine teeth

18-854 GRAEFE Tissue Forceps 4 $\frac{3}{8}$ " (11.2 cm), standard jaws 4.5 mm wide, with fine teeth, with catch



For additional Dressing & Tissue Forceps see pages 64 - 82

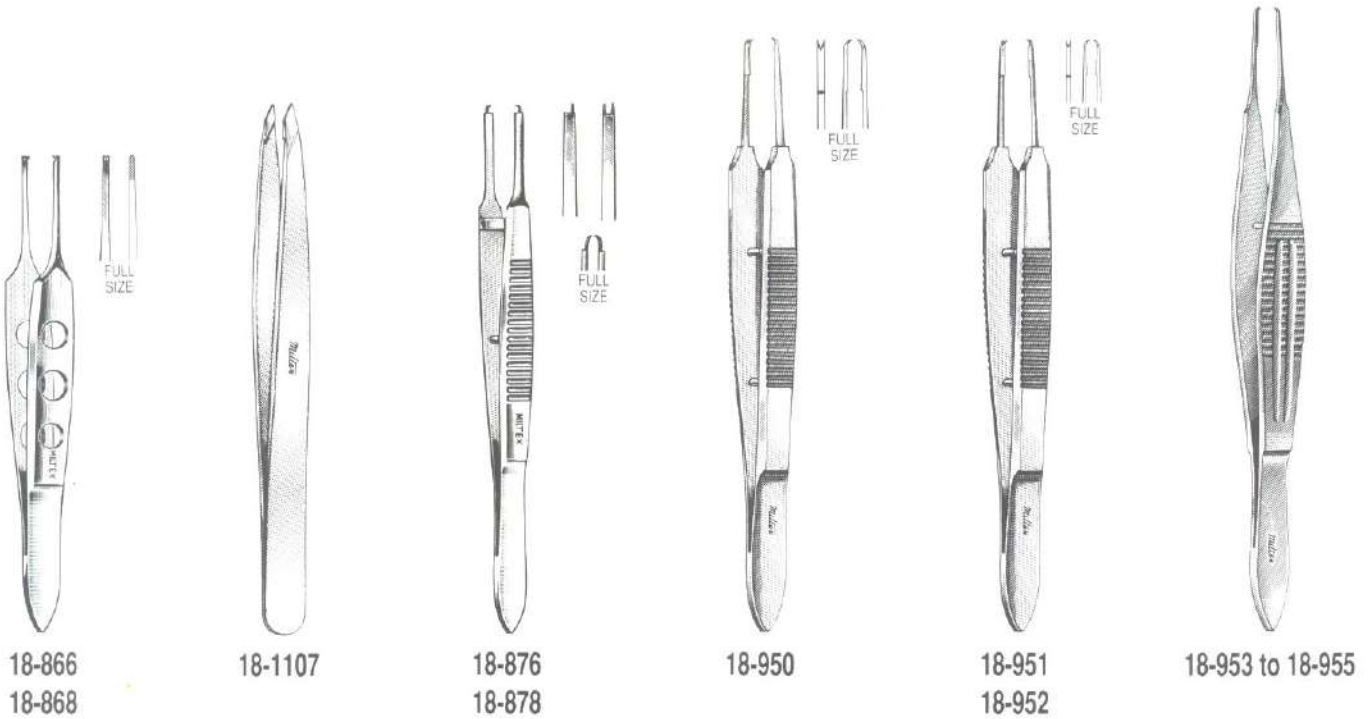

- 18-866** BISHOP-HARMON Dressing Forceps 3³/₈" (8.6 cm), fine cross serrated tips 0.5 mm wide
- 18-868** BISHOP-HARMON Tissue Forceps 3³/₈" (8.6 cm), standard 0.7 mm 1 x 2 teeth
- 18-1107** Swiss Cilia and Suture Forceps 3³/₄" (9.5 cm), precision fitted diagonal jaws 3 mm wide
- 18-876** CASTROVIEJO (ALVIN) Fixation Forceps 3³/₄" (9.5 cm), straight, 1 x 1 curved teeth extending beyond each other
- 18-878** CASTROVIEJO Fixation Forceps 3³/₄" (9.5 cm), straight, 2 x 2 curved teeth extending beyond each other
- 18-950** CASTROVIEJO Suturing Forceps 4" (10.2 cm), 1 x 2 teeth 0.9 mm, with tying platform
- 18-951** CASTROVIEJO Suturing Forceps 4" (10.2 cm), 1 x 2 teeth 0.3 mm, with tying platform
- 18-952** CASTROVIEJO Suturing Forceps 4" (10.2 cm), 1 x 2 teeth 0.6 mm, with tying platform
- 18-953** CASTROVIEJO Micro Suturing Forceps 4" (10.2 cm), with 11 mm wide handles, 1 x 2 teeth 0.12 mm, with tying platform
- 18-954** CASTROVIEJO Suturing Forceps 4" (10.2 cm), with 11 mm wide handles, 1 x 2 teeth 0.6 mm, with tying platform
- 18-955** CASTROVIEJO Suturing Forceps 4" (10.2 cm), with 11 mm wide handles, 1 x 2 teeth 0.9 mm, with tying platform

For additional Fixation and Suturing Forceps see pages 238, 244 - 248 & 251



33-280



21-430



26-1084
26-1086



33-121



18-412
18-414



18-416

- 33-280 LERNER Skin Hook Forceps 4½" (11.4 cm), for wound repair
- 21-430 MILTEX Tissue Twist Hook 5½" (14 cm)
- 26-1084 FRAZIER Skin Hook 5" (12.7 cm), sharp point
- 26-1086 FRAZIER Skin Hook 5" (12.7 cm), blunt point
- 33-121 SELTZER Dermal Biopsy Hook 4½" (11.4 cm), sharp point
- 18-412 TYRELL Skin Hook 5" (12.7 cm), sharp point
- 18-414 TYRELL Skin Hook 5" (12.7 cm), blunt point
- 18-416 GUTHRIE Hook 5" (12.7 cm), sharp double prongs 1.5 mm wide
- 21-85 KLEINERT-KUTZ Hook 5" (12.7 cm), small size 3 mm dia.
- 21-86 KLEINERT-KUTZ Hook 5" (12.7 cm), medium size 5 mm dia.
- 21-87 KLEINERT-KUTZ Hook 5" (12.7 cm), large size 7 mm dia.
- 21-88 GILLIES (CONVERSE) Skin Hook 7" (17.8 cm), large size
- 21-89 GILLIES (CONVERSE) Skin Hook 7" (17.8 cm), small size

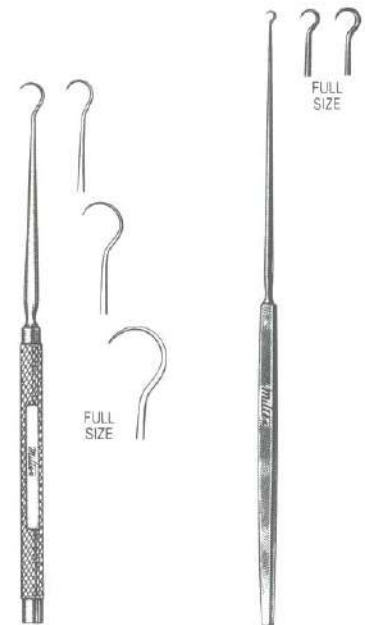

21-85 to 21-87

21-88
21-89

For additional Hooks see pages 188 - 194



21-90 to 21-94



21-102
21-103



21-144



21-152



21-153

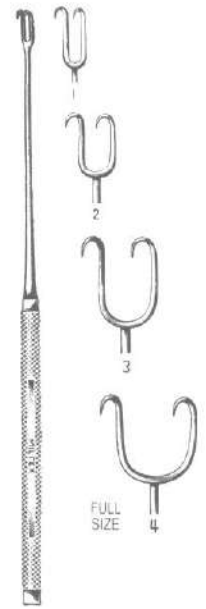

21-154 to 21-160

- 21-90 COTTLE Skin Hook 5½" (14 cm), small, shallow curve
- 21-92 COTTLE Skin Hook 5½" (14 cm), small, deep curve
- 21-94 COTTLE Skin Hook 5½" (14 cm), large, deep curve
- 21-102 FREER Skin Hook 6" (15.2 cm), sharp double prongs 2.5 mm wide
- 21-103 FREER Skin Hook 6" (15.2 cm), blunt double prongs 2.5 mm wide
- 21-144 COTTLE Double Hook 5½" (14 cm), two sharp prongs 12 mm wide
- 21-152 MILTEX Skin Hook 4¾" (12.1 cm), sharp prong 2 mm dia.
- 21-153 JOSEPH Single Hook 6¼" (15.9 cm), one sharp prong
- 21-154 JOSEPH Double Hook 6¼" (15.9 cm), two sharp prongs 2 mm
- 21-156 JOSEPH Double Hook 6¼" (15.9 cm), two sharp prongs 5 mm
- 21-158 JOSEPH Double Hook 6¼" (15.9 cm), two sharp prongs 7 mm
- 21-160 JOSEPH Double Hook 6¼" (15.9 cm), two sharp prongs 10 mm



- 18-100 ROLLET Retractor 5¼" (13.3 cm), with 4 sharp prongs
- 18-102 KNAPP Retractor 5¼" (13.3 cm), with 4 blunt prongs
- 18-439 MCGANNON Retractor 5" (12.7 cm), fenestrated blade 2.5 mm wide
- 11D-27 Flexible Neck Rake Retractor 5" (12.7 cm), 3 sharp prongs

RAKE RETRACTORS 6" (15.2 cm)

Sharp	With Flexible Neck	Blunt
11-30	1 prong	11-36
11-32	2 prongs	11-38
11-34	3 prongs	11-40

RAKE RETRACTORS 6" (15.2 cm)

Sharp	With Rigid Neck	Blunt
11-50	1 prong	11-56
11-52	2 prongs	11-58
11-54	3 prongs	11-60



11-12
11-13

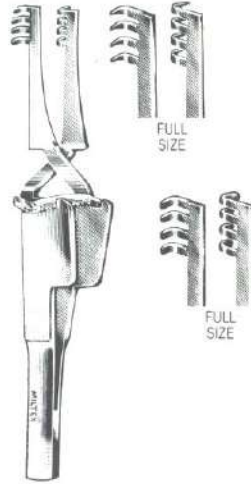

11-14
11-16



11-74
11-76



11-80
11-81

- 11-12 ALM Retractor 2¾" (7 cm), spread 2¼" (5.7 cm), prongs ⅛" (.32 cm) deep
- 11-13 ALM Retractor 3⅞" (9.8 cm), spread 3" (7.6 cm), prongs ½" (1.3 cm) deep
- 11-14 MILTEX Cross Action Retractor 4" (10.2 cm), sharp prongs
- 11-16 MILTEX Cross Action Retractor 4" (10.2 cm), blunt prongs
- 11-74 SENN Retractor 6⅜" (16.2 cm), sharp, double end
- 11-76 SENN Retractor 6⅜" (16.2 cm), blunt, double end
- 11-80 MATHIEU Retractor 6½" (16.5 cm), sharp, double end
- 11-81 MATHIEU Retractor 6½" (16.5 cm), blunt, double end

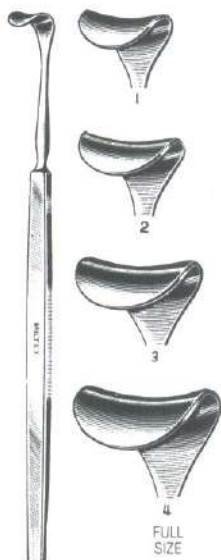

18-110 to 18-116



18-570

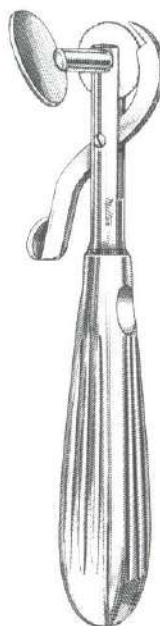

33-140
33-142



40-94
40-96

- 18-110 DESMARRES Eye Lid Retractor 5½" (14 cm), size 1, 11 mm
- 18-112 DESMARRES Eye Lid Retractor 5½" (14 cm), size 2, 13 mm
- 18-114 DESMARRES Eye Lid Retractor 5½" (14 cm), size 3, 15 mm
- 18-116 DESMARRES Eye Lid Retractor 5½" (14 cm), size 4, 17 mm

- 18-570 GREEN Spatula 6" (15.2 cm), slightly curved ends 4 x 14 mm and 5 x 16 mm

- 33-140 Finger Ring Cutter 6½" (16.5 cm), with circular saw blade, chrome
- 33-142 Replacement Blade for Finger Ring Cutter, chrome

- 40-94 LOCKE Elevator 4½" (11.4 cm), small blade 3 x 15 mm
- 40-96 LOCKE Elevator 5" (12.1 cm), large blade 5 x 20 mm

- 18-660 Flexible Stainless Ruler 6" (15.2 cm) x ½" (1.3 cm), graduated in 1/32" (.8 mm) fractions & mm

For Measuring Calipers see page 239



18-660



33-200



33-201
33-202



33-203



33-204
33-206



33-210

- 33-200 SCHAMBERG Comedone Extractor 3¾" (9.5 cm), with square loop ends
- 33-201 SCHAMBERG Comedone Extractor 3¾" (9.5 cm), standard pattern with crimped small loop
- 33-202 SCHAMBERG Comedone Extractor 3¾" (9.5 cm), standard pattern with extra fine loops, small loop crimped

- 33-203 Comedone Extractor 4" (10.2 cm), double end, flat and wire end expressors

- 33-204 SAALFIELD Comedone Extractor 5¾" (14.6 cm), with acne lancet, professional pattern
- 33-206 SAALFIELD Comedone Extractor 4¼" (10.8 cm), with acne lancet, professional pattern

- 33-210 UNNA Comedone Extractor 5¾" (14.6 cm), spoon ends



- 33-214** MILTEX Comedone Extractor 6" (15.2 cm), one fenestrated cup and one delicate curved lancet with protective cap
- 33-215** GREG Comedone Extractor 5" (12.7 cm), one fenestrated cup and chuck with interchangeable No. 65 lancet blade, protected by cap
- 33-216** Replacement Blade No. 65 for No. 33-215 Comedone Extractor
- 33-230** Finger Nail Drill 4" (10.2 cm), standard pattern, complete with 3 drill points stored in handle
- 33-232** Finger Nail Drill 4½" (11.4 cm), with Chuck Head, complete with 3 drill points stored in handle
- 33-234** Set of 3 Drill Points, small, medium and large size, for Finger Nail Drills, chrome
- 33-500** MILTEX Depilatory Forceps 5¼" (13.3 cm), flat square tips with deep serrations

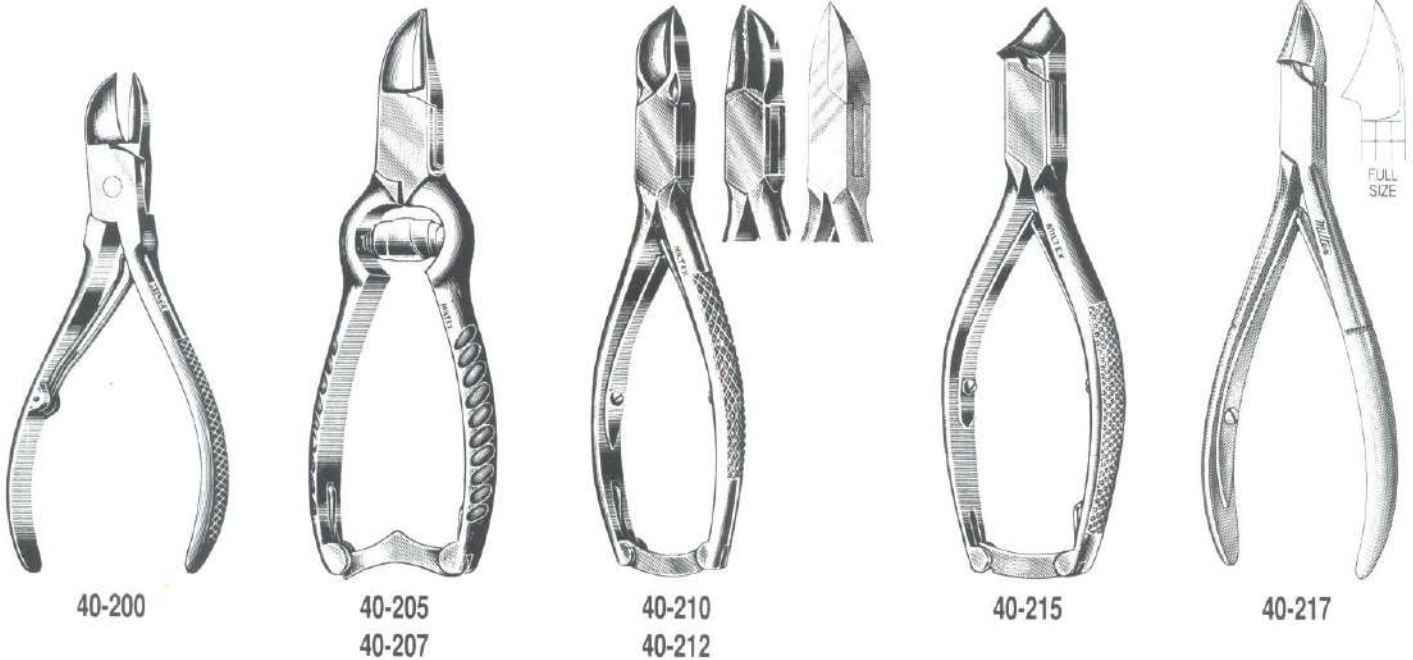

- 40-200** Nail Nipper 4½" (11.4 cm), concave jaws, single spring, chrome
- 40-205** Nail Nipper 4½" (11.4 cm), concave jaws, barrel spring, chrome
- 40-207** Nail Nipper 5½" (14 cm), concave jaws, barrel spring, chrome
- 40-210-CH** Nail Nipper 5½" (14 cm), concave jaws, double spring, chrome
- 40-210-SS** Nail Nipper 5½" (14 cm), concave jaws, double spring, stainless
- 40-212-CH** Nail Nipper 5½" (14 cm), straight jaws, double spring, chrome
- 40-212-SS** Nail Nipper 5½" (14 cm), straight jaws, double spring, stainless
- 40-215-CH** Nail Nipper 5½" (14 cm), angled concave jaws, double spring, chrome
- 40-215-SS** Nail Nipper 5½" (14 cm), angled concave jaws, double spring, stainless
- 40-217** Nail Nipper 5" (12.7 cm), concave jaws, double spring, stainless
- 40-219** Double Action Nail Nipper 6" (15.2 cm), sharp concave jaws, barrel spring, stainless

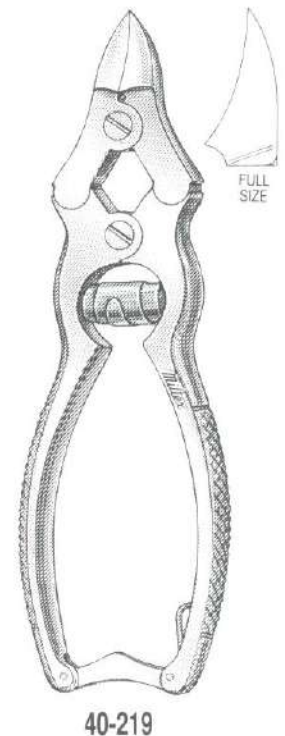

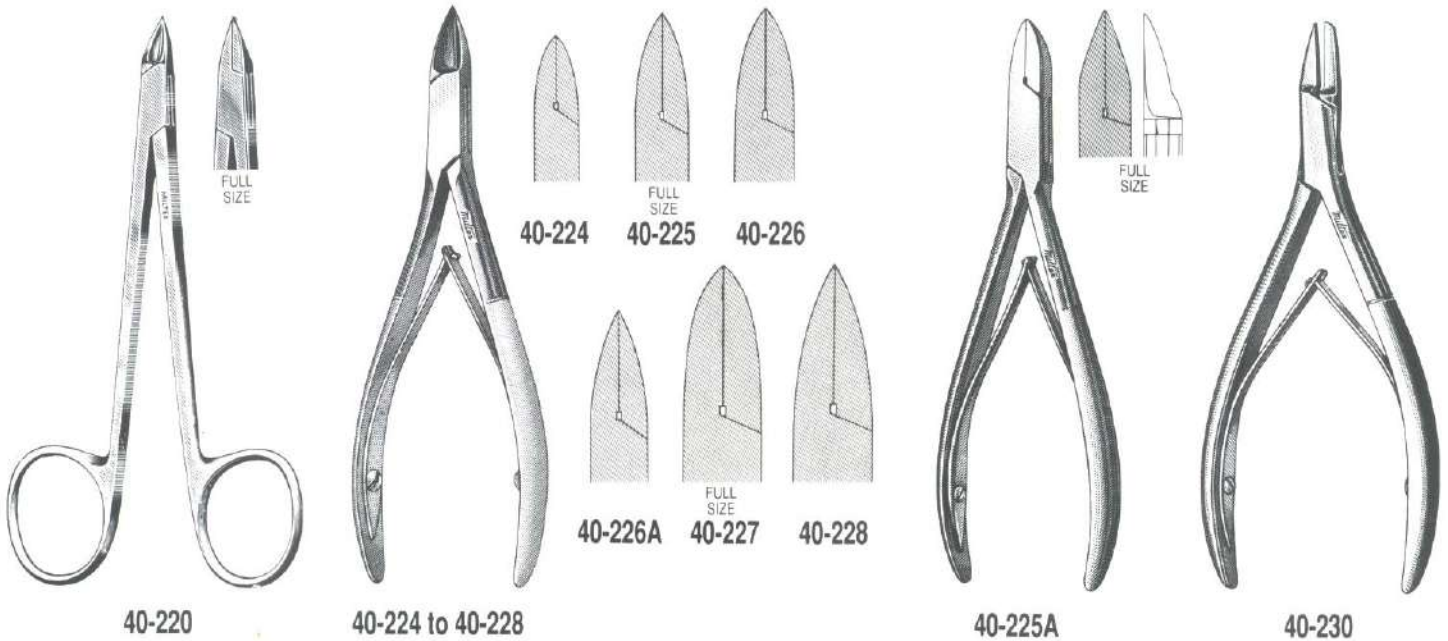

- 40-220** Tissue and Cuticle Nipper 4" (10.2 cm), straight jaws, ring handles, chrome
- 40-224** Nail Splitter 4" (10.2 cm), straight jaws, double spring, stainless
- 40-225A** Nail Splitter 4½" (11.4 cm), delicate straight jaws, double spring, stainless
- 40-225-CH** Nail Splitter 4½" (11.4 cm), straight jaws, single spring, chrome
- 40-225-SS** Nail Splitter 4½" (11.4 cm), straight jaws, double spring, stainless
- 40-226A** Nail Splitter 5" (12.7 cm), straight jaws, extra narrow, double spring, stainless
- 40-226-CH** Nail Splitter 5" (12.7 cm), straight jaws, single spring, chrome
- 40-226-SS** Nail Splitter 5" (12.7 cm), straight jaws, double spring, stainless
- 40-227-CH** Nail Splitter 6" (15.2 cm), straight jaws, single spring, chrome
- 40-227-SS** Nail Splitter 6" (15.2 cm), straight jaws, double spring, stainless
- 40-228** Nail Splitter 6" (15.2 cm), straight jaws, extra narrow, double spring, stainless
- 40-230** Nail Splitter 5" (12.7 cm), English Anvil Pattern, double spring, stainless
- 40-234** PLATYPUS Nail Pulling Forceps 5½" (14 cm), standard wide jaws, stainless
- 40-235** PLATYPUS Nail Pulling Forceps 5½" (14 cm), narrow jaws, stainless

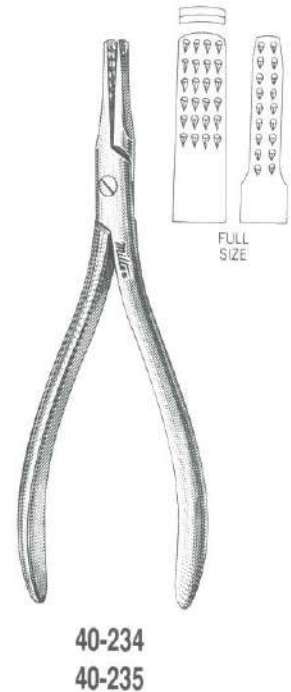



- 40-245-CH** Tissue and Cuticle Nipper 4" (10.2 cm), convex jaws, chrome
- 40-245-SS** Tissue and Cuticle Nipper 4" (10.2 cm), convex jaws, stainless
- 40-250-CH** Tissue and Cuticle Nipper 4½" (11.4 cm), convex jaws, chrome
- 40-250-SS** Tissue and Cuticle Nipper 4½" (11.4 cm), convex jaws, stainless
- 40-251-CH** Tissue and Cuticle Nipper 5" (12.7 cm), convex jaws, chrome
- 40-251-SS** Tissue and Cuticle Nipper 5" (12.7 cm), convex jaws, stainless
- 40-252** Tissue and Cuticle Nipper 5" (12.7 cm), convex jaws, heavy pattern, stainless
- 40-425** Nail Scissors 3½" (8.9 cm), curved blades, chrome
- 40-435** Cuticle Scissors 3½" (8.9 cm), curved blades, standard pattern, chrome
- 40-445** Cuticle Scissors 3½" (8.9 cm), curved blades, extra delicate, chrome
- 40-260** Ingrown Nail Splitting Scissors 6" (15.2 cm), stainless



40-260



34-50
34-52



34-80



34-92

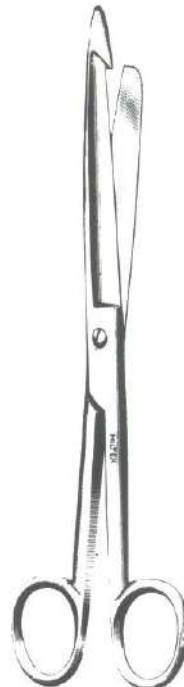

34-98

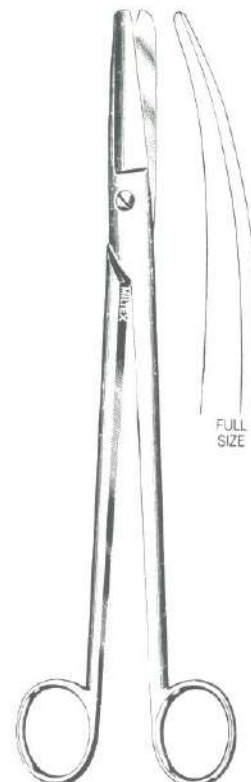

30-2605

- 34-50 VIRCHOW Brain Sectioning Knife, blade 180 mm x 20 mm, double edge
- 34-52 VIRCHOW Brain Sectioning Knife, blade 250 mm x 40 mm, double edge
- 34-80 Dissecting Scissors 4½" (11.4 cm), straight, two sharp points, economy grade
- 34-92 RICHTER Dissecting Scissors 5" (12.7 cm), angular blades, one sharp and one blunt point
- 34-98 Enterotomy Scissors 8" (20.3 cm), with hook blade
- 30-2605 DUBOIS Scissors 10½" (26.7 cm), curved, blunt points, extra heavy pattern
- 25-360 GLUCK Rib Shears 8½" (21.6 cm)

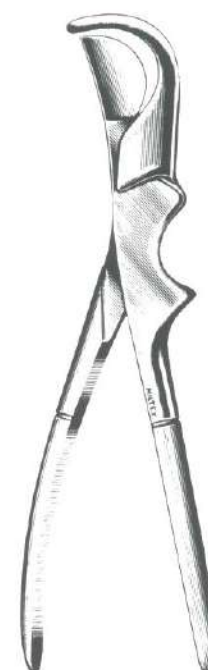

25-360

For a complete selection of Scissors see pages 18 - 52

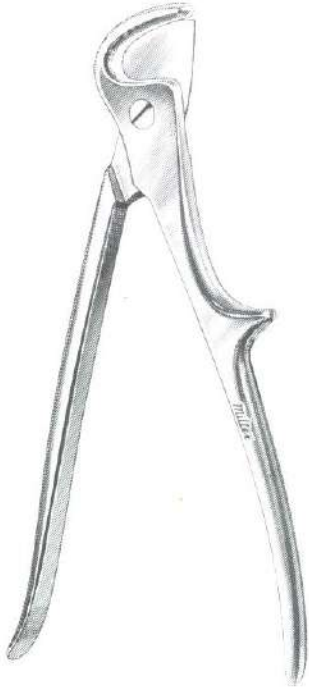

25-362

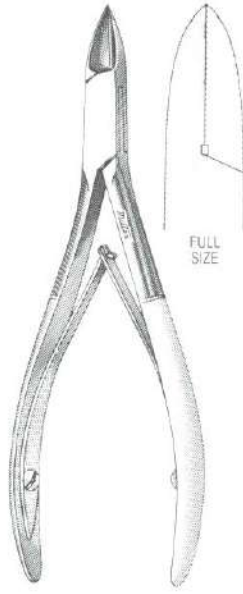

40-227-SS



34-210



34-220

- 25-362 STILLE Pattern Rib Shears 8½" (21.6 cm)
- 40-227-SS LITTAUER-LISTON Bone Cutting Forceps 6" (15.2 cm), straight 20 mm blades
- 34-210 VIRCHOW Skull Breaker 3" (7.6 cm), blade ½" (1.3 cm) wide
- 34-220 Post Mortem Hammer 9½" (24.1 cm), with hook handle
- 34-250 Dissecting Tenaculum 6½" (16.5 cm), sharp point
- 34-256 Aneurysm Needle 6½" (16.5 cm), blunt tip with eye



34-250



34-256

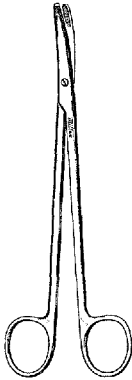

5-180

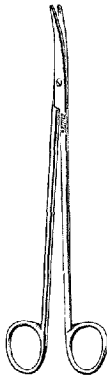

5-284



5-290

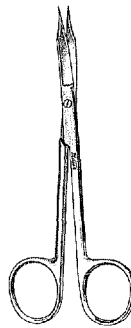

5-320

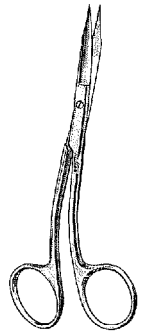

5D-322

- 5-180 METZENBAUM Scissors 5½" (14 cm), curved, standard
- 5-284 METZENBAUM Scissors 5" (12.7 cm), curved, delicate
- 5-290 RAGNELL Undermining Scissors 5" (12.7 cm), curved with flattened dissecting tips
- 5-320 GOLDMAN-FOX Wound Debridement Scissors 5" (12.7 cm), curved fine tips with one serrated blade
- 5D-322 GOLDMAN-FOX Wound Debridement Scissors 5" (12.7 cm), curved, one serrated blade, angled shanks
- 5D-324 LA GRANGE Scissors 4¼" (10.8 cm), curved, one serrated blade, angled shanks

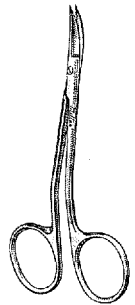

5D-324

For Carb-N-Sert Scissors with tungsten carbide inserts
and SuperCut Scissors see pages 55 - 63

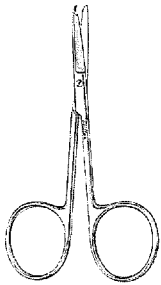

9-100

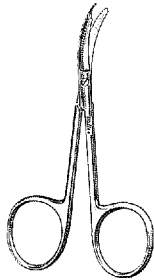

9-101

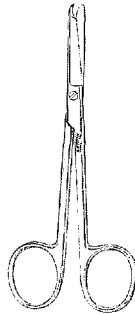

9-102

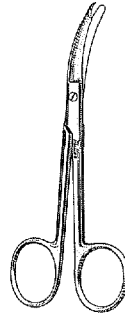

9-103

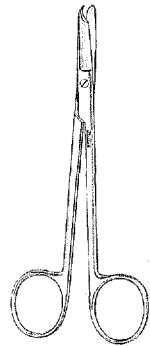

9-104

- 9-100 SPENCER Stitch Scissors 3½" (8.9 cm), delicate
- 9-101 SHORTBENT Stitch Scissors 3½" (8.9 cm), curved, delicate
- 9-102 LITTAUER JR. Stitch Scissors 4½" (11.4 cm), light pattern
- 9-103 NORTHBENT Stitch Scissors 4¾" (12.1 cm), curved, light pattern
- 9-104 LITTAUER Stitch Scissors 5½" (14 cm), standard pattern
- 9-108 MILTEX Stitch Scissors 4½" (11.4 cm), angled, delicate
- 9-110 O'BRIEN Stitch Scissors 3¾" (9.5 cm), angled, sharp points

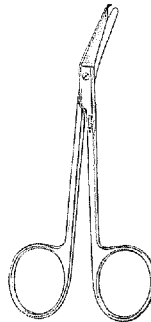

9-108

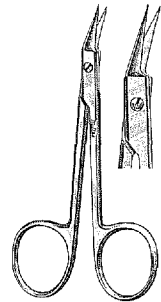

9-110

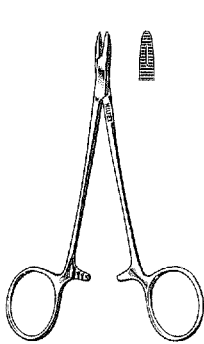

8-4

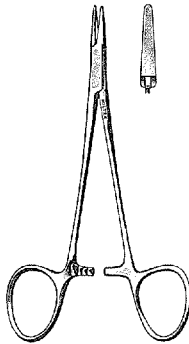

8-6

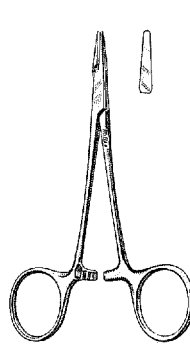

8-7

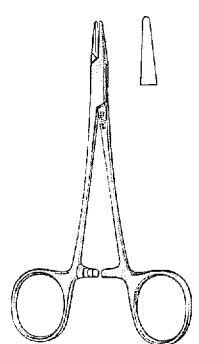

8-8

- 8-4 DERF Needle Holder 4¾" (12.1 cm)
- 8-6 WEBSTER Needle Holder 5" (12.7 cm), delicate smooth jaws, standard pattern
- 8-7 WEBSTER Needle Holder 4¾" (12.1 cm), extra delicate smooth jaws
- 8-8 HALSEY Needle Holder 5" (12.7 cm), smooth jaws
- 8D-36 HALSEY Needle Holder 5" (12.7 cm), serrated jaws

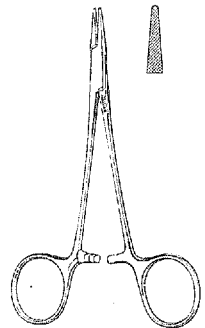

8D-36

For additional Needle Holders see pages 112 - 121

For Carb-N-Sert Needle Holders with tungsten carbide inserts see pages 123 - 130

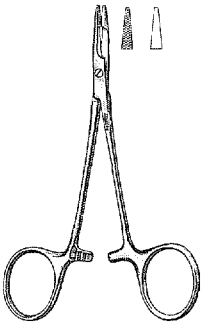

8-14
8-14A

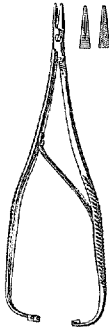

8-26

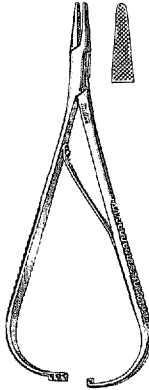

8-28

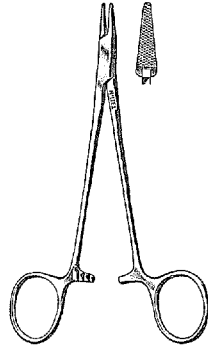

8-40

- 8-14 OLSEN-HEGAR Needle Holder-Scissor Combination 4¾" (12.1 cm), serrated jaws, extra delicate
- 8-14A OLSEN-HEGAR Needle Holder-Scissor Combination 4¾" (12.1 cm), smooth jaws, extra delicate
- 8-26 BOYNTON Needle Holder 5" (12.7 cm), delicate
- 8-28 MATHIEU Needle Holder 5½" (14 cm), with spring handles
- 8-40 BAUMGARTNER Needle Holder 5½" (14 cm)
- 18-1800 KALT Needle Holder 5¼" (13.3 cm), standard model, delicate jaws
- 18-1810 GREEN Needle Holder and Suturing Forceps 4¼" (10.8 cm), angled jaws, double end

For additional Needle Holders see pages 112 - 121

For Carb-N-Sert Needle Holders with tungsten carbide inserts see pages 123 - 130

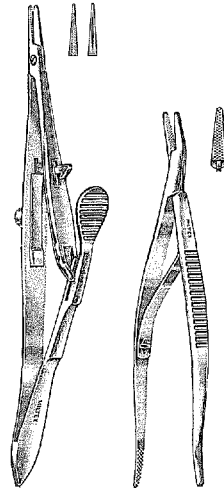

18-1800

18-1810

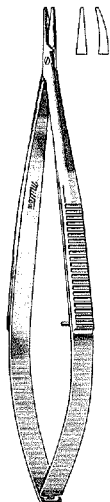

18-1820
18-1824



18-1828
18-1832

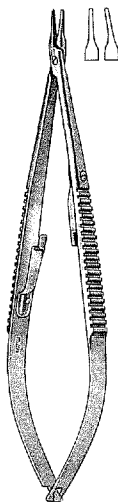

18-1831
18-1833

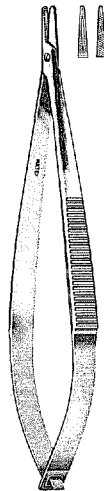

18-1834

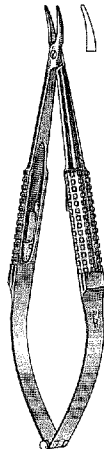

18-1838
18-1839

- 18-1820 CASTROVIEJO Needle Holder 5½" (14 cm), straight, without lock
- 18-1824 CASTROVIEJO Needle Holder 5½" (14 cm), curved, without lock
- 18-1828 CASTROVIEJO Needle Holder 5½" (14 cm), straight, with lock
- 18-1832 CASTROVIEJO Needle Holder 5½" (14 cm), curved, with lock
- 18-1831 CASTROVIEJO Needle Holder 5½" (14 cm), straight, extra delicate jaws, with lock
- 18-1833 CASTROVIEJO Needle Holder 5½" (14 cm), curved, extra delicate jaws, with lock
- 18-1834 PATON Needle Holder 4½" (11.4 cm), straight, without lock
- 18-1838 BARRAQUER Needle Holder 5" (12.7 cm), curved, without lock, 10 mm wide hollow round handles
- 18-1839 BARRAQUER Needle Holder 5" (12.7 cm), curved, with lock, 10 mm wide hollow round handles
- 18-1840 BARRAQUER Needle Holder 5½" (13 cm), curved, delicate tapered jaws, 8 mm wide hollow round handles

For additional Needle Holders see pages 112 - 121

For Carb-N-Sert Needle Holders with tungsten carbide inserts see pages 123 - 130

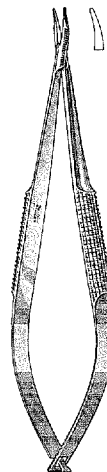

18-1840



6-104

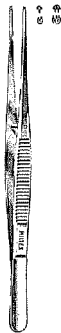

6-106
6-108



6-107



6-118



6-118A



6-118XL

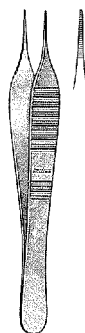

17-2510

- 6-104 SEMKEN Dressing Forceps 5" (12.7 cm), serrated
- 6-106 SEMKEN Tissue Forceps 5" (12.7 cm), 1 x 2 teeth
- 6-107 SEMKEN Tissue Forceps 5" (12.7 cm), 1 x 2 teeth, curved tips
- 6-108 SEMKEN Tissue Forceps 5" (12.7 cm), 2 x 3 teeth
- 6-118 ADSON Dressing Forceps 4 3/4" (12.1 cm), serrated, delicate
- 6-118A ADSON Dressing Forceps 4 3/4" (12.1 cm), serrated, delicate, angled
- 6-118XL ADSON Dressing Forceps 4 3/4" (12.1 cm), serrated, lightweight, fenestrated handles
- 17-2510 Micro ADSON Dressing Forceps 4 3/4" (12.1 cm), serrated tips, 0.5 mm wide
- 6-120 ADSON Tissue Forceps 4 3/4" (12.1 cm), 1 x 2 teeth, delicate
- 6-120A ADSON Tissue Forceps 4 3/4" (12.1 cm), 1 x 2 teeth, delicate, angled
- 6-120XL ADSON Tissue Forceps 4 3/4" (12.1 cm), 1 x 2 teeth, lightweight, fenestrated handles



6-120



6-120A

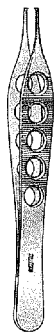

6-120XL

For additional Dressing and Tissue Forceps see pages 64 - 82

Dermal Instruments



6-121

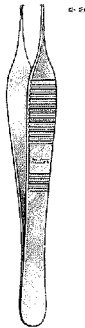

17-2500



6-122

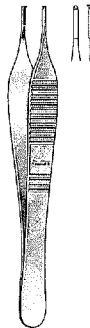

6-123

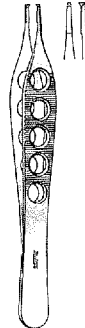

6-123XL



6-124

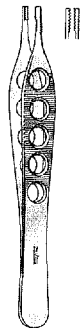

6-124XL

6-121 ADSON Tissue Forceps 4 $\frac{3}{4}$ " (12.1 cm), 1 x 2 teeth, and cross serrated tips, delicate

17-2500 Micro ADSON Tissue Forceps 4 $\frac{3}{4}$ " (12.1 cm), tips 0.5 mm wide, 1 x 2 teeth

6-122 ADSON Tissue Forceps 4 $\frac{3}{4}$ " (12.1 cm), 2 x 3 teeth, delicate

6-123 ADSON Tissue and Suture Forceps 4 $\frac{3}{4}$ " (12.1 cm), 1 x 2 teeth with tying platform

6-123XL ADSON Tissue Forceps 4 $\frac{3}{4}$ " (12.1 cm), w/platform, 1 x 2 teeth, lightweight, fenestrated handles

6-124 BROWN-ADSON Tissue Forceps 4 $\frac{3}{4}$ " (12.1 cm), 7 x 7 side grasping teeth

6-124XL BROWN-ADSON Tissue Forceps 4 $\frac{3}{4}$ " (12.1 cm), 7 x 7 side grasping teeth, lightweight, fenestrated handles

6-125 DeBAKEY-ADSON Tissue Forceps 4 $\frac{3}{4}$ " (12.1 cm), atraumatic tips 1.5 mm wide

24-570XL DeBAKEY Tissue Forceps 6" (15.2 cm), atraumatic tips, 1.5 mm wide, lightweight, fenestrated handles

6-126 BROWN-ADSON Tissue Forceps 4 $\frac{3}{4}$ " (12.1 cm), 7 x 7 side grasping teeth, angular

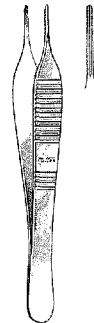

6-125



24-570XL



6-126

For additional Dressing and Tissue Forceps see pages 64 - 82



18-780

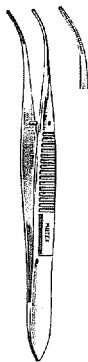

18-782

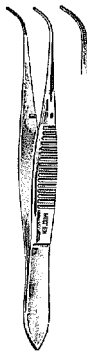

18-784



18-779

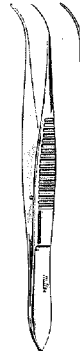

18-781



18-783

EYE DRESSING FORCEPS 4" (10.2 cm), SERRATED TIPS

Standard Pattern
0.8 mm wide tips

18-780 Straight
18-782 Half curved
18-784 Full curved

Extra Delicate Pattern
0.5 mm wide tips

18-779 Straight
18-781 Half curved
18-783 Full curved

For additional Dressing and Tissue Forceps see pages 64 - 82



18-786
18-787

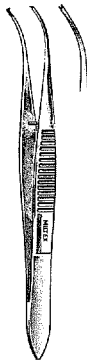

18-788

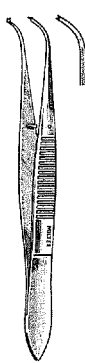

18-790



18-785

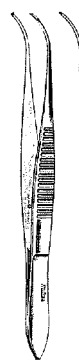

18-789

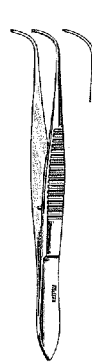

18-791

IRIS TISSUE FORCEPS 4" (10.2 cm), 1 x 2 TEETH

Standard Pattern 0.8 mm wide tips		Extra Delicate Pattern 0.5 mm wide tips	
18-786	Straight	18-785	Straight
18-787	Straight (Non Magnetic)	18-789	Half curved
18-788	Half curved	18-791	Full curved
18-790	Full curved		
18-850	GRAEFE Tissue Forceps 4" (11.2 cm), standard jaws 4.5 mm wide, with fine teeth		
18-854	GRAEFE Tissue Forceps 4" (11.2 cm), standard jaws 4.5 mm wide, with fine teeth, with catch		

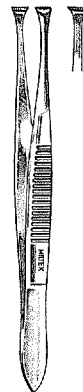

18-850



18-854

For additional Dressing & Tissue Forceps see pages 64 - 82



18-866
18-868



18-1107



18-876
18-878

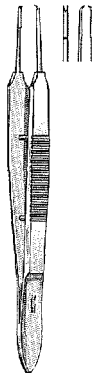

18-950

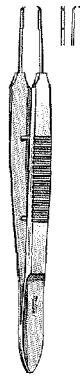

18-951
18-952



18-953 to 18-955

- 18-866** BISHOP-HARMON Dressing Forceps 3 $\frac{3}{4}$ " (8.6 cm), fine cross serrated tips 0.5 mm wide
- 18-868** BISHOP-HARMON Tissue Forceps 3 $\frac{3}{4}$ " (8.6 cm), standard 0.7 mm 1 x 2 teeth
- 18-1107** Swiss Cilia and Suture Forceps 3 $\frac{3}{4}$ " (9.5 cm), precision fitted diagonal jaws 3 mm wide
- 18-876** CASTROVIEJO (ALVIN) Fixation Forceps 3 $\frac{3}{4}$ " (9.5 cm), straight,
1 x 1 curved teeth extending beyond each other
- 18-878** CASTROVIEJO Fixation Forceps 3 $\frac{3}{4}$ " (9.5 cm), straight,
2 x 2 curved teeth extending beyond each other
- 18-950** CASTROVIEJO Suturing Forceps 4" (10.2 cm), 1 x 2 teeth 0.9 mm, with tying platform
- 18-951** CASTROVIEJO Suturing Forceps 4" (10.2 cm), 1 x 2 teeth 0.3 mm, with tying platform
- 18-952** CASTROVIEJO Suturing Forceps 4" (10.2 cm), 1 x 2 teeth 0.6 mm, with tying platform
- 18-953** CASTROVIEJO Micro Suturing Forceps 4" (10.2 cm), with 11 mm wide handles,
1 x 2 teeth 0.12 mm, with tying platform
- 18-954** CASTROVIEJO Suturing Forceps 4" (10.2 cm), with 11 mm wide handles,
1 x 2 teeth 0.6 mm, with tying platform
- 18-955** CASTROVIEJO Suturing Forceps 4" (10.2 cm), with 11 mm wide handles,
1 x 2 teeth 0.9 mm, with tying platform

For additional Fixation and Suturing Forceps see pages 238, 244 - 248 & 251



21-430



26-1084
26-1086



33-121



18-412
18-414



18-416

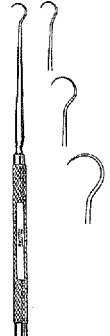

21-85 to 21-87

- 21-430 MILTEX Tissue Twist Hook 5½" (14 cm)
- 26-1084 FRAZIER Skin Hook 5" (12.7 cm), sharp point
- 26-1086 FRAZIER Skin Hook 5" (12.7 cm), blunt point
- 33-121 SELTZER Dermal Biopsy Hook 4½" (11.4 cm), sharp point
- 18-412 TYRELL Skin Hook 5" (12.7 cm), sharp point
- 18-414 TYRELL Skin Hook 5" (12.7 cm), blunt point
- 18-416 GUTHRIE Hook 5" (12.7 cm), sharp double prongs 1.5 mm wide
- 21-85 KLEINERT-KUTZ Hook 5" (12.7 cm), small size 3 mm dia.
- 21-86 KLEINERT-KUTZ Hook 5" (12.7 cm), medium size 5 mm dia.
- 21-87 KLEINERT-KUTZ Hook 5" (12.7 cm), large size 7 mm dia.
- 21-88 GILLIES (CONVERSE) Skin Hook 7" (17.8 cm), large size
- 21-89 GILLIES (CONVERSE) Skin Hook 7" (17.8 cm), small size



21-88
21-89

For additional Hooks see pages 188 - 194



21-90 to 21-94



21-102
21-103



21-144



21-152



21-153

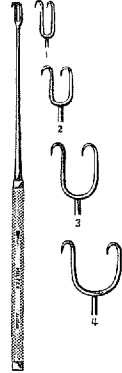

21-154 to 21-160

- 21-90 COTTLE Skin Hook 5½" (14 cm), small, shallow curve
- 21-92 COTTLE Skin Hook 5½" (14 cm), small, deep curve
- 21-94 COTTLE Skin Hook 5½" (14 cm), large, deep curve
- 21-102 FREER Skin Hook 6" (15.2 cm), sharp double prongs 2.5 mm wide
- 21-103 FREER Skin Hook 6" (15.2 cm), blunt double prongs 2.5 mm wide
- 21-144 COTTLE Double Hook 5½" (14 cm), two sharp prongs 12 mm wide
- 21-152 MILTEX Skin Hook 4¾" (12.1 cm), sharp prong 2 mm dia.
- 21-153 JOSEPH Single Hook 6¼" (15.9 cm), one sharp prong
- 21-154 JOSEPH Double Hook 6¼" (15.9 cm), two sharp prongs 2 mm
- 21-156 JOSEPH Double Hook 6¼" (15.9 cm), two sharp prongs 5 mm
- 21-158 JOSEPH Double Hook 6¼" (15.9 cm), two sharp prongs 7 mm
- 21-160 JOSEPH Double Hook 6¼" (15.9 cm), two sharp prongs 10 mm



18-100
18-102



18-439



11D-27

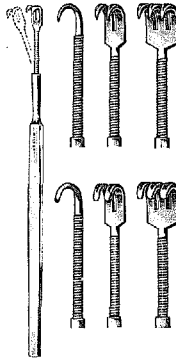

11-30 to 11-40

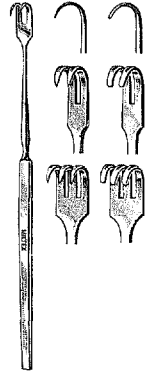

11-50 to 11-60

- 18-100 ROLLET Retractor 5¼" (13.3 cm), with 4 sharp prongs
- 18-102 KNAPP Retractor 5¼" (13.3 cm), with 4 blunt prongs
- 18-439 McGANNON Retractor 5" (12.7 cm), fenestrated blade 2.5 mm wide
- 11D-27 Flexible Neck Rake Retractor 5" (12.7 cm), 3 sharp prongs

RAKE RETRACTORS 6" (15.2 cm)

Sharp	With Flexible Neck	Blunt
11-30	1 prong	11-36
11-32	2 prongs	11-38
11-34	3 prongs	11-40

RAKE RETRACTORS 6" (15.2 cm)

Sharp	With Rigid Neck	Blunt
11-50	1 prong	11-56
11-52	2 prongs	11-58
11-54	3 prongs	11-60

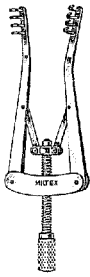

11-12
11-13

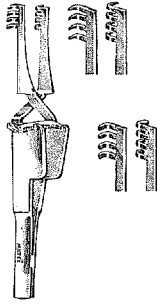

11-14
11-16

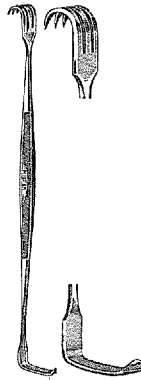

11-74
11-76



11-80
11-81

- 11-12 ALM Retractor 2¾" (7 cm), spread 2¼" (5.7 cm), prongs
¼" (.32 cm) deep
- 11-13 ALM Retractor 3⅞" (9.8 cm), spread 3" (7.6 cm), prongs
½" (1.3 cm) deep
- 11-14 MILTEX Cross Action Retractor 4" (10.2 cm), sharp prongs
- 11-16 MILTEX Cross Action Retractor 4" (10.2 cm), blunt prongs
- 11-74 SENN Retractor 6⅝" (16.2 cm), sharp, double end
- 11-76 SENN Retractor 6⅝" (16.2 cm), blunt, double end
- 11-80 MATHIEU Retractor 6½" (16.5 cm), sharp, double end
- 11-81 MATHIEU Retractor 6½" (16.5 cm), blunt, double end

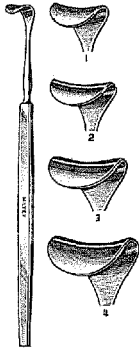

18-110 to 18-116



18-570



33-140
33-142



40-94
40-96

- 18-110** DESMARRES Eye Lid Retractor 5½" (14 cm), size 1, 11 mm
- 18-112** DESMARRES Eye Lid Retractor 5½" (14 cm), size 2, 13 mm
- 18-114** DESMARRES Eye Lid Retractor 5½" (14 cm), size 3, 15 mm
- 18-116** DESMARRES Eye Lid Retractor 5½" (14 cm), size 4, 17 mm
- 18-570** GREEN Spatula 6" (15.2 cm), slightly curved ends 4 x 14 mm and 5 x 16 mm
- 33-140** Finger Ring Cutter 6½" (16.5 cm), with circular saw blade, chrome
- 33-142** Replacement Blade for Finger Ring Cutter, chrome
- 40-94** LOCKE Elevator 4½" (11.4 cm), small blade 3 x 15 mm
- 40-96** LOCKE Elevator 5" (12.1 cm), large blade 5 x 20 mm
- 18-660** Flexible Stainless Ruler 6" (15.2 cm) x ½" (1.3 cm), graduated in ½" (.8 mm) fractions & mm

For Measuring Calipers see page 239



18-660



33-200



33-201
33-202



33-203



33-204
33-206



33-210

- 33-200** SCHAMBERG Comedone Extractor 3¾" (9.5 cm), with square loop ends
- 33-201** SCHAMBERG Comedone Extractor 3¾" (9.5 cm), standard pattern with crimped small loop
- 33-202** SCHAMBERG Comedone Extractor 3¾" (9.5 cm), standard pattern with extra fine loops, small loop crimped
- 33-203** Comedone Extractor 4" (10.2 cm), double end, flat and wire end expressors
- 33-204** SAALFIELD Comedone Extractor 5¼" (14.6 cm), with acne lancet, professional pattern
- 33-206** SAALFIELD Comedone Extractor 4¼" (10.8 cm), with acne lancet, professional pattern
- 33-210** UNNA Comedone Extractor 5¼" (14.6 cm), spoon ends



33-214



33-215
33-216



33-230



33-234



33-232



33-500

- 33-214 MILTEX Comedone Extractor 6" (15.2 cm), one fenestrated cup and one delicate curved lancet with protective cap
- 33-215 GREG Comedone Extractor 5" (12.7 cm), one fenestrated cup and chuck with interchangeable No. 65 lancet blade, protected by cap
- 33-216 Replacement Blade No. 65 for No. 33-215 Comedone Extractor
- 33-230 Finger Nail Drill 4" (10.2 cm), standard pattern, complete with 3 drill points stored in handle
- 33-232 Finger Nail Drill 4½" (11.4 cm), with Chuck Head, complete with 3 drill points stored in handle
- 33-234 Set of 3 Drill Points, small, medium and large size, for Finger Nail Drills, chrome
- 33-500 MILTEX Depilatory Forceps 5¼" (13.3 cm), flat square tips with deep serrations



Dermal Instruments

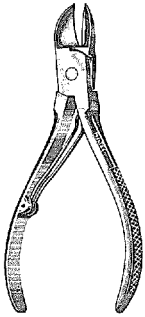

40-200



40-205
40-207

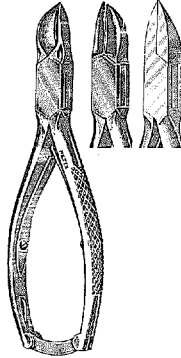

40-210
40-212

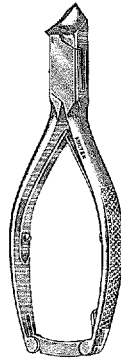

40-215

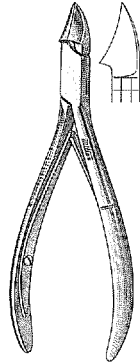

40-217

- 40-200 Nail Nipper 4½" (11.4 cm), concave jaws, single spring, chrome
- 40-205 Nail Nipper 4½" (11.4 cm), concave jaws, barrel spring, chrome
- 40-207 Nail Nipper 5½" (14 cm), concave jaws, barrel spring, chrome
- 40-210-CH Nail Nipper 5½" (14 cm), concave jaws, double spring, chrome
- 40-210-SS Nail Nipper 5½" (14 cm), concave jaws, double spring, stainless
- 40-212-CH Nail Nipper 5½" (14 cm), straight jaws, double spring, chrome
- 40-212-SS Nail Nipper 5½" (14 cm), straight jaws, double spring, stainless
- 40-215-CH Nail Nipper 5½" (14 cm), angled concave jaws, double spring, chrome
- 40-215-SS Nail Nipper 5½" (14 cm), angled concave jaws, double spring, stainless
- 40-217 Nail Nipper 5" (12.7 cm), concave jaws, double spring, stainless
- 40-219 Double Action Nail Nipper 6" (15.2 cm), sharp concave jaws, barrel spring, stainless

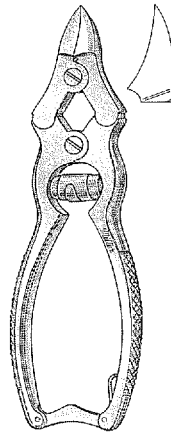

40-219

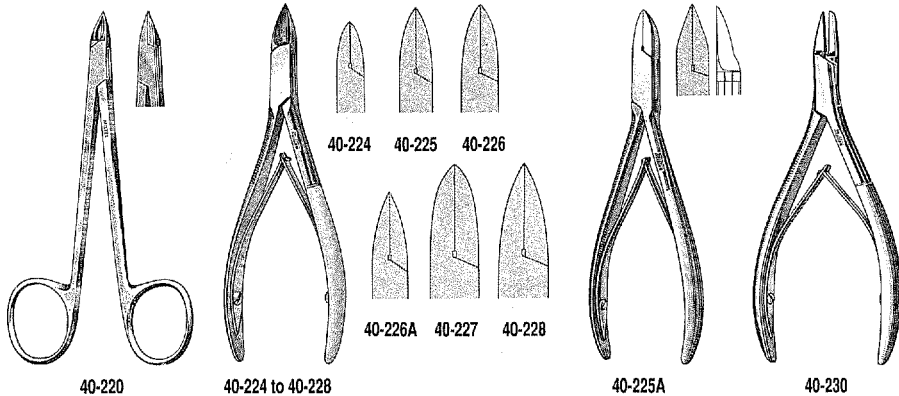

- 40-220** Tissue and Cuticle Nipper 4" (10.2 cm), straight jaws, ring handles, chrome
- 40-224** Nail Splitter 4" (10.2 cm), straight jaws, double spring, stainless
- 40-225A** Nail Splitter 4½" (11.4 cm), delicate straight jaws, double spring, stainless
- 40-225-CH** Nail Splitter 4½" (11.4 cm), straight jaws, single spring, chrome
- 40-225-SS** Nail Splitter 4½" (11.4 cm), straight jaws, double spring, stainless
- 40-226A** Nail Splitter 5" (12.7 cm), straight jaws, extra narrow, double spring, stainless
- 40-226-CH** Nail Splitter 5" (12.7 cm), straight jaws, single spring, chrome
- 40-226-SS** Nail Splitter 5" (12.7 cm), straight jaws, double spring, stainless
- 40-227-CH** Nail Splitter 6" (15.2 cm), straight jaws, single spring, chrome
- 40-227-SS** Nail Splitter 6" (15.2 cm), straight jaws, double spring, stainless
- 40-228** Nail Splitter 6" (15.2 cm), straight jaws, extra narrow, double spring, stainless
- 40-230** Nail Splitter 5" (12.7 cm), English Anvil Pattern, double spring, stainless
- 40-234** PLATYPUS Nail Pulling Forceps 5½" (14 cm), standard wide jaws, stainless
- 40-235** PLATYPUS Nail Pulling Forceps 5½" (14 cm), narrow jaws, stainless

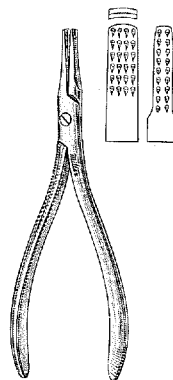

40-234
40-235

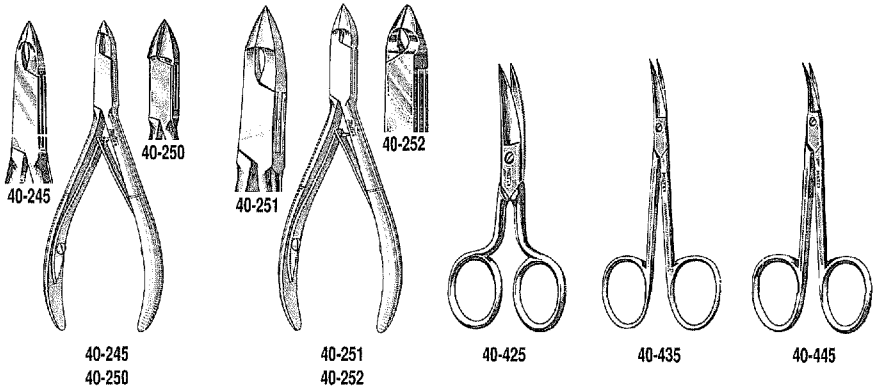

- 40-245-CH** Tissue and Cuticle Nipper 4" (10.2 cm), convex jaws, chrome
- 40-245-SS** Tissue and Cuticle Nipper 4" (10.2 cm), convex jaws, stainless
- 40-250-CH** Tissue and Cuticle Nipper 4½" (11.4 cm), convex jaws, chrome
- 40-250-SS** Tissue and Cuticle Nipper 4½" (11.4 cm), convex jaws, stainless
- 40-251-CH** Tissue and Cuticle Nipper 5" (12.7 cm), convex jaws, chrome
- 40-251-SS** Tissue and Cuticle Nipper 5" (12.7 cm), convex jaws, stainless
- 40-252** Tissue and Cuticle Nipper 5" (12.7 cm), convex jaws, heavy pattern, stainless
- 40-425** Nail Scissors 3½" (8.9 cm), curved blades, chrome
- 40-435** Cuticle Scissors 3½" (8.9 cm), curved blades, standard pattern, chrome
- 40-445** Cuticle Scissors 3½" (8.9 cm), curved blades, extra delicate, chrome
- 40-260** Ingrown Nail Splitting Scissors 6" (15.2 cm), stainless

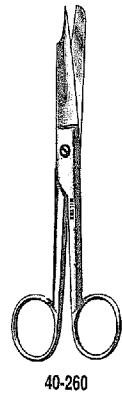



34-50
34-52

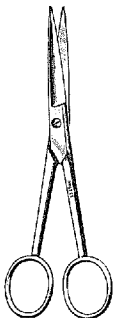

34-80

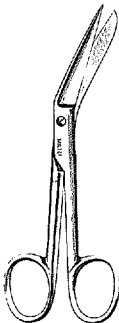

34-92

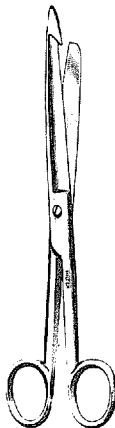

34-98



30-2605

- 34-50 VIRCHOW Brain Sectioning Knife, blade 180 mm x 20 mm, double edge
- 34-52 VIRCHOW Brain Sectioning Knife, blade 250 mm x 40 mm, double edge
- 34-80 Dissecting Scissors 4½" (11.4 cm), straight, two sharp points, economy grade
- 34-92 RICHTER Dissecting Scissors 5" (12.7 cm), angular blades, one sharp and one blunt point
- 34-98 Enterotomy Scissors 8" (20.3 cm), with hook blade
- 30-2605 DUBOIS Scissors 10½" (26.7 cm), curved, blunt points, extra heavy pattern
- 25-360 GLUCK Rib Shears 8½" (21.6 cm)

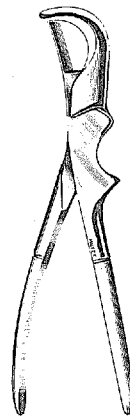

25-360

For a complete selection of Scissors see pages 18 - 52



Post Mortem Instruments

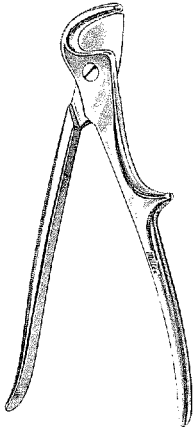

25-362

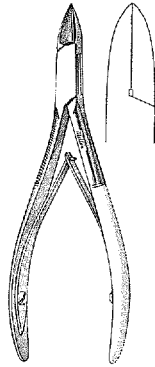

40-227-SS

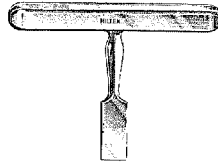

34-210

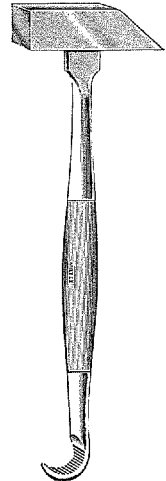

34-220

- 25-362 STILLE Pattern Rib Shears 8½" (21.6 cm)
- 40-227-SS LITTAUER-LISTON Bone Cutting Forceps 6" (15.2 cm), straight 20 mm blades
- 34-210 VIRCHOW Skull Breaker 3" (7.6 cm), blade ½" (1.3 cm) wide
- 34-220 Post Mortem Hammer 9½" (24.1 cm), with hook handle
- 34-250 Dissecting Tenaculum 6½" (16.5 cm), sharp point
- 34-256 Aneurysm Needle 6½" (16.5 cm), blunt tip with eye



34-250



34-256

INDEX

Suggested Surgical Instrument Sets

The following lists have been compiled as a guide in determining basic instrumentation requirements.

	Page Nos.
General Surgery	555-561
Genito-Urinary Surgery	562-564
Rectal Surgery	565-566
Obstetrical and Gynecological Surgery	567-570
Neurosurgery	571-575
Orthopedic Surgery	576-582
Thoracic and Cardiac Surgery	583-588
Ophthalmic Surgery	589-591
Ear, Nose and Throat Surgery	592-596
Suture	597



PLANTA INDUSTRIAL Y OFICINAS GENERALES
Km. 116.5 Autopista México-Puebla C.P. 72730 Puebla, Pue.
Tel./Fax 01 (222) 294-3254 e mail ventas@hemost.com.mx

OFICINA COMERCIAL EN CIUDAD DE MÉXICO
Alfonso Reyes No. 87 Col. Hipódromo Condesa C.P. 06170
Delegación Cuauhtémoc, México D.F. Tels. 01 (55) 5277-5655
5277-5242 Fax (55) 5277-5127 e mail ventas_mexico@hemost.com.mx